

CIPCA Adapter Installation and User's Guide

Order Number EK-CIPCA-UG. C01

This manual is intended for network technical and installation personnel, system managers, and system operators. This manual covers basic installation and operation of the CIPCA adapter in the AlphaServer systems that support it.

**Digital Equipment Corporation
Maynard, Massachusetts**

First Printing, February 1996

Revised, July 1996

Revised March 1997

Digital Equipment Corporation makes no representations that the use of its products in the manner described in this publication will not infringe on existing or future patent rights, nor do the descriptions contained in this publication imply the granting of licenses to make, use, or sell equipment or software in accordance with the description.

The information in this document is subject to change without notice and should not be construed as a commitment by Digital Equipment Corporation.

Digital Equipment Corporation assumes no responsibility for any errors that may appear in this document.

The software, if any, described in this document is furnished under a license and may be used or copied only in accordance with the terms of such license. No responsibility is assumed for the use or reliability of software or equipment that is not supplied by Digital Equipment Corporation or its affiliated companies.

Copyright © 1997 by Digital Equipment Corporation.

All Rights Reserved.

Printed in U.S.A.

The following are trademarks of Digital Equipment Corporation: AlphaGeneration, AlphaServer, OpenVMS, VAX, the AlphaGeneration logo, and the DIGITAL logo.

UNIX is a registered trademark in the U.S. and other countries, licensed exclusively through X/Open Company Ltd.

FCC Notice: The equipment described in this manual generates, uses, and may emit radio frequency energy. The equipment has been type tested and found to comply with the limits for a Class A digital device pursuant to Part 15 of FCC Rules, which are designed to provide reasonable protection against such radio frequency interference. Operation of this equipment in a residential area may cause interference, in which case the user at his own expense will be required to take whatever measures are required to correct the interference.

Shielded Cables: If shielded cables have been supplied or specified, they must be used on the system in order to maintain international regulatory compliance.

European Common Market:

Warning! This is a Class A product. In a domestic environment this product may cause radio interference, in which case the user may be required to take adequate measures.

Actung! Dieses ist ein Gerät der Funkstörgrenzwertklasse A. In Wohnbereichen können bei Betrieb dieses Gerätes Rundfunkstörungen auftreten, in welchen Fällen der Benutzer für entsprechende Gegenmaßnahmen verantwortlich ist.

Avertissement! Cet appareil est un appareil de Classe A. Dans un environnement résidentiel, cet appareil peut provoquer des brouillages radioélectriques. Dans ce cas, il peut être demandé à l'utilisateur de prendre les mesures appropriées.

Contents

Preface.....vii

Chapter 1 - Introduction

- 1.1 In This Chapter..... 1-1
- 1.2 Hardware System Support 1-1
- 1.3 Operating System Support 1-1
- 1.4 CIPCA Variants..... 1-1
- 1.5 Physical Description 1-2
- 1.6 Technical Data 1-3
- 1.7 Functional Overview 1-4
- 1.8 System Requirements 1-5

Chapter 2 - Installing CIPCA Adapters

- 2.1 In This Chapter..... 2-1
- 2.2 Installation Overview 2-1
- 2.3 Contents of the CIPCA Adapter Kit 2-1
- 2.4 Installation..... 2-4
 - 2.4.1 Shut Down Power..... 2-4
 - 2.4.2 Set the Link Module DIP Switches..... 2-4
 - 2.4.3 Attach Extender Bracket 2-7
 - 2.4.4 Install the CIPCA Modules..... 2-9
 - 2.4.5 Connect the Intermodule Ribbon Cables 2-22
 - 2.4.6 Connect the External Cables 2-23
 - 2.4.7 Close the System Unit and Reconnect Power Cord..... 2-24
 - 2.4.8 Power on the System and Peripherals 2-24

Chapter 3 - Using CIPCA

- 3.1 In This Chapter..... 3-1
- 3.2 AlphaServer 8200/8400 Systems 3-1
 - 3.2.1 Power-Up Display 3-2
 - 3.2.2 Show Config Command 3-3
 - 3.2.3 Show Device Command 3-4
- 3.3 AlphaServer 4000/4100 Systems 3-5
 - 3.3.1 Power-Up Display 3-5
 - 3.3.2 Show Config Command 3-6
 - 3.3.3 Show Device Command 3-8
- 3.4 AlphaServer 2100/2100A Systems..... 3-9
 - 3.4.1 Power-Up Display 3-9

3.4.2 Show Config Command	3-10
3.4.3 Show Device Command	3-12
3.5 AlphaServer 2000 Systems	3-14
3.5.1 Power-Up Display	3-14
3.5.2 Show Config Command	3-16
3.5.3 Show Device Command	3-17
3.6 Booting Disks Using CIPCA.....	3-18
3.6.1 Displaying Boot Information	3-18
3.6.2 Simple Boot	3-18
3.6.3 Setting CIPCA as the Default Boot Device.....	3-19
3.6.4 Setting Multiple CIPCAs as Default Boot Devices in Multicontroller Systems	3-19
3.6.5 Setting CIPCA to Boot Automatically in Single or Multicontroller Systems	3-20
3.6.6 Bootstrap Procedure Output	3-21

Chapter 4 - Updating Firmware

4.1 In This Chapter.....	4-1
4.2 Firmware Updates	4-1
4.3 Firmware Update Procedure Overview	4-3
4.3.1 LFU Filenames.....	4-4
4.4 Firmware Update Examples.....	4-5
4.4.1 Updating AlphaServer 8200/8400 Firmware.....	4-5
4.4.2 Updating AlphaServer 4000/4100 Firmware.....	4-9
4.4.3 Updating AlphaServer 2000/2100/2100A Firmware	4-11

Chapter 5 - Troubleshooting

5.1 In This Chapter 5-1
5.2 Reading LEDs 5-1
5.3 Advanced Troubleshooting 5-8

Appendix A - Specifications

Appendix B - Registers

Appendix C - DECEvent Examples

Index

Preface

Introduction

This document explains how to install, configure, and use a CIPCA adapter. CIPCA enables PCI to CI connectivity for AlphaServer 8200/8400, 4000/4100, 2100, 2100A, and 2000 systems.

Using CIPCA in AlphaServer systems provides high-availability computing and access to shared storage.

Audience

This guide is intended for system managers and others who are responsible for managing and upgrading AlphaServer 8200/8400, 4000/4100, 2100, 2100A, and 2000 systems.

Related Documentation

Table 1 contains a list of related documentation for the AlphaServer 8200/8400, 4000/4100, 2100, 2100A, and 2000 systems.

Table 1 Related Documentation

Title	Order Number
AlphaServer 8200/8400 Hardware User Information and Installation	
<i>Operations Manual</i>	EK-T8030-OP
<i>Site Preparation Guide</i>	EK-T8030-SP
<i>AlphaServer 8200 Installation Guide</i>	EK-T8230-IN
<i>AlphaServer 8400 Installation Guide</i>	EK-T8430-IN
Reference Manuals	
<i>System Technical Manual</i>	EK-T8030-TM
<i>DWLPA and DWLPB PCI Adapter Technical Manual</i>	EK-DWLPX-TM
Upgrade Manuals for Both Systems	
<i>KN7CC CPU Installation Card</i>	EK-KN7CC-IN
<i>KN7CD CPU Installation Card</i>	EK-KN7CD-IN
<i>KN7CE CPU Installation Card</i>	EK-KN7CE-IN
<i>MS7CC Memory Installation Card</i>	EK-MS7CC-IN
<i>KFTHA System I/O Module Installation Card</i>	EK-KFTHA-IN
<i>KFTIA Integrated I/O Module Installation Card</i>	EK-KFTIA-IN
Upgrade Manuals: 8200 System Only	
<i>DWLPA/DWLPB PCI Shelf Installation Guide</i>	EK-DWL82-IN
<i>H7266 Power Regulator Installation Card</i>	EK-H7266-IN
<i>H7267 Battery Backup Installation Card</i>	EK-H7267-IN
Upgrade Manuals: 8400 System Only	
<i>AlphaServer 8400 Upgrade Manual</i>	EK-T8430-IN
<i>AlphaServer 8200 to 8400 Upgrade Manual</i>	EK-T8284-UI
<i>BA654 DSSI Disk PIU Installation Guide</i>	EK-BA654-IN
<i>BA655 SCSI Disk and Tape PIU Installation Guide</i>	EK-BA655-IN
<i>DWLMA XMI PIU Installation Guide</i>	EK-DWLMA-IN

<i>DWLPA/DWLPB PCI PIU Installation Guide</i>	EK-DWL84-IN
<i>H7237 Battery PIU Installation Guide</i>	EK-H7237-IN
<i>H7263 Power Regulator Installation Card</i>	EK-H7263-IN
<i>KFMSB Adapter Installation Guide</i>	EK-KFMSB-IN
<i>KZMSA Adapter Installation Guide</i>	EK-KXMSX-IN
<i>RRDCD Installation Guide</i>	EK-RRDRX-IN
System I/O Options	
<i>KZPSA PCI to SCSI User's Guide</i>	EK-KZPSA-UG
<i>StorageWorks RAID Array 200 Subsystem Family Software User's Guide for OpenVMS Alpha</i>	AA-Q6WVA-TE
AlphaServer 4000/4100 Hardware User Information and Installation	
<i>AlphaServer 4000/4100 Configuration and Installation Guide</i>	EK-4100A-CG
<i>AlphaServer 4100 System Drawer User's Guide</i>	EK-4100A-UG
<i>AlphaServer 4000 System Drawer User's Guide</i>	EK-4000A-UG
<i>AlphaServer 4100 Service Manual</i>	EK-4100A-SV
<i>AlphaServer 4100 Service Manual (diskette)</i>	AK-QXBJA-CA
AlphaServer 2000/2100/2100A Hardware User Information and Installation	
<i>AlphaServer 2000 Owner's Guide</i>	EK-400MP-OP
<i>AlphaServer 2100 Owner's Guide</i>	EK-KN450-OP
<i>AlphaServer 2100A Owner's Guide</i>	EK-2100A-OP
<i>AlphaServer 2000/2100/2100A Firmware Reference Guide</i>	EK-AXPFW-RM
<i>AlphaServer 2000/2100/2100 RM/ 2100 CAB Series Service Guide</i>	EK-KN450-SV
<i>AlphaServer 2100A Service Guide</i>	EK-2100A-SV
<i>AlphaServer 2100A RM Series Installation/Owner's Guide</i>	EK-2100A-RM
<i>AlphaServer 2100 RM Series Installation/Owner's Guide</i>	EK-KN450-RM
<i>AlphaServer 2100 CAB Installation/Owner's Guide</i>	EK-ALCAB-OG

HSJ Documentation

HS Family User's Guide (includes HSJ) EK-HSFAM-UG

HS Family Service Manual EK-HSFAM-SV

DECevent Documentation

DECevent Release Notes for OpenVMS AA-Q73LA-TE

DECevent Analysis and Notification Utility for OpenVMS AA-Q73LD-TE

DECevent Translation and Reporting Utility for OpenVMS AA-Q73KD-TE

The DECevent Graphical User Interface User's Guide AA-QE26B-TE

Miscellaneous

StorageWorks Product Information, Catalog, and More <http://www.storage.digital.com>

OpenVMS Cluster Software Information, including OpenVMS Software Product Description (V6.2-1H3 and V7.1) <http://www.openvms.digital.com/openvms/products/clusters/index.html>

Chapter 1

Introduction

1.1 In This Chapter

This chapter introduces the CIPCA PCI-to-CI Storage Host Adapter. The CIPCA adapter allows users to connect CI-based storage to high-performance PCI-based AlphaServer systems. By participating in an OpenVMS cluster, AlphaServer systems provide high-availability computing and access to shared storage like the HSJ and HSC RAID controllers. This chapter includes the following topics:

- Systems Supporting CIPCA
- CIPCA Variants
- Physical Description
- Technical Data
- Functional Overview
- System Requirements

1.2 Hardware System Support

The CIPCA adapter is supported on the following AlphaServer systems:

- AlphaServer 8200/8400
- AlphaServer 4000/4100
- AlphaServer 2000/2100/2100A

1.3 Operating System Support

The CIPCA adapter is supported on the OpenVMS operating system. Refer to the following World Wide Web site for detailed OpenVMS support information:

www.openvms.digital.com/openvms/products/clusters/index.html

1.4 CIPCA Variants

There are two variants of the CIPCA adapter, the CIPCA-AA and the CIPCA-BA.

- The CIPCA-AA consists of a module that plugs into an expansion slot in the PCI bus and a module that plugs into an expansion slot in the EISA bus.
- The CIPCA-BA consists of two modules that plug into expansion slots in the PCI bus.

1.5 Physical Description

The CIPCA adapter consists of the following components:

- **Port Module** - the primary interface to the host. The port module plugs into an expansion slot in the PCI bus.
- **Link Module** - the physical interface between the AlphaServer system and the CI cluster.

The **CIPCA-AA link module** plugs into an expansion slot in the EISA bus. The link module uses only the power pins in the EISA slot, not the bus. Because the link module is not logically connected to EISA, the EISA Configuration Utility need not be used when adding a CIPCA to an AlphaServer. For 8200/8400 systems, the PCI-EISA bridge option (KFE70) is not required.

The **CIPCA-BA link module** plugs into an expansion slot on the PCI bus. The link module uses only the power pins in the PCI slot, not the bus.

- **Ribbon Cables** - interconnect the port and link modules. These cables are internal to the cabinet that contains the PCI and EISA buses. This pair of cables is approximately 23 cm (9 in.) in length.
- **CI Transition Cable** - The CI transition cable attaches to the backplate of the link module and to one end of the BNCIA cable set. The other end of the BNCIA cable set connects to the CI star coupler. The transition cable is approximately 2 m (6 ft.) in length.

1.6 Technical Data

Technical data for the CIPCA adapter is described below.

Supported Configurations	CIPCA is supported using the current V6.2/V7.1 OpenVMS cluster and OpenVMS SPD CI configuration rules. Refer to: www.openvms.digital.com/openvms/products/clusters/index.html
CIPCA Host Systems	AlphaServer 8200, 8400, 4000, 4100, 2100, 2100A, and 2000. <ul style="list-style-type: none">• The CIPCA-AA adapter requires one PCI backplane slot and one EISA backplane slot.• The CIPCA-BA adapter requires two PCI backplane slots.
CI Connected Hosts Supported	Any VAX or Alpha VMS host using a CIPCA, CIXCD, or CIBCA-B adapter.
CI Hierarchical Storage Controllers Supported	- HSJ with HSOF v2.5 or higher - All HSC6x/9x - HSC40/70 with Revision F or higher L0109 modules - Not supported with HSC50
CI Host Adapters Supported	CIPCA, CIXCD, CIBCA-B
OpenVMS VAX/Alpha Versions	Standard "Warranted" and "Migration" pairings for mixed architecture/version clusters apply. Refer to: www.openvms.digital.com/openvms/products/clusters/index.html

1.7 Functional Overview

The CIPCA adapter provides functionality in the following areas:

Memory Utilization	Direct Memory Access
	Mapped Direct Memory Access
Data Transmission Services	Virtual Circuit Service
	Datagrams
	Messages
	Block Data Transfers
	Configuration Operations
	Maintenance Operations
Other Features	Dual Data Path
	Up to 4 Kbyte packet sizes (CI packets)
	Synchronous CI arbitration

1.8 System Requirements

Review the system software requirements listed below before you begin the installation.

Table 1-1 CIPCA Requirements

	Software/ Hardware	Minimum Required Revision Level
Operating System	OpenVMS	CIPCA-AA: V6.2-1H2 and subsequent releases of V6.2. CIPCA-AA is not supported by V7.0, but is supported by V7.1 and higher. CIPCA-BA: V7.1 and higher
Firmware	8200/8400 console code	V3.0 or higher
	4000 console code	V3.0 or higher
	4100 console code	V1.2-4 or higher
	2000, 2100, and 2100A console code	V4.4 or higher
Controllers	HSJ	HSOF v2.5 or higher
	HSC6x and HSC9x	All
	HSC 40 and HSC 70	L0109 must be Revision F or higher
	HSC50	Not supported

Chapter 2

Installing CIPCA Adapters

2.1 In This Chapter

This chapter describes the installation procedure for the CIPCA adapter in AlphaServer 8200/8400, 4000/4100, 2000, 2100, and 2100A systems. This chapter covers the following topics:

- Installation Overview
- Contents of the CIPCA Adapter Kit
- Installation

2.2 Installation Overview

This section provides an overview of the installation procedure. Each step of the procedure is detailed in the remainder of the chapter.

1. Perform power shutdown.
2. Set link module DIP switches.
3. Attach the PCI extender bracket to the port module, if CIPCA-AA and to the port and link modules, if CIPCA-BA.
4. Remove slot covers from EISA and PCI slots.
5. Install the CIPCA modules.
6. Connect the external cables.
7. Close the system unit and reconnect the power cord.
8. Power on the system and peripherals.

2.3 Contents of the CIPCA Adapter Kit

Table 2-1 lists the items in the CIPCA-AA adapter kit, and Table 2-2 lists the items in the CIPCA-BA adapter kit. Verify that you have received all the items in your kit before proceeding. Contact your sales representative if any kit items are missing. Table 2-3 lists the part numbers of the BNCIA cable sets that must be ordered separately.

Table 2-1 Contents of CIPCA-AA Adapter Kit

Quantity	Part Number	Description
1	CIPCA-AX ¹	
	30-46980-01	Link module (EISA-6610)
	30-46980-02	Port processor module (PCI-6600)
2	17-04366-01	Two 60-pin intermodule ribbon cables
1	17-03427-01	2 m (6 ft.) CI transition cable
1	74-47802-01	PCI, slot-offset extender bracket with
2	90-09643-02	Screw, SEMS 4-40 Pan .250 XRCS
1	74-49920-02	PCI, straight extender bracket with
2	90-09984-20	Screw, SEMS M3 Pan 6 mm RCS CSZ
1	EK-CIPCA-UG	<i>CIPCA Installation and User's Guide</i>
1	EK-CIPCA-RN	<i>CIPCA Adapter Release Notes</i>

¹ Both modules must be ordered when replacing adapter.

2-2 CIPCA Adapter Installation and User's Guide

Table 2-2 Contents of CIPCA-BA Adapter Kit

Quantity	Part Number	Description
1	CIPCA-BX ¹	
	30-46980-03	Link module
	30-46980-02	Port processor module (PCI-6600)
2	17-04366-02	Two 60-pin intermodule ribbon cables
1	17-03427-01	2 m (6 ft.) CI transition cable
2	74-47802-01	PCI, slot-offset extender bracket with
4	90-09643-02	Screw, SEMS 4-40 Pan .250 XRCS
2	74-49920-02	PCI, straight extender bracket with
4	90-09984-20	Screw, SEMS M3 Pan 6 mm RCS CSZ
1	EK-CIPCA-UG	<i>CIPCA Installation and User's Guide</i>
1	EK-CIPCA-RN	<i>CIPCA Adapter Release Notes</i>

¹ Both modules must be ordered when replacing adapter.

Table 2-3 CIPCA Cable Sets

Quantity	Part Number	Description
1	BNCIA-10	External BNCIA cable set - 10 m (33 ft.)*
1	BNCIA-20	External BNCIA cable set - 20 m (65.5 ft.)*
1	BNCIA-45	External BNCIA cable set - 45 m (147.5 ft.)*

* Note that each BNCIA cable set consists of four separate coaxial cables.

Other Tools Needed

Phillips-head screwdriver (user-supplied)

2.4 Installation

Perform the following steps to install the CIPCA adapter.

2.4.1 Shut Down Power

1. Perform an orderly shutdown of the operating system.
2. Set all power switches on the system and peripherals to the “off” position.
3. Unplug all power cords from the wall socket, then disconnect the cord from the system unit.
4. Remove the cover or panels from the system unit to access the PCI and EISA slots. Refer to the appropriate system documentation if necessary.

2.4.2 Set the Link Module DIP Switches

Before installing the link module, you must set the DIP switches for node ID and cluster size. Figure 2-1 shows the location of the DIP switches.

CAUTION: Static electricity can damage electronic components. Use an antistatic wrist strap while handling the components.

Figure 2-1 Location of DIP Switches on Link Module

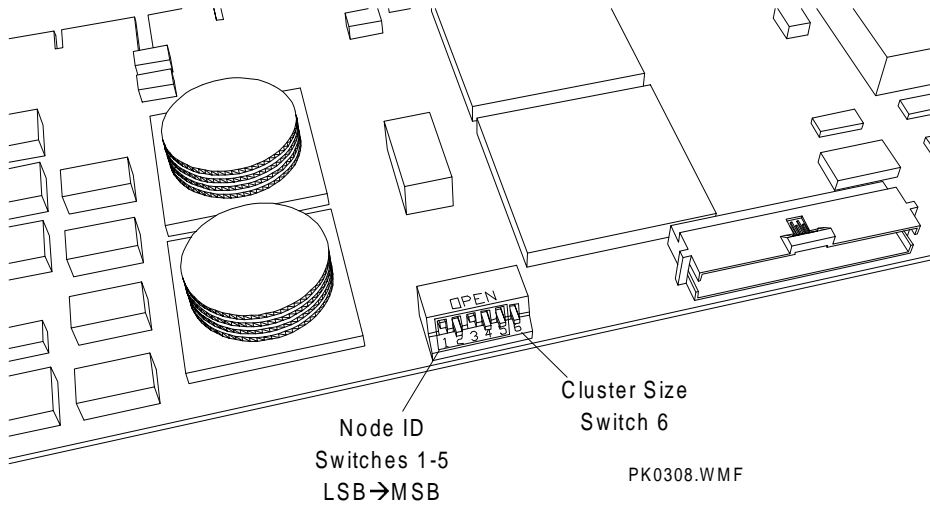

Figure 2-2 shows the open and closed switch positions and shows the DIP switch set for node ID 5 in a 16-node cluster. Switches 1 through 5 set the node identification. Switch 6 sets the cluster size. Table 2-4 shows the switch positions for setting the node ID for the CIPCA host system. Node numbers are binary encoded with the most significant bit (MSB) on the right.

Figure 2-2 Sample Switch Setting for Node ID 5 in a 16-Node Cluster

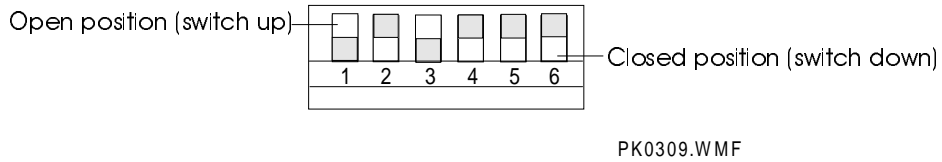

Table 2-4 Node ID Switch Settings on Link Module

Node ID	SW1	SW2	SW3	SW4	SW5
0	Closed	Closed	Closed	Closed	Closed
1	Open	Closed	Closed	Closed	Closed
2	Closed	Open	Closed	Closed	Closed
3	Open	Open	Closed	Closed	Closed
4	Closed	Closed	Open	Closed	Closed
5	Open	Closed	Open	Closed	Closed
6	Closed	Open	Open	Closed	Closed
7	Open	Open	Open	Closed	Closed
8	Closed	Closed	Closed	Open	Closed
9	Open	Closed	Closed	Open	Closed
10	Closed	Open	Closed	Open	Closed
11	Open	Open	Closed	Open	Closed
12	Closed	Closed	Open	Open	Closed
13	Open	Closed	Open	Open	Closed
14	Closed	Open	Open	Open	Closed
15	Open	Open	Open	Open	Closed
16	Closed	Closed	Closed	Closed	Open
17	Open	Closed	Closed	Closed	Open
18	Closed	Open	Closed	Closed	Open
19	Open	Open	Closed	Closed	Open
20	Closed	Closed	Open	Closed	Open
21	Open	Closed	Open	Closed	Open
22	Closed	Open	Open	Closed	Open
23	Open	Open	Open	Closed	Open
24	Closed	Closed	Closed	Open	Open
25	Open	Closed	Closed	Open	Open
26	Closed	Open	Closed	Open	Open
27	Open	Open	Closed	Open	Open
28	Closed	Closed	Open	Open	Open
29	Open	Closed	Open	Open	Open
30	Closed	Open	Open	Open	Open
31	Open	Open	Open	Open	Open

Table 2-5 shows the options for setting cluster size. Guidelines for setting cluster size are as follows:

- Set all nodes in the cluster to the same size.
- If the cluster contains 16 or fewer nodes, set the cluster size to 16.

Table 2-5 Setting Size of Node Cluster on DIP Switch

Cluster Size	SW6
16-node cluster	Closed
32-node cluster	Open

2.4.3 Attach Extender Bracket

- Attach a PCI extender bracket to the port module, if installing CIPCA-AA. Refer to Table 2-6 for the appropriate type of bracket for your system.
- Attach PCI extender brackets to the port module and the link module, if installing CIPCA-BA. Refer to Table 2-6 for the appropriate type of bracket for your system.

Table 2-6 PCI Extender Bracket Specifications for AlphaServer Systems

AlphaServer Model	Straight Extender Bracket (p/n 74-49920-02)	Slot-Offset Extender Bracket (p/n 74-47802-01)
8400	✓	
8200	✓	
4000		✓
4100		✓
2100	✓	
2100A		✓
2000	✓	

Figure 2-3 shows the installation position of the PCI straight extender bracket. Figure 2-4 shows the installation position of the PCI offset extender bracket.

Figure 2-3 PCI Module Straight Extender Bracket Installation

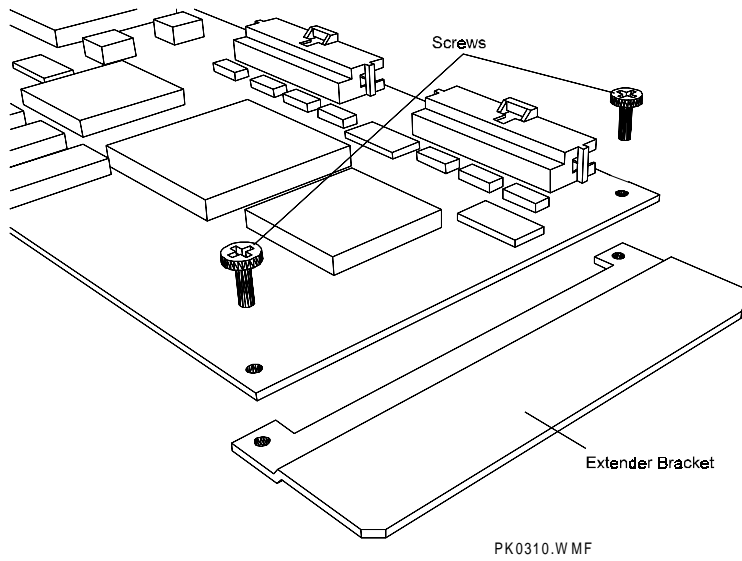
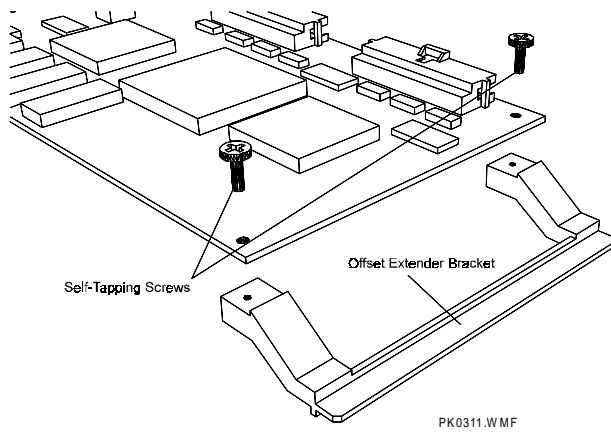

Figure 2-4 PCI Module Offset Extender Bracket Installation



2.4.4 Install the CIPCA Modules

The AlphaServer systems that support CIPCA have different installation and placement rules. CIPCA installation procedures for each system are described in the subsections that follow.

CAUTION: Intermodule ribbon cables should always be dressed to lay over the module handles. Do not tuck excess cable between modules. Tucking the excess cable between modules can block airflow and cause overheating.

2.4.4.1 Installing CIPCA in AlphaServer 8200/8400 Systems

In AlphaServer 8400s, CIPCA modules plug into vertically mounted plug-in units (DWLPA or DWLPB). Each DWLPA has 12 expansion slots and can hold a mixture of PCI and EISA modules. In AlphaServer 8200s, CIPCAs plug into horizontally mounted PCI shelves (DWLPA or DWLPB).

Table 2-7, Figure 2-5, and Figure 2-6 show the recommended slot locations for installing CIPCA-AA in 8200/8400 systems. In vertically mounted DWLPA or DWLPB units (8400), count slots from the bottom up starting with Slot 0. In horizontally mounted DWLPA/B units (8200), count slots from right to left starting with Slot 0.

Table 2-7 CIPCA-AA in AlphaServer 8200/8400

Preferred Location	Port Module	Link Module
First Choice	Slot 4 (PCI)	Slot 3 (EISA Slot 2)
Second Choice	Slot 6 (PCI)	Slot 5 (EISA Slot 3)
Third Choice	Slot 8 (PCI)	Slot 7 (EISA Slot 4)
Fourth Choice	Slot 10 (PCI)	Slot 9 (EISA Slot 6)

NOTE: The CIPCA-BA modules can be installed in any two adjacent PCI slots on 8200/8400 systems.

Figure 2-5 CIPCA-AA in AlphaServer 8400

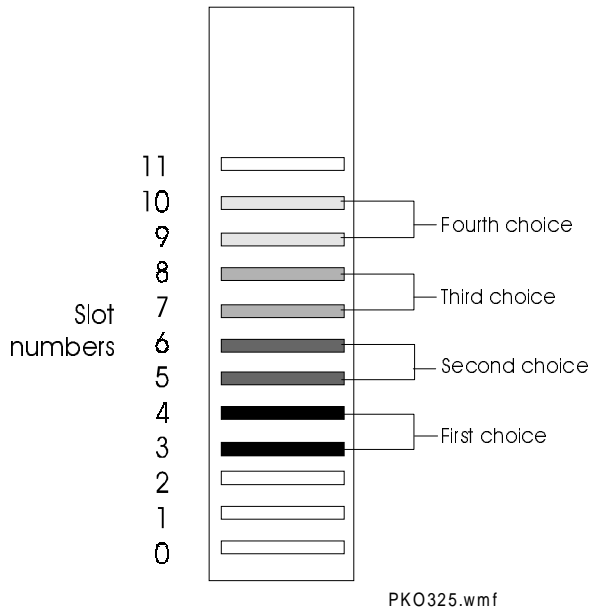
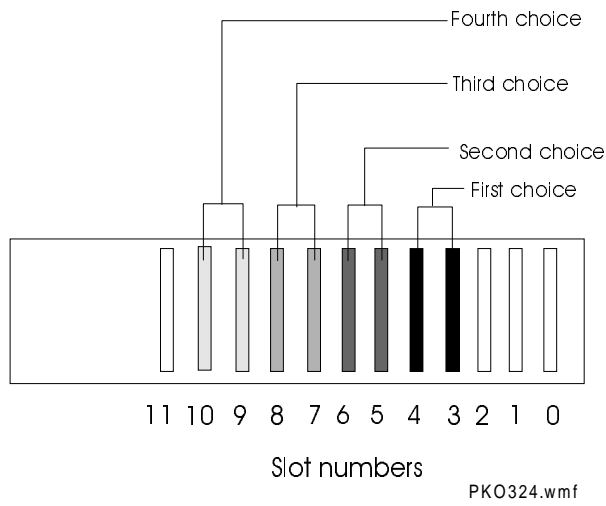

Figure 2-6 CIPCA-AA in AlphaServer 8200



To install the CIPCA modules in the AlphaServer 8200/8400, perform the following steps:

1. Attach a PCI straight extender bracket (part number 74-49920-02) to the port module, if installing CIPCA-AA. Attach straight extender brackets to the port and link modules, if installing CIPCA-BA.
2. Locate the DWLPA or DWLPB PCI shelf on the system unit. Any DWPLA or DWLPB can be used.
3. Locate the slots where the modules will be installed.

NOTE: PCI slots are shorter than EISA slots.

4. Remove the blank backplates from the backplane of the shelf.
5. Follow these guidelines when installing CIPCA in an AlphaServer 8200/8400:
 - Install the link module in an EISA slot, if CIPCA-AA, or install it in a PCI slot, if CIPCA-BA.
 - Install the port module in a PCI slot.
 - Install CIPCA modules in adjacent slots, if possible.
 - Install the port module in the higher slot number next to the link module.
6. Starting with either module, align the gold contacts on the module with the appropriate slot on the motherboard and press the module firmly into the socket.
7. Screw the module bracket into the backplane frame to secure the module.
8. Proceed to Section 2.4.5.

2.4.4.2 Installing CIPCA in AlphaServer 4000/4100 Systems

In AlphaServer 4000/4100s, CIPCA modules plug into the PCI card cage. Table 2-8 lists the recommended slot locations, and Figure 2-7 illustrates the recommended slots for the CIPCA-AA.

Note: The CIPCA-BA modules can be installed in any two adjacent PCI slots on AlphaServer 4000/4100 systems.

Table 2-8 CIPCA-AA in AlphaServer 4000/4100 Systems

Preferred Location	Port Module	Link Module
First Choice	PCI0 slot 5	EISA slot 3 (PCI0 slot 4)
Second Choice	PCI0 slot 3 (EISA slot 2)	EISA slot 1 (PCI0 slot 2)

NOTE: In an AlphaServer 4000, the CIPCA-AA can be installed only in the PCI/EISA bus motherboard (B3050), which has EISA slots. The CIPCA-BA can be installed in either PCI bus motherboard.

The locations indicated in Table 2-8 are for the first CIPCA-AA module. If you are installing a second CIPCA-AA module, install the link module in EISA slot 2 and the port module in PCI0 slot 2.

Figure 2-7 CIPCA-AA in AlphaServer 4000/4100

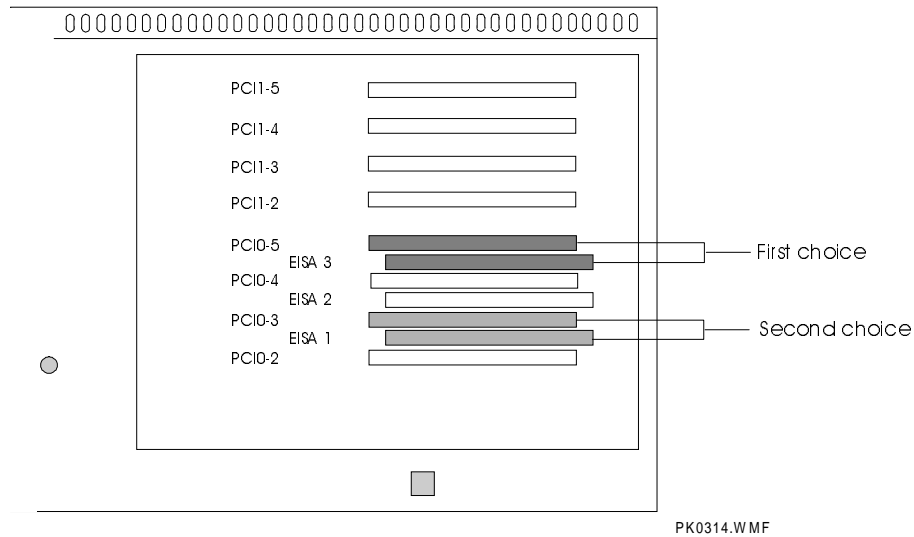

To install the CIPCA modules in the AlphaServer 4000/4100, perform the following steps:

1. Attach a PCI slot-offset extender bracket (part number 74-47802-01) to the PCI module, if installing CIPCA-AA. Attach offset extender brackets to the port and link modules, if installing CIPCA-BA.
2. Locate the slots where the modules will be installed.

NOTE: PCI slots are shorter than EISA slots.

3. Remove the blank backplates from the backplane of the system enclosure.
4. Follow these guidelines when installing CIPCA into an AlphaServer 4000/4100 system:
 - Install the link module in an EISA slot, if CIPCA-AA, or install it in a PCI slot, if CIPCA-BA.
 - Install the port module in a PCI slot directly above the link module.
5. Starting with either module, align the gold contacts on the modules with the appropriate slots on the motherboard and press the modules firmly into the connector.
6. Screw the bracket into the backplane frame to secure the modules in place.
7. Proceed to Section 2.4.5.

2.4.4.3 Installing CIPCA in AlphaServer 2100 Systems

An AlphaServer 2100 motherboard has eight EISA slots, three PCI slots, and a standard I/O module. Table 2-9 and Figure 2-8 show the recommended slot locations for installing CIPCA-AA in AlphaServer 2100 systems.

Table 2-9 CIPCA-AA in AlphaServer 2100

Preferred Location	Port Module	Link Module
First Choice	PCI Slot 1	EISA Slot 2
Second Choice	PCI Slot 2	EISA Slot 3

NOTE: The CIPCA-BA modules can be installed in any two adjacent PCI slots on AlphaServer 2100 systems.

Figure 2-8 CIPCA-AA in AlphaServer 2100

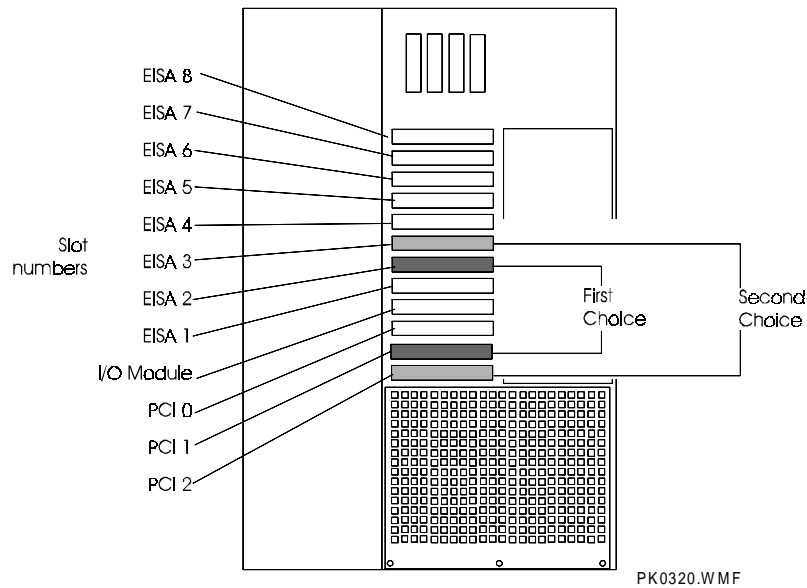

To install the CIPCA modules in the AlphaServer 2100, perform the following steps:

1. Locate the slots where the modules will be installed.

NOTE: PCI slots are shorter than EISA slots.

2. Remove the blank backplates from the backplane of the system unit.
3. Attach a PCI straight extender bracket (part number 74-49920-02) to the port module, if installing CIPCA-AA. Attach PCI straight extender brackets to the port and link modules, if installing CIPCA-BA.
4. Follow these guidelines when installing CIPCA into an AlphaServer 2100 system:
 - Install the link module in an EISA slot, if CIPCA-AA, or install it in a PCI slot, if CIPCA-BA.
 - Install the port module in a PCI slot. PCI and EISA slots are labeled inside the unit.
5. Starting with either module, align the gold contacts on the module with the appropriate slot on the motherboard and press the module firmly into place.
6. Screw the bracket into the backplane frame to secure the modules in place.
7. Proceed to Section 2.4.5.

2.4.4.4 Installing CIPCA in AlphaServer 2100A Systems

An AlphaServer 2100A motherboard has three EISA slots and eight PCI slots. Table 2-10, Figure 2-9 and Figure 2-10 show the recommended slot locations for installing CIPCA-AA in AlphaServer 2100A systems.

Table 2-10 CIPCA-AA in AlphaServer 2100A

Preferred Location	Port Module	Link Module
First Choice	PCI Slot 0	EISA Slot 1
Second Choice	PCI Slot 1	EISA Slot 2

NOTE: For the CIPCA-BA variant, it is recommended that you install the modules on the secondary PCI bus (PCI 0 through PCI 3), reserving the primary PCI bus for latency-sensitive devices such as the CCMAA MEMORY CHANNEL adapter.

Figure 2-9 CIPCA-AA in AlphaServer 2100A

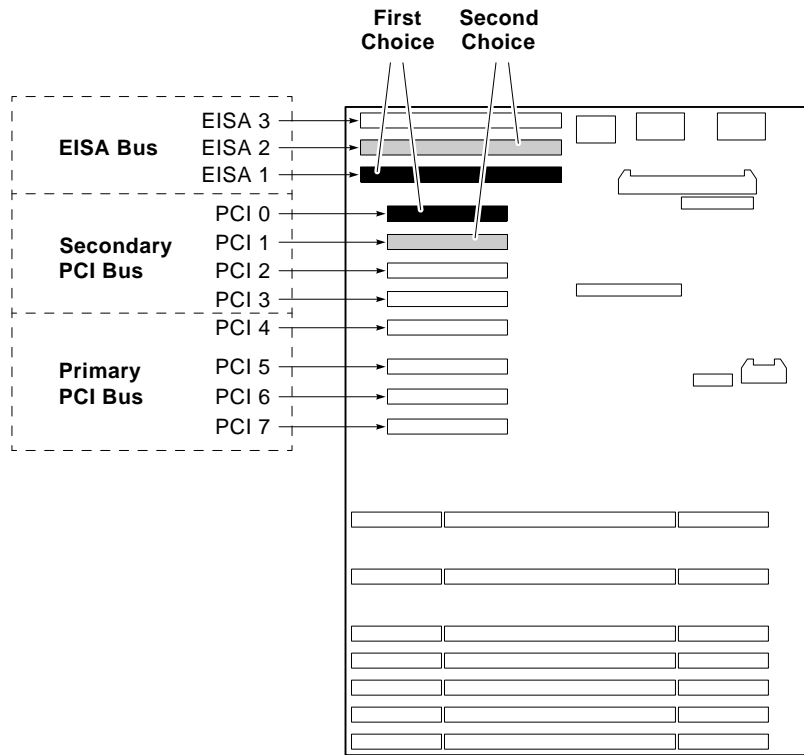

MA00859A

Figure 2-10 CIPCA-AA in AlphaServer 2100A RM

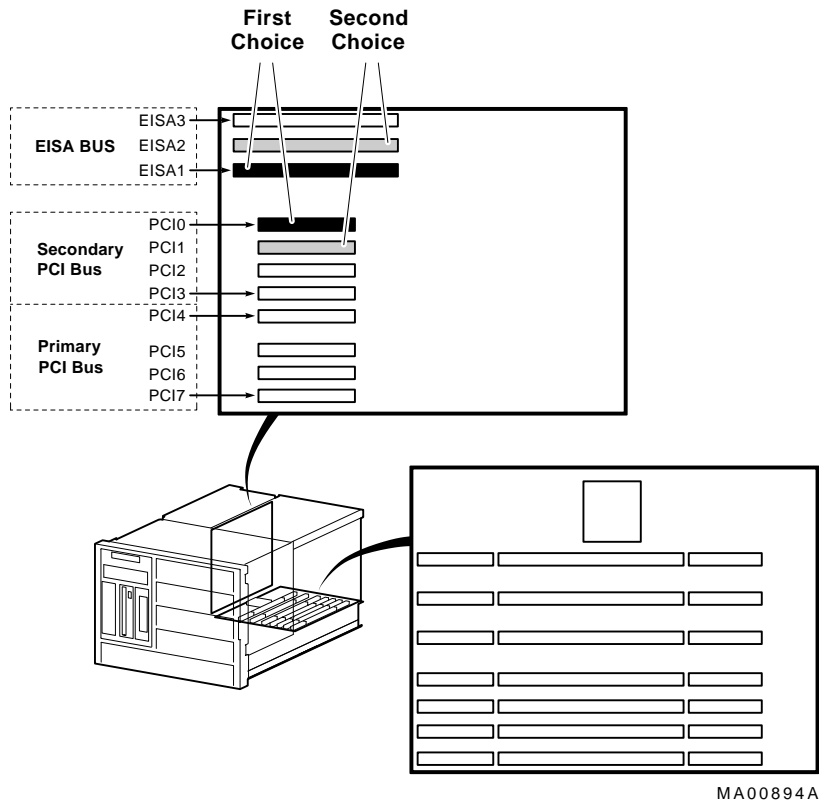

To install the CIPCA modules in the AlphaServer 2100A, perform the following steps:

1. Attach a PCI offset extender bracket (part number 74-47802-01) to the port module, if installing CIPCA-AA. Attach offset extender brackets to the port and link modules, if installing CIPCA-BA.
2. Locate the slots where the modules will be installed.

NOTE: PCI slots are shorter than EISA slots.

3. Follow these guidelines when installing CIPCA in an AlphaServer 2100A system:
 - Install the link module in an EISA slot, if CIPCA-AA, or install it in a PCI slot, if CIPCA-BA.
 - Install the port module in a PCI slot. PCI and EISA slots are labeled inside the unit.
4. Starting with either module, align the gold contacts on the module with the appropriate slot on the motherboard and press the module firmly into place.
5. Screw the bracket into the backplane frame to secure the modules in place.
6. Proceed to Section 2.4.5.

CAUTION: If your AlphaServer 2100A system has a PB2GA-FB (ATI MACH 64) graphics controller and/or a DEFPA FDDI controller installed, the pci_parity environment variable must be set to "off." Otherwise, the system may not operate properly. If necessary, set this variable from the SRM console as follows:

```
P00>>> set pci_parity off
```

2.4.4.5 Installing CIPCA in AlphaServer 2000 Systems

An AlphaServer 2000 motherboard has three PCI slots and seven EISA slots. Table 2-11 and Figure 2-11 show the recommended slot locations for installing CIPCA-AA in AlphaServer 2000 systems.

NOTE: The CIPCA-BA modules can be installed in any two adjacent PCI slots on AlphaServer 2000 systems.

Table 2-11 CIPCA-AA in AlphaServer 2000

Preferred Location	Port Module	Link Module
First Choice	PCI Slot 0	EISA Slot 1
Second Choice	PCI Slot 1	EISA Slot 2

Figure 2-11 CIPCA-AA in AlphaServer 2000

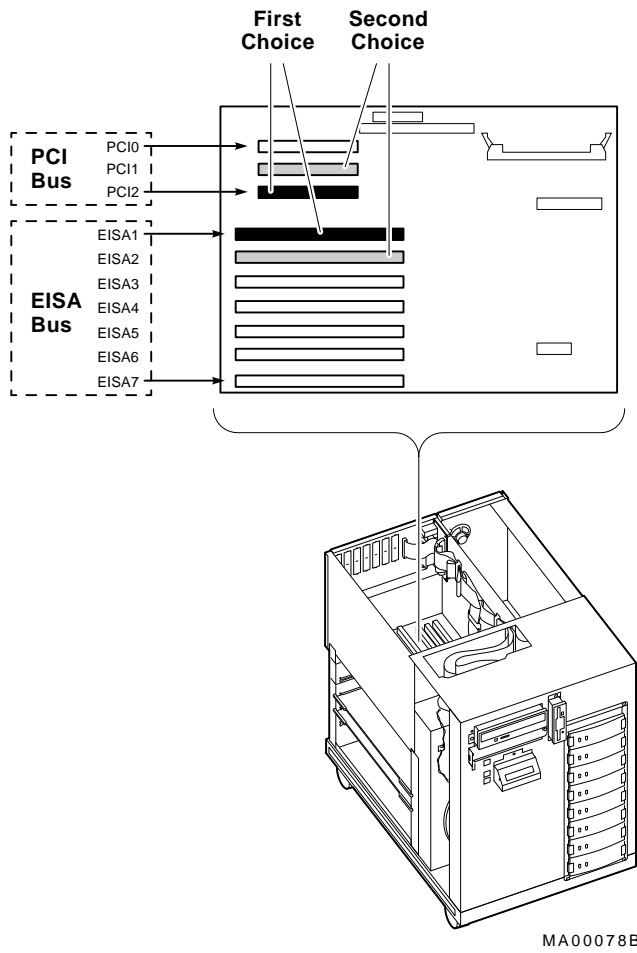

To install the CIPCA modules in the AlphaServer 2000, perform the following steps:

1. Attach a PCI straight extender bracket (part number 74-49920-02) to the port module, if installing CIPCA-AA. Attach straight extender brackets to the port and link modules, if installing CIPCA-BA.
2. Locate the slots where the modules will be installed.

NOTE: PCI slots are shorter than EISA slots.

3. Follow these guidelines when installing CIPCA-AA in an AlphaServer 2000 system:
 - Install the link module in an EISA slot, if CIPCA-AA, or install it in a PCI slot, if CIPCA-BA.
 - Install the port module in a PCI slot. PCI and EISA slots are labeled inside the unit.
4. Starting with either module, align the gold contacts on the module with the appropriate slot on the motherboard and press the module firmly into place.
5. Screw the bracket into the backplane frame to secure the modules in place.
6. Proceed to Section 2.4.5.

2.4.5 Connect the Intermodule Ribbon Cables

Connect the intermodule 60-pin ribbon cables to the port and link modules, as shown in Figure 2-12. The cables are keyed and are identical.

Figure 2-12 Ribbon Cable Connections

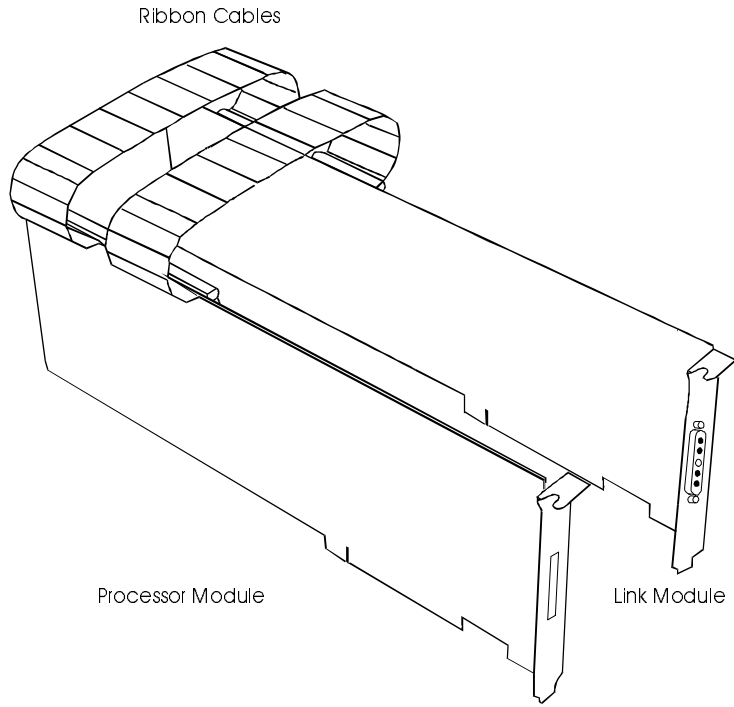

2.4.6 Connect the External Cables

1. Connect the CI transition cable to the external connector on the retaining bracket of the CIPCA link module. See Figure 2-13.
2. Connect the BNCIA cable set from the CI end of the connector (4 BNCIA cable receptacles) to the star coupler.

Figure 2-13 CI Transition Cable Connection to Link Module

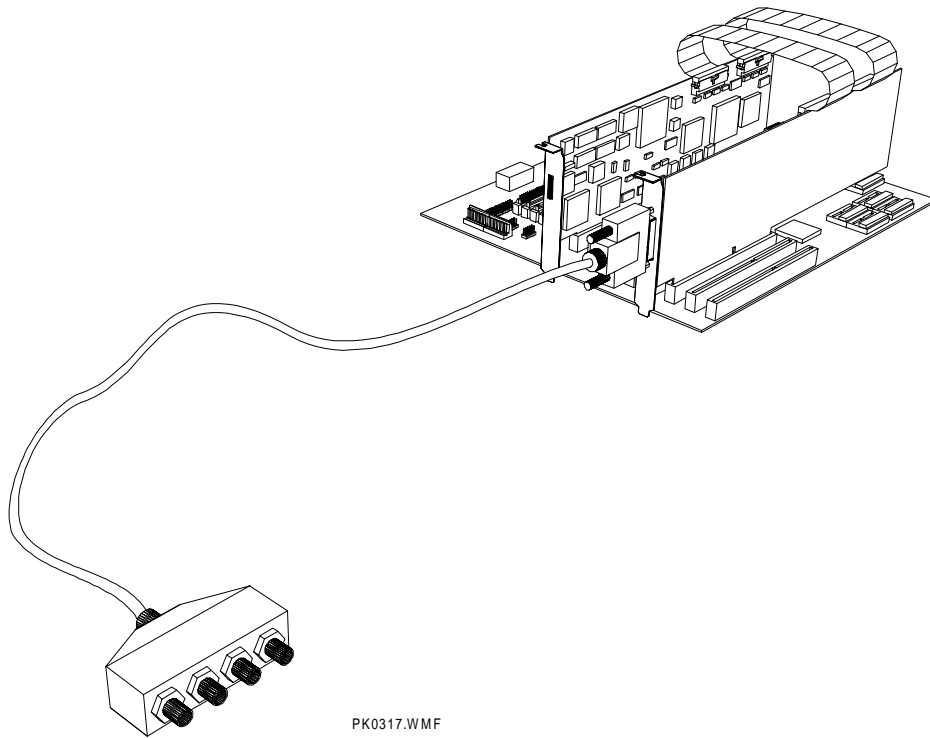

2.4.7 Close the System Unit and Reconnect Power Cord

Replace the panels and doors on the system unit. Reconnect all power cords. Refer to your system documentation for details.

2.4.8 Power on the System and Peripherals

Power on the system and peripherals. System output from the power-up self-test to the console differs depending on the system.

Chapter 3

Using CIPCA

3.1 In This Chapter

This chapter describes the operation of the CIPCA adapter. Sections in this chapter include:

- AlphaServer 8200/8400 Systems
- AlphaServer 4000/4100 Systems
- AlphaServer 2100/2100A Systems
- AlphaServer 2000 Systems
- Booting Disks Using CIPCA

3.2 AlphaServer 8200/8400 Systems

After system initialization, you can verify the presence of a CIPCA module in the AlphaServer 8200/8400 by observing the power-up display. The display indicates that the device is recognized by the system console, as shown in Example 3-1. To determine whether the device has passed its self-test, observe the LEDs on the CIPCA port module. Table 5-1 explains the CIPCA initialization LED codes.

After the system has powered up to the console, further verify the installation using the **show config** and **show device** commands.

- The **show config** command displays the system buses and devices on each bus.
- The **show device** command displays the controllers and associated drives.

3.2.1 Power-Up Display

Example 3-1 shows a typical 8200/8400 power-up display. In the example, I/O channel C12 is labeled as the PCI bus. The plus signs (+) mean only that the module indicated is recognized by the system. In this example, the CIPCA is at PCI node 3. To verify it as a CIPCA module, use the **show device** and **show config** console commands described in the sections that follow.

Example 3-1 AlphaServer 8200/8400 Power-Up Display

```
F E D C B A 9 8 7 6 5 4 3 2 1 0 NODE #
. . . A . . . M P TYP
. . . o . . . + ++ ST1
. . . . . . . EB BPD
. . . o . . . + ++ ST2
. . . . . . . EB BPD
. . . + . . . + ++ ST3
. . . . . . . EB BPD

      + . + . + . . . + . + . C12 PCI + ❶
. . . . . . . . . . . . . . C13
. . . . . . . . . . . . . . C14
. . . . . . . . . . . . . . C15

      . . . . . . A0 . ILV
      . . . . . . . 128 . 128MB
```

AlphaServer 8400 Console V4.1-6, SR0M V1.3, Nov 23, 1996

- ❶ Plus sign in slot 3 column indicates that the host system found a device installed in that location.

3.2.2 Show Config Command

Enter the **show config** command at the console prompt to verify the presence of the CIPCA device in the system configuration.

Example 3-2 shows a typical **show config** display for an AlphaServer 8200/8400 system. In the example, the console display indicates that the CIPCA adapter is installed in slot 3. Note that the two CIPCA modules are shown as one device installed in the port module slot. The plus sign shown next to the slot number indicates only that the system recognizes the device.

Example 3-2 AlphaServer 8200/8400 Show Config Display

	Name	Type	Rev	Mnemonic
TLSB				
0++	KN7CC-AB	8014	0000	kn7cc-ab0
1+	MS7CC	5000	0000	ms7cc0
5+	KFTHA	2000	0D02	kftha0
C12 PCI connected kftha0				pci0
1+	KZPAA	11000	0002	kzpaa0
3+	CIPCA	0601095	0001	cipca0 ❶
7+	KZPSA	81011	0000	kzpsa0
9+	KZPSA	81011	0000	kzpsa1
B+	DECchip 21140-AA	91011	0011	tulip0

- ❶ Indicates that the CIPCA module installed in slot 3 is on bus pci0 and has a default device name of cipca0. The module shown in the display is the port module in the PCI slot; the link module is not displayed.

3.2.3 Show Device Command

Enter the **show device** command to identify disk and tape devices connected to the CIPCA adapter. Example 3-3 shows a typical **show device** command output from an AlphaServer 8200/8400 system. CIPCA device information is shown in boldface.

To use the information provided by the **show device** command, you must be able to decode the device names shown in the output. See the “show device” command section in the system documentation for how to interpret these names.

Example 3-3 AlphaServer 8200/8400 Show Device Display

```
P00>>> show dev
polling for units on kzpaa0, slot 1, bus 0, hose12...
pka0.7.0.1.12      kzpaa0      SCSI   Bus Id   7
dka0.0.0.1.12      dka0        rrd44   1084
polling for units on cipca0, slot 3, bus 0, hose12...
cipca_a.0.0.3.12  dua      CI Bus ID 0
cipca_a.0.0.3.12 New node 4 HSJ004 HSJ  V25J HSJ4
dua600.4.0.3.12  HSJ004$DUA600      HSX0 ❶
dua610.4.0.3.12  HSJ004$DUA610      HSX0
dua620.4.0.3.12  HSJ004$DUA620      HSX0
dua630.4.0.3.12  HSJ004$DUA630      HSX0
dua640.4.0.3.12  HSJ004$DUA640      HSX0
dua650.4.0.3.12  HSJ004$DUA650      HSX0
dua660.4.0.3.12  HSJ004$DUA660      HSX0
polling for units on kzpsa0, slot 7, bus 0, hose12...
kzpsa0.7.0.7.12    dkb      Tpwr 1 Fast 1 Bus ID 7 F01 A09
dkb100.1.0.7.12    Dkb100      RZ26J 589S
dkb200.2.0.7.12    Dkb100      RZ26J 589S
dkb300.3.0.7.12    Dkb100      RZ28J 589S
dkb400.4.0.7.12    Dkb100      RZ28J 589S
dkb500.5.0.7.12    Dkb100      RZ28L 589R
dkb600.6.0.7.12    Dkb100      RZ28L 589R
polling for units on kzpsa1, slot 9, bus 0, hose12...
kzpsa1.7.0.9.12    dkc      Tpwr 1 Fast 1 Bus ID 7 F01 A09
dkc100.1.0.9.12    Dkb100      RZ28 442E
dkc200.2.0.9.12    Dkc200      RZ28 442E
dkc400.4.0.9.12    Dkc400      RZ28M 0568
dkc500.5.0.9.12    Dkc500      RZ28 442E
```

- ❶ Indicates the names for the HSJ disks in the CI cluster as dua6xx.4.0.3.12. Any one of these disks can be the system boot device.

3-4 CIPCA Adapter Installation and User's Guide

3.3 AlphaServer 4000/4100 Systems

After system initialization, you can verify the presence of a CIPCA module in the AlphaServer 4000/4100 by observing the power-up display. The display indicates that the device is recognized by the system console, as shown in Example 3-4. To determine whether the device has passed its self-test, observe the LEDs on the CIPCA port module. Table 5-1 explains the CIPCA initialization LED codes.

After the system has powered up to the console, further verify the installation using the **show config** and **show device** commands.

- The **show config** command displays the system buses and devices on each bus.
- The **show device** command displays the controllers and associated drives.

3.3.1 Power-Up Display

Example 3-4 shows a typical power-up display for AlphaServer 4000/4100. The power-up display indicates that the installed devices in the system are recognized. The CIPCA device is in bus 0 slot 3.

Example 3-4 Power-Up Display for AlphaServer 4000/4100

```
SROM V2.0 on cpu0
SROM V2.0 on cpu1
XSROM V3.0 on cpu1
XSROM V3.0 on cpu0
BCache testing complete on cpu1
BCache testing complete on cpu0
mem_pair0 - 128 MB
20..20..21..21..23..
please wait 3 seconds for T24 to complete
24..24..
Memory testing complete on cpu1
Memory testing complete on cpu0
starting console on CPU 0
sizing memory
  0    128 MB SYNC
starting console on CPU 1
probing IOD1 hose 1
  bus 0 slot 1 - NCR 53C810
probing IOD0 hose 0
  bus 0 slot 1 - PCEB
    probing EISA Bridge, bus 1
  bus 0 slot 2 - S3 Trio64/Trio32
  bus 0 slot 3 - CIPCA
  bus 0 slot 4 - DECchip 21040-AA
```

```
bus 0 slot 5 - NCR 53C810
probing IOD3 hose 3
probing IOD2 hose 2
  bus 0 slot 2 - PCI-PCI Bridge
    probing PCI-PCI Bridge, bus 2
      bus 2 slot 0 - ISP1020
configuring I/O adapters...
  ncr0, hose 1, bus 0, slot 1
  floppy0, hose 0, bus 1, slot 0
  tulip0, hose 0, bus 0, slot 3
  ncr1, hose 0, bus 0, slot 5
  isp0, hose 2, bus 2, slot 0
System temperature is 23 degrees C
AlphaServer 4000 Console V3.0-10, 19-NOV-1996 13:57:07
P00>>>
```

3.3.2 Show Config Command

Enter the **show config** command at the console prompt to verify the presence of the CIPCA device in the system configuration. The console display shows the system configuration, identifying all components.

CIPCA is identified as a device on the PCI bus. Note that the system does not see the CIPCA link module; it only draws power from the slot and is not configured as a device.

Example 3-5 shows a typical **show config** display for an AlphaServer 4000/4100 system. In the example, the console display indicates that CIPCA is installed in PCI0-5. Note that the adapter set is shown as one device installed in one slot.

Example 3-5 AlphaServer 4000/4100 Show Config Display

P00>>> show config

Digital Equipment Corporation
AlphaServer 4100

Console V4.8-3 OpenVMS PALcode V1.19-5, Digital UNIX PALcode V1.21-18

Module	Type	Rev	Name
System Motherboard	0	0000	mthrbrd0
Memory 64 MB EDO	0	0000	mem0
CPU (4MB Cache)	3	0000	cpu0
CPU (4MB Cache)	3	0000	cpu1
Bridge (IOD0/IOD1)	600	0032	iod0/iod1
PCI Motherboard	8	0002	saddle0
CPU (4MB Cache)	3	0000	cpu2
CPU (4MB Cache)	3	0000	cpu3

Bus 0 iod0 (PCI0)

Slot	Option Name	Type	Rev	Name
1+	PCEB	4828086	0005	pceb0
2+	S3 Trio64/Trio32	88115333	0000	vga0
3+	DECchip 21040-AA	21011	0024	tulip0
5+	CIPCA	6601095	0001	cipca0

Bus 1 pceb0 (EISA Bridge connected to iod0, slot 1)

Slot	Option Name	Type	Rev	Name
------	-------------	------	-----	------

Bus 0 iod1 (PCI1)

Slot	Option Name	Type	Rev	Name
1	NCR 53C810	11000	0002	ncr0
2	NCR 53C810	11000	0002	ncr1
4	DECchip 21040-AA	21011	0023	tulip0
5	DEC PCI MC	181011	008B	mc0

3.3.3 Show Device Command

Enter the **show device** or **show device cipca*** command to verify CIPCA connections in the AlphaServer 4000/4100 system. Refer to Example 3-6. The **show device cipca*** output lists each controller and its associated drives. CIPCA drives are shown as `dua*.*.*.*`.

Example 3-6 AlphaServer 4000/4100 Show Device Cipca* Display

```
P00>>> show device cipca*
polling cipca0 (CIPCA)slot 5, bus 0 PCI, hose 0 cixcd_poll_comp
cipca_a.7.0.5.0    dua      CI Bus ID 7
cipca_a.7.0.5.0    New node 4 HSJ004 Hsj V25J Hsj4
dua600.4.0.5.0     Hsj004$DUA600           HSX0 ❶
dua610.4.0.5.0     Hsj004$DUA610           HSX0
dua620.4.0.5.0     Hsj004$DUA620           HSX0
dua630.4.0.5.0     Hsj004$DUA630           HSX0
dua640.4.0.5.0     Hsj004$DUA640           HSX0
dua650.4.0.5.0     Hsj004$DUA650           HSX0
dua660.4.0.5.0     Hsj004$DUA660           HSX0
P00>>>
```

- ❶ Indicates the names for the Hsj disks in the CI cluster as `dua6xx.4.0.5.0`. Any one of these disks can be the system boot device.

3.4 AlphaServer 2100/2100A Systems

After system initialization, you can verify the presence of a CIPCA module in the AlphaServer 2100/2100A by observing the power-up display. The display indicates that the device is recognized by the system console, as shown in Example 3-7. To determine whether the device has passed its self-test, observe the LEDs on the CIPCA port module. Table 5-1 explains the CIPCA initialization LED codes.

After the system has powered up to the console, further verify the installation using the **show config** and **show device** commands.

- The **show config** command displays the system buses and devices on each bus.
- The **show device** command displays the controllers and associated drives.

3.4.1 Power-Up Display

Example 3-7 shows a typical AlphaServer 2100/2100A power-up display. The power-up display indicates that the installed devices in the system are recognized. The CIPCA device is in bus 0, slot 6.

Example 3-7 Power-Up Display for AlphaServer 2100

```
starting console on CPU 0
probing hose 0, PCI
probing PCI-to-EISA bridge, bus 1
bus 0, slot 0 -- ewa -- DECchip 21040-AA
bus 0, slot 1 -- pka -- NCR 53C810
bus 1, slot 1 -- vga -- Compaq Qvision
bus 1, slot 7 -- dra -- Mylex DAC960
bus 1, slot 8 -- pua -- KFESA
bus 0, slot 6 -- pub -- CIPCA
bus 0, slot 7 -- drb -- Mylex DAC960
bus 0, slot 8 -- ewb -- DECchip 21140-AA
starting console on CPU 1
starting console on CPU 2
starting console on CPU 3
Memory Testing and Configuration Status
```

3.4.2 Show Config Command

Enter the **show config** command at the console prompt to verify the presence of the CIPCA device in the system configuration. The console display shows the system configuration, identifying all components.

CIPCA is identified as a device on the PCI bus. Note that the system does not see the CIPCA link module; it only draws power from the slot and is not configured as a device.

Example 3-8 shows a typical **show config** display for an AlphaServer 2100 or 2100A system. In the example, the console display indicates that CIPCA is installed in slot 6. Note that the adapter set is shown as one device installed in one slot.

Example 3-8 AlphaServer 2100/2100A Show Config Display

```
Digital Equipment Corporation
AlphaServer 2100 5/250

SRM Console V4.4-0      VMS PALcode V1.15.4, OSF PALcode V1-18.3

Component      Status      Module ID
CPU 0          P          B2040-AB DECchip (tm) 21164-5
CPU 1          P          B2040-AA DECchip (tm) 21164-1
CPU 2          P          B2040-AA DECchip (tm) 21164-1
Memory 0       P          B2022-CA 512 MB
Memory 1       P          B2021-BA 64 MB
I/O
                B2110-AA
                dva0.0.0.0.1000.0      RX26

Slot  Option      Hose 0, Bus 0, PCI
0      DECchip 21040-AA  ewa0.0.0.0.0      08-00-2B-E2-91-04
1      NCR 53C810      pka0.7.0.1.0      SCSI Bus ID 7
                dka600.6.0.1.0      RRD45
                mka400.4.0.1.0      TZK11
                mka500.5.0.1.0      TLZ07
2      Intel 84676EB  Bridge to EISA
6      CIPCA          pua.8.0.6.0      CI Bus ID 8
                dua510.1.0.6.0      HSX0
                dua520.1.0.6.0      HSX0
                dua600.4.0.6.0      HSX0
                dua610.4.0.6.0      HSX0
                dua620.4.0.6.0      HSX0
                dua640.4.0.6.0      HSX0
                dua650.4.0.6.0      HSX0
                dua660.4.0.6.0      HSX0
7      Mylex DAC960    drb.0.0.7.0
```

3-10 CIPCA Adapter Installation and User's Guide

		drb0.0.0.7.0	1 Member JBOD
		drb1.0.0.7.0	2 Member RAID 1
		drb2.0.0.7.0	1 Member JBOD
		drb3.0.0.7.0	2 Member RAID
8	DECchip 21140-AA	ewb0.0.0.8.0	00-00-F8-00-11-50
Slot	Option	Hose 0, Bus 1, EISA	
1	Compaq Qvision		
7	Mylex DAC960	dra.0.0.1007.0	
		dra0.0.0.1007.0	2 Member RAID 1
		dra1.0.0.1007.0	2 Member RAID 0
		dra2.0.0.1007.0	1 Member JBOD
8	KFESA	pua0.7.0.1008.0	DSSI Bus ID 7
		dua10.0.0.1008.0	HSX0
		dua100.1.0.1008.0	HSX0
		dua110.1.0.1008.0	HSX0
		dua20.0.0.1008.0	HSX0
		dua200.1.0.1008.0	HSX0
		dua210.1.0.1008.0	HSX0
		dua30.0.0.1008.0	HSX0
		dua300.1.0.1008.0	HSX0
		dua310.1.0.1008.0	HSX0
		dua320.1.0.1008.0	HSX0
		dua40.0.0.1008.0	HSX0
		dua50.0.0.1008.0	HSX0

3.4.3 Show Device Command

Enter the **show device** command to verify CIPCA connections in the AlphaServer 2100 and 2100A systems. Example 3-9 shows the typical **show device** output from an AlphaServer 2100 system. Output from the 2100A is similar. The **show dev** output lists each controller and its associated drives. In the example, CIPCA information is shown in boldface. CIPCA drives are shown as **dua*.*.*.**** ❶ and the CIPCA adapter information is identified as **CIPCA** ❷.

Note that in the **show device** command output, CIPCA is indicated by the OpenVMS device name conventions documented in the *AlphaServer 2100 Owner's Guide*. If necessary, see documentation for details.

Example 3-9 AlphaServer 2100 Show Device Display

```

P00>>> show dev
dka600.6.0.1.0 DKA600                                RRD45    1645
dra0.0.0.1007.0  DRA0                               2 Member RAID 1
dra1.0.0.1007.0  DRA1                               2 Member RAID 0
dra2.0.0.1007.0  DRA2                               1 Member JBOD
drb0.0.0.1007.0  DRB0                               1 Member JBOD
drb1.0.0.1007.0  DRB1                               2 Member RAID 1
drb2.0.0.1007.0  DRB2                               1 Member JBOD
drb3.0.0.1007.0  DRB2                               2 Member RAID 0
dua10.0.0.1008.0 $1$DUA10 (HSD10)                               HSX0
dua100.0.0.1008.0 $1$DUA100(HSD30A)                             HSX0
dua110.0.0.1008.0 $1$DUA110(HSD30A)                             HSX0
dua20.0.0.1008.0  $1$DUA20 (HSD10)                               HSX0
dua200.0.0.1008.0 $1$DUA200(HSD30A)                             HSX0
dua210.0.0.1008.0 $1$DUA210(HSD30A)                             HSX0
dua30.0.0.1008.0  $1$DUA30 (HSD10)                               HSX0
dua300.0.0.1008.0 $1$DUA300(HSD30A)                             HSX0
dua310.0.0.1008.0 $1$DUA310(HSD30A)                             HSX0
dua320.0.0.1008.0 $1$DUA320(HSD30A)                             HSX0
dua40.0.0.1008.0  $1$DUA40 (HSD10)                               HSX0
dua50.0.0.1008.0  $1$DUA50 (HSD10)                               HSX0
dua510.1.0.6.0    $1$DUA510(HSJ001)                             HSX0
dua520.1.0.6.0    $1$DUA520(HSJ001)                             HSX0
dua600.1.0.6.0    $1$DUA600(HSJ001)                             HSX0 ❶
dua610.1.0.6.0    $1$DUA610(HSJ001)                             HSX0
dua620.1.0.6.0    $1$DUA620(HSJ001)                             HSX0
dua630.1.0.6.0    $1$DUA630(HSJ001)                             HSX0
dua640.1.0.6.0    $1$DUA640(HSJ001)                             HSX0
dua650.1.0.6.0    $1$DUA650(HSJ001)                             HSX0
dua660.1.0.6.0    $1$DUA660(HSJ001)                             HSX0
dva0.0.0.1000.0  DVA0                               RX26
mka500.4.0.1.0  MKA400                               RX26
CIPCA hose 0 slot 6 ❷
ewa0.0.0.0.0     EWA0                               08-00-2B-E2-91-04
ewb0.0.0.8.0     EWBO                               00-00-F8-00-11-50
pka0.7.0.1.0     PKA0                               SCSI Bus ID 7
pua0.7.01008.0   PAA0                               DSSI Bus ID 7

```

3.5 AlphaServer 2000 Systems

After system initialization, you can verify the presence of a CIPCA module in the AlphaServer 2000 by observing the power-up display. The display indicates that the device is recognized by the system console, as shown in Example 3-10. To determine whether the device has passed its self-test, observe the LEDs on the CIPCA port module. Table 5-1 explains the CIPCA initialization LED codes.

After the system has powered up to the console, further verify the installation using the **show config** and **show device** commands.

- The **show config** command displays the system buses and devices on each bus.
- The **show device** command displays the controllers and associated drives.

3.5.1 Power-Up Display

Example 3-10 shows a typical AlphaServer 2000 power-up display. The power-up display indicates that the installed devices in the system are recognized. The CIPCA module is in bus 0, slot 8.

Example 3-10 Power-Up Display for AlphaServer 2000 Systems

```
VMS PALcode V1.15-4...., OSF PALcode V1.18-3
```

```
....starting console on CPU 0
initialized idle PCB
initializing semaphores
initializing heap
initial heap 1c0c0
memory low limit = 134000
heap = 1c0c0, 13fc0
initializing driver structures
initializing idle process PID
XDELTA not enabled
initializing file system
initializing timer data structures
lowering IPL
CPU 0 speed is 4.00 ns (250MHz)
access NVRAM
entering idle loop
Starting Memory Diagnostics
SIMM memory module installed in slot 0
Testing CSIC on Memory Module 0
Testing all memory banks in parallel
Testing Memory bank 0
Testing Memory bank 1
```

3-14 CIPCA Adapter Installation and User's Guide

```

Configuring Memory Modules
Configured memory size = 4000000
Memory Diagnostics completed
probing hose 0, PCI
bus 0, slot 1 -- pka -- NCR 53C810
bus 0, slot 7 -- ewa -- DECchip 21040-AA
bus 0, slot 8 -- pua -- CIPCA
probing hose 1, EISA
bus 0, slot 7 -- vga -- ISA VGA
initializing keyboard
starting console on CPU 1
initialized idle PCB
initializing idle process PID
lowering IPL
CPU 1 speed is 4.00 ns (250MHz)
Memory Testing and Configuration Status
Module   Size   Base Addr   Intlv Mode   Intlv Unit   Status
-----
0        64MB   00000000    1-Way        0            Passed
Total Bad Pages 0
Testing the System
Testing the Disks (read only)
Testing the Network
AlphaServer 2000 Console V4.4-7, built on Nov 29 1996 at 21:43:46

```

3.5.2 Show Config Command

Enter the **show config** command at the console prompt to verify the presence of the CIPCA device in the system configuration. The console display shows the system configuration, identifying all components. In this example, CIPCA information is shown in boldface.

CIPCA is identified as a device on the PCI bus. Note that the system does not recognize the CIPCA link module; it only resides in the slot to draw power and is not configured as a device.

Example 3-11 shows a typical **show config** display for an AlphaServer 2000 system. In the example, the console display indicates that CIPCA is installed in slot 8. Note that the adapter set is shown as one device installed in one slot.

Example 3-11 AlphaServer 2000 Show Config Display

```
P00>>> show config

                               Digital Equipment Corporation
                               AlphaServer 2000 5/250

SRM Console V4.3-226           VMS PALcode V1.15-4, OSF PALcode V1.18-3

Component      Status      Module ID
CPU 0           P           B2040-AA DECchip (tm) 21164-1
CPU 1           P           B2040-AA DECchip (tm) 21164-1
Memory 0       P           B2023-BA 64 MB
I/O            B2111-AA
                dva0.0.0.0.1           RX26

Slot  Option      Hose 0, Bus 0, PCI
 1  NCR 53C810    pka0.7.0.1.0       SCSI Bus ID 7
                dka100.1.0.1.0     RZ28
                dka600.6.0.1.0     RRD43
 2  Intel 82375EB Bridge to Hose 1,
                EISA
 7  DECchip 21040-AA ewa0.0.0.7.0       08-00-2B-E5-63-F7
 8  CIPCA
Slot  Option      Hose 1, EISA
 7  ISA VGA
```

3-16 CIPCA Adapter Installation and User's Guide

3.5.3 Show Device Command

Enter the **show device** or **show device cipca*** command to verify CIPCA connections in the AlphaServer 2000 system. Example 3-12 shows a portion of the typical **show device** output from an AlphaServer 2000 system. The **show device** output lists each controller and its associated drives. In the example, CIPCA information is shown in boldface. CIPCA drives are shown as **dua*.*.*.*** ❶ and the CIPCA adapter information is identified as **CIPCA** ❷.

Note that in the **show device** command output, CIPCA is indicated by the OpenVMS device name conventions documented in the *AlphaServer 2000 Owner's Guide*. If necessary, see documentation for details.

Example 3-12 AlphaServer 2000 Show Device Display

```
P00>>> show dev
.
.
.
dua600.1.0.6.0          $1$DUA600(HSJ001)          HSX0          ❶
dua610.1.0.6.0          $1$DUA610(HSJ001)          HSX0
dva0.0.0.1000.0        DVA0                      RX26
mka500.4.0.1.0         MKA400                    RX26
CIPCA hose 0 slot 6          ❷
ewa0.0.0.1003.0        EWA0                      08-00-2B-94-D4-BA
ewb0.0.0.2000.0        EWB0                      00-00-2B-E2-70-57
pka0.7.0.1.0           PKA0                      SCSI Bus ID 7
pua0.7.0.2001.0        PKB0                      SCSI Bus ID 7
```

3.6 Booting Disks Using CIPCA

This section describes how to boot disks connected to a CIPCA adapter in AlphaServer 8200/8400, 4000/4100, and 2000/2100/2100A systems. You may want to verify the environmental settings for the cluster, such as operating system, default boot device, and boot flags. Refer to the documentation for your system if necessary.

These systems use four boot methods. The following sections describe each method using CIPCA.

3.6.1 Displaying Boot Information

To view the boot configuration for your system, enter the **show boot*** command. Using the asterisk in the command line displays all the boot parameters. This command enables you to view the following settings in your boot file:

Parameter	Description
boot_device	Device specified for last boot (may or may not be successful)
boot_file	Boot file last used (for example, booting over network or firmware updates)
boot_osflags	Current osflag settings for root and boot mode (conversational/non-conversational)
boot_reset	Status of reset flag (on/off)
bootdef_dev	Default boot device
booted_dev	Device last booted
booted_file	File used in last successful boot
booted-osflags	Boot flags specified for last successful boot

3.6.2 Simple Boot

The simplest way to boot disks connected to CIPCA is to enter the **boot** command followed by the CIPCA device that was named in the **show config** console display. For example,

```
P00>>> boot dua600.3.0.3.12 -f1 0,0
```

3.6.3 Setting CIPCA as the Default Boot Device

You can set the CIPCA device as the default boot device by setting the CIPCA device name in the environment variable `bootdef_dev`. At the console prompt, enter **set bootdef_dev** followed by the CIPCA device name.

```
P00>>> set bootdef_dev dua600.3.0.3.12
P00>>> set boot_osflags 1,1
```

Once the `bootdef_dev` variable is changed, boot using CIPCA by entering **boot** (or simply **b**) at the console prompt.

```
P00>>> boot
```

3.6.4 Setting Multiple CIPCAs as Default Boot Devices in Multicontroller Systems

You can also set CIPCA as the default boot device in multicontroller systems to boot through the `set bootdef_dev` environment variable. This method is typically used to specify both paths to a single disk when dual-redundant HSJs are used for failover.

Set the default boot device as follows. At the console prompt, enter **set bootdef_dev** followed by the device name of each CIPCA disk in each of the RAID controllers you want to boot. Use commas as delimiters.

```
P00>>> set bootdef_dev dua600.3.0.3.12,dua600.4.0.3.12
P00>>> set boot_osflags 1,1
```

In line 1 in the example above, the boot device is a disk (or RAID set) named dua600. This disk is connected to a dual-redundant HSJ (or HSC) controller that uses CI node addresses 3 and 4. The CIPCA used is in PCI slot 3 on hose 12. When booting, console code first tries accessing the dua600 via the HSJ at CI node 3; if that fails, then console code tries using the path through the HSJ at CI node 4.

In line 2 of the example above, the root (directory on the system disk that contains the OpenVMS files) is set to one, followed by the boot mode variable, which in the above example is set to conversational bootstrap mode. Booting conversationally enables you to view or change SYSGEN parameters in SYSBOOT during the boot procedure. See the Owner's Guide for your system for further details.

Once the bootdef_dev variable is set to include the CIPCA device names, boot via CIPCA by entering **boot** (or **b**) at the console prompt.

```
P00>>> boot
```

3.6.5 Setting CIPCA to Boot Automatically in Single or Multicontroller Systems

To set the CIPCA device to autoboot, set the auto_action environment variable to either **boot** or **restart**. Boot causes the system to boot automatically when it is turned on. Restart causes the system to boot automatically when the system is turned on or after it fails. Using **auto_action**, the system boots from the CIPCA adapter specified in the bootdef_dev variable and with defined boot_osflags.

```
P00>>> set auto_action [boot or restart]
```

Autoboot initiates the boot process automatically following the power-up procedure.

3.6.6 Bootstrap Procedure Output

Using any of the boot methods above, the system displays output similar to the examples that follow.

Example 3-13 AlphaServer 8200/8400 Boot Output

```
P00>>> b dka600 -fl 0,0
/boot dua600.4.0.3.12 -flags 0)
SRM boot identifier: mscp 18 10 0 11 1 ef00 6601095 DU 00000000F4BD
HSC011
boot adapter: cipca0 rev 1 in bus slot xx off of kftha0 in <bus id>
<slot #>
building FRU table.....
block 0 of dua600.4.0.3.12 is a valid boot block
reading 1089 blocks from dua600.4.0.3.12
bootstrap code read in
base = 200000, image_start = 0, image_bytes = 88200
initializing HWRBP at 2000
initializing page table at 1f2000
initializing machine state
setting affinity to the primary CPU
jumping to bootstrap code

OpenVMS (TM) Alpha Operating System, Version V6.2-1H3
```

Example 3-14 AlphaServer 4000/4100 Boot Output

```
P00>>> boot
/boot dua640.4.0.5.0 -flags 0)
Building FRU table
block 0 of dua640.4.0.5.0 is a valid boot block
reading 1002 blocks from dua640.4.0.5.0
bootstrap code read in
base = 200000, image_start = 0, image_bytes = 7d400
initializing HWRPB at 2000
initializing page table at 1f2000
initializing machine state
setting affinity to the primary CPU
jumping to bootstrap code
.
.
.
OpenVMS (TM) Alpha Operating System, Version 6.2-1H3

$
```

Example 3-15 AlphaServer 2100 and 2000 Boot Output

```
P00>>> b dka600 -fl 0,0
/boot dua600.4.0.6.0)
block 0 of dua600.4.0.6.0 is a valid boot block
reading 1089 blocks from dua600.4.0.6.0
bootstrap code read in
base = 200000, image_start = 0, image_bytes = 88200
initializing HWRBP at 2000
initializing page table at 1f2000
initializing machine state
setting affinity to the primary CPU
jumping to bootstrap code
OpenVMS (TM) Alpha Operating System, Version V6.2-1H3
.
.
.
```

Chapter 4

Updating Firmware

4.1 In This Chapter

This chapter describes how to update CIPCA and console firmware for AlphaServer systems. The Loadable Firmware Update (LFU) utility is used to update console firmware and any devices installed in the system. This chapter covers the following topics:

- Firmware Updates
- Update Procedure Overview
- Updating CIPCA Firmware
- Updating Console Firmware

4.2 Firmware Updates

Firmware updates are available either on Digital's Alpha Systems Firmware Update CD-ROM or through the Internet:

- Using ftp, open a connection to ftp.digital.com, then go to

`/pub/Digital/Alpha/firmware/`

- Using a World Wide Web browser, use the following URL:

`http://ftp.digital.com/pub/Digital/Alpha/firmware/`

The readme.html or readme.txt file explains how to download and use the firmware files. New firmware released between shipments of the CD-ROM are available in an interim directory: `/pub/Digital/Alpha/firmware/interim/`.

NOTE: The firmware update procedures described in the following sections apply to V3.8 of the AlphaServer Systems Firmware Update CD-ROM. For later versions of the CD-ROM, the procedure may change. Please read the readme.html or readme.txt file on the CD-ROM, as well as the particular system's console firmware release notes, before beginning a firmware update.

Table 4–1 shows the minimum required firmware versions for the CIPCA adapter and supported AlphaServer systems. If your system firmware is below the minimum revision level, you will need to update the firmware in order to operate the CIPCA adapter.

Table 4–1 Minimum Firmware Revisions for CIPCA and AlphaServer Systems

AlphaServer System	Console Firmware Minimum Revision	CIPCA Firmware Minimum Revision
8200/8400	V3.0	A111
4000	V3.0	A214
4100	V1.2-4	A214
2000/2100/2100A	V4.4	A111

NOTE: Consult the firmware release notes and the release notes for your system to make sure that your firmware is compatible with the required operating system revision and hardware revision levels.

4.3 Firmware Update Procedure Overview

The procedure outlined below is an overview of the firmware update procedure. Firmware updates are performed using the loadable firmware update utility (LFU). Examples for the various AlphaServer models are shown in the sections that follow.

*NOTE: To use the loadable firmware update utility on AlphaServer 4000/4100 systems, type **lfu** at the SRM console prompt and follow the prompts.*

- ❶ After the system initializes, enter the **boot** command and the boot device name at the console prompt. The system README file is displayed, and then the name of the default firmware update file is displayed.
- ❷ At the **bootfile:** prompt, press Return to use the default bootfile.
- ❸ On AlphaServer 2x00 systems, enter the operating system OS_TYPE, OpenVMS when prompted. The update utility loads and displays its command options.

NOTE: This step is not required on AlphaServer 4000/4100 and AlphaServer 8200/8400 systems.

- ❹ The update prompt is displayed.
- ❺ Enter **list** to verify that you are loading the correct revision of the firmware and to list the devices in the system.
- ❻ At this point in the procedure, you can update a specific device shown in the **list** command output or update all devices in the system.
 - To update all the devices in the system, including the CIPCA firmware and the system console firmware, enter **update**.
 - To update a specific device, enter **update device_name**, where *device_name* is the specific device you want to update, as shown in the **list** command output.
- ❼ Enter **y** to proceed with the firmware update.
- ❽ Enter **n** when the system queries if you want to perform a manual update.

NOTE: This prompt does not appear when updating AlphaServer 8200/8400 systems or AlphaServer 4000/4100 systems.

- ❾ Enter **exit** to exit the firmware update utility. This step is not required on some systems.
- ❿ Reset the system as appropriate. See the section documenting your AlphaServer system for details.

4.3.1 LFU Filenames

The loadable firmware update utility (LFU) file varies for each AlphaServer system. Table 4–2 specifies the LFU bootfile name required for each model of AlphaServer system. It is only necessary to enter the bootfile name if you are updating the firmware from media other than the AlphaServer Systems Firmware Update CD-ROM. For example, you need to enter the bootfile name if you download the firmware files from the Internet.

*NOTE: It is not necessary to specify an LFU bootfile for the AlphaServer 4100/4100 system, even if you are booting from media other than the Firmware Update CD-ROM. Enter the **LFU** command from the console prompt and specify the firmware load device, as described in Section 4.4.2.*

Table 4–2 LFU Filenames for AlphaServer Systems

AlphaServer Model	LFU Bootfile Required
AlphaServer 8200/8400	[alpha8x00]as8000_v09.exe
AlphaServer 4000/4100	See <i>NOTE</i> above.
AlphaServer 2100A 5/xxx	[alpha2100]as2100a_e5_v4_7.exe
AlphaServer 2100A 4/xxx	[alpha2100]as2100a_e4_v4_7.exe
AlphaServer 2000/2100 5/xxx	[alpha2100]as2100_e5_v4_7.exe
AlphaServer 2000/2100 4/xxx	[alpha2100]as2100_e4_v4_7.exe

4.4 Firmware Update Examples

Examples of firmware updates from the distribution CD-ROM are covered in this section. The callouts in the examples correspond to the steps in the overview procedure found in Section 4.3.

4.4.1 Updating AlphaServer 8200/8400 Firmware

If your system is not running the firmware revision listed in Table 4–1 or higher, you need to update AlphaServer 8200/8400 console firmware in order to use the CIPCA adapter. Example 4-1 illustrates the update procedure on an 8200/8400 system. The LFU is booted from the local SCSI CD-ROM drive using the Alpha Systems Firmware Update CD-ROM.

NOTE: Set `auto_action` to `halt` before running LFU. Afterward, you may restore it to its normal desired value.

User input is shown in boldface. In this example, it is assumed that you have already initialized the system and determined the name of the CD-ROM drive.

Example 4-1 Typical Firmware Update Procedure for AlphaServer 8200/8400 Systems

```
P00>>> b dkd0 ❶
(boot dkd0.0.0.5.0 -flags 0)
SRM boot identifier: scsi 0 5 0 0 0 ef00 10201077
boot adapter: isp3 rev 1 in bus slot 5 off of kftia0 in TLSB slot 8
Building FRU table.....
block 0 of dkd0.0.0.5.0 is a valid boot block
reading 1150 blocks from dkd0.0.0.5.0
bootstrap code read in
base = 200000, image_start = 0, image_bytes = 8fc00
initializing HWRPB at 2000
initializing page table at 1f2000
initializing machine state
setting affinity to the primary CPU
jumping to bootstrap code
```

```

+++++ 15-Nov-96
+   AlphaServer 8200/8400 Firmware   +
+           README-First !!!         +
+++++

```

1. Latest Firmware Update Revisions

The latest Firmware Update Bootfile "AS8000_V09.EXE" on the Alpha Firmware CD V3.8, contains the SRM Console V4.1, which has the following components (* = CHANGED since last release) :

```

SROM V3.1
VMS PALcode V1.19-2 *
UNIX PALcode V1.21-3 *
ISO1020 FW V2.10
AlphaBIOS 5.14 (Proto 3)

```

The update bootfile also contains the following I/O Option Firmware Revisions (* = CHANGED since last release) :

Option Name	Hardware Rev	Firmware Rev
-----	-----	-----

Hit <RETURN> to scroll text, or <CTRL/C> to skip text.

CIPCA	All revs	A315 *
DEFAA	All revs	1.10 *
DEFPA	All revs	2.46
DEMFA	All revs	2.1

.
.
.

Hit <RETURN> to scroll text, or <CTRL/C> to skip text.

The default bootfile for this platform is

[ALPHA8X00]AS8000_V09.EXE

Hit <RETURN> at the prompt to use the default bootfile.

Bootfile:



Starting Firmware Update Utility

Unpacking firmware files

readme adr = 1000020 len = 800(2048)

4-6 CIPCA Adapter Installation and User's Guide

```

kn7cc_fw      adr = 1000a40 len = 141000(1314816)
arcrom        adr = 1141c60 len = 60000(393216)
cipca_fw      adr = 11a1e80 len = ce00(52736)
defaa_fw      adr = 11db2c0 len = 78c00(494592)
demfa_fw      adr = 12540e0 len = 3de00(253440)

```

```

.
.
.

```

***** Loadable Firmware Update Utility *****

```

-----
Function      Description
-----
Display       Displays the system's configuration table.
Exit          Done exit LFU (reset).
List          Lists the device, revision, firmware name, and update
              revision.
Modify        Modifies port parameters and device attributes.
Update        Replaces current firmware with loadable data image.
Verify        Compares loadable and hardware images.
? or Help     Scrolls this function table.
-----

```

UPD> list

45

Device	Current Revision	Filename	Update Revision
cipca0	A214	cipca_fw	A315
demna0	8.3	demna_fw	8.3
kn7cc-ab0	3.0	kn7cc_fw	3.0
kzmsa0	5.6	kzmsa_fw	5.6
pfi0	2.46	dfpaa_fw	2.46
xct0	129	xct_fw	Missing file
		defaa_fw	1.0
		demfa_fw	2.0
		kcm44_fw	3.1
		kdm70_fw	4.4
		kfmsb_fw	2.4
		kzpsa_fw	A09

UPD> update

6

Confirm update on:

cipca0
demna0
kn7cc-ab0
kzmsa0
pfi0
xct0
[Y/(N)]y

7

WARNING: updates may take several minutes to complete for each device.

DO NOT ABORT!

cipca0 Updating to A315... Verifying A315... PASSED.

UPD> exit

9

Initializing...

F	E	D	C	B	A	9	8	7	6	5	4	3	2	1	0	NODE #
							A	.	.	.	A	.	M	P	.	TYP
							O	.	.	.	O	.	+	++	.	ST1
							EB	.	BPD
							O	.	.	.	O	.	+	++	.	ST2
							EB	.	BPD
							+	.	.	.	+	.	+	++	.	ST3
							EB	.	BPD
								.	+	+	+	+	+	+	+	C0 PCI +
.	C1
.	C16
		+	.	.	.	+	+	.	.	.	+	+	.	.	.	C17 XMI +
				.	+	+	C18 PCI +
.	C19
							A0	.	ILV
							256	.	.	256MB

AlphaServer Console V4.1-6, 15-NOV-1996 10:47:57, SROM V3.1

4.4.2 Updating AlphaServer 4000/4100 Firmware

If your system is not running the firmware revision listed in Table 4–1 or higher, you will need to update the console firmware in order to use the CIPCA adapter. This section describes how to run the update utility from the Alpha Systems Firmware Update CD-ROM. To load the update firmware from other devices, see the AlphaServer 4000/4100 user documentation.

Example 4-2 illustrates the update procedure. The example assumes you have loaded the Firmware Update CD-ROM. User input is shown in boldface. The callouts in the procedure correspond to steps 5, 6, 7, and 9 in the overview procedure in Section 4.3. As shown in the example, you enter **lfu** at the SRM console prompt, then enter the name of the firmware load device when prompted. At the next prompt, press Return to use the default firmware file name.

Example 4-2 Typical Firmware Update Procedure for AlphaServer 4000/4100

```
P00>>> lfu

      ***** Loadable Firmware Update Utility *****

Select firmware load device (cda0, dva0, ewa0), or
Press <return> to bypass loading and proceed to LFU: cda0

Please enter the name of the firmware files list, or
Press <return> to use the default filename [AS4X00FW]:

Copying AS4X00FW from DKA600.6.0.1.1
Copying [as4x00]RHREADME from DKA600.6.0.1.1.....
Copying [as4x00]RHSRMROM from DKA600.6.0.1.1.....
Copying [as4x00]RHARCROM from DKA600.6.0.1.1.....
Copying [options]CIPCA214 from DKA600.6.0.1.1.....
Copying [options]DFPAA246 from DKA600.6.0.1.1.....
Copying [options]KZPSAA10 from DKA600.6.0.1.1.....
```

Function	Description
Display	Displays the system's configuration table.
Exit	Done exit LFU (reset).
List	Lists the device, revision, firmware name, and update revision.
Lfu	Restarts LFU.
Readme	Lists important release information.
Update	Replaces current firmware with loadable data image.
Verify	Compares loadable and hardware images.
? or Help	Scrolls this function table.

```

UPD> list 4, 5

Device          Current Revision  Filename          Update Revision
AlphaBIOS       V5.21-1          arcrom            V5.24-0
cipca0          A214             cipca_fw          A315
kzpsa0          A09              kzpsa_fw          A10
srmflash        V2.0-3           srmrom            V3.0-5

UPD> update 6
WARNING: updates may take several minutes to complete for each device.

Confirm update on: AlphaBIOS      [Y/(N)] y 7

                DO NOT ABORT!
AlphaBIOS      Updating to V5.24-0    Verifying V5.24-0    PASSED.

Confirm update on: cipca0          [Y/(N)] y

                DO NOT ABORT!
cipca0         Updating to  A315      Verifying A315      PASSED.

Confirm update on: kzpsa0          [Y/(N)] y

                DO NOT ABORT!
kzpsa0         Updating to  A10       Verifying A10       PASSED.

Confirm update on: srmflash        [Y/(N)] y

                DO NOT ABORT!
srmflash       Updating to V3.0-5    Verifying V3.0-5    PASSED.

UPD> exit 9

```

4-10 CIPCA Adapter Installation and User's Guide

4.4.3 Updating AlphaServer 2000/2100/2100A Firmware

If your system is not running the firmware revision listed in Table 4–1 or higher, you will need to update the console firmware in order to use the CIPCA adapter. The update utility is booted from the CD in drive dka600. Example 4-3 illustrates the update procedure on a 2100 system. The procedure is the same on other AlphaServer 2x00 systems. User input is shown in boldface. The callouts in the procedure correspond to the steps in the overview procedure in Section 4.3.

Example 4-3 Typical Firmware Update Procedure for AlphaServer 2100 System

```
P00>>> b dka600
(boot dka600.6.0.1.0 -flags 0, a0)
block 0 of dka600.6.0.1.0 is a valid boot block
reading 1150 blocks from dka600.6.0.1.0
bootstrap code read in
base = 200000, image_start = 0, image_bytes = 8fc00
initializing HWRPB at 2000
initializing page table at 5ff0000
initializing machine state
setting affinity to the primary CPU
jumping to bootstrap code
```

❶

```

+++++ 15-Nov-96
+   AlphaServer 2000/2100/2100A Firmware  +
+           README-First !!!             +
+++++

```

1. Latest Firmware Update Revisions

The latest Firmware Update Bootfiles located in the V3.8 CD directory [ALPHA2100] on the ISO9660 file structure, are the following :

Model	Bootfile
-----	-----
AlphaServer 2000/2100 4/xxx	AS2100_E4_V4_7.EXE
AlphaServer 2000/2100 5/xxx	AS2100_E5_V4_7.EXE
AlphaServer 2100A 4/xxx	AS2100A_E4_V4_7.EXE
AlphaServer 2100A 5/xxx	AS2100A_E5_V4_7.EXE

.
.
.

Hit <RETURN> to scroll text, or <CTRL/C> to skip text.
The default bootfile for this platform is

[ALPHA2100]AS2100_E5_V4_7.EXE

Hit <RETURN> at the prompt to use the default bootfile.

Bootfile:

2

```

VMS PALcode V1.19-2, OSF PALcode V1.21-1
starting console on CPU 0
initialized idle PCB
initializing semaphores
initializing heap
initial heap 1c0c0
memory low limit = 200000
heap = 1c0c0, 13fc0
initializing driver structures
initializing idle process PID
XDELTA not enabled
initializing file system
initializing timer data structures
lowering IPL
CPU 0 speed is 4.00 ns (250MHz)
access NVRAM
entering idle loop

```

4-12 CIPCA Adapter Installation and User's Guide

```
Starting Memory Diagnostics
Memory Diagnostics completed
probing hose 0, PCI
probing PCI-to-EISA bridge, bus 1
probing PCI-to-PCI bridge, bus 2
bus 0, slot 0 -- ewa -- DECchip 21040-AA
bus 0, slot 1 -- pka -- NCR 53C810
bus 1, slot 3 -- fra -- DEFEA
bus 1, slot 8 -- vga -- Compaq Qvision
bus 0, slot 6 -- dra -- Mylex DAC960
bus 2, slot 0 -- ewb -- DECchip 21040-AA
bus 2, slot 1 -- pkb -- QLogic ISP1020
bus 0, slot 8 -- ewc -- DECchip 21140-AA
initializing keyboard
```

```
Checking dka600.6.0.1.0 for the option firmware files. . .
Copying DFEEA130 from dka600.6.0.1.0. . .
Copying DFEEB246 from dka600.6.0.1.0. . .
Copying DFXAA246 from dka600.6.0.1.0. . .
Copying KZPSAA10 from dka600.6.0.1.0. . .
Copying CIPCA315 from dka600.6.0.1.0. . .
```

```
Please enter your operating systems OS_TYPE:
[NT, UNIX, OpenVMS]: OpenVMS
```



***** Loadable Firmware Update Utility *****

Function	Description
Display	Displays the system's configuration table.
Exit	Done exit LFU (reset).
List	Lists the device, revision, firmware name, and update revision.
Readme	Lists important release information.
Update	Replaces current firmware with loadable data image.
Verify	Compares loadable and hardware images.
? or Help	Scrolls this function table.

```

UPD> list
Device      Current Revision  Filename      Update
Revision
arcflash    4.43-0           arcrom        4.51-1
pua0        A214             cipca_fw      A315
srmflash    4.3-226         srmrom        4.7-148
                dfeaa_fw      1.3
                dfeab_fw      2.46
                dfpaa_fw      2.46
                kzpsa_fw      A10

UPD> update
Confirm update on:
arcflash
pua0
srmflash
[Y/(N)]y
WARNING: updates may take several minutes to complete for each device.
                DO NOT ABORT!
arcflash      Updating to 4.51-1... Verifying 4.51-1... PASSED.
pua0          Updating to A315...   Verifying A315...   PASSED.
srmflash      Updating to 4.7-148... Verifying 4.7-148 PASSED.
UPD> exit
Do you want to do a manual update? [y/n] n
Please reset the system. . . . .

```

45

6

7

8

9

Press the reset button on the AlphaServer front panel.

Chapter 5

Troubleshooting

5.1 In This Chapter

This chapter contains basic troubleshooting procedures for determining problems and causes. Sections in this chapter include:

- Reading LEDs
- Advanced Troubleshooting

5.2 Reading LEDs

The LEDs are located on the adapter retaining bracket. indicates the location and position of the LEDs.

Figure 5-1 LEDs on Port Module Retaining Bracket

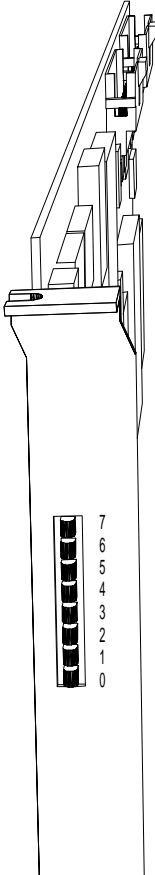

PK0318.WMF

5-2 CIPCA Adapter Installation and User's Guide

During initialization, normal operation, and in the event of an error, the CIPCA port module displays information on its bank of eight LEDs.

Table 5–1 shows the LED codes displayed during the initialization of the adapter. The codes will appear in the order presented in the table. After initialization, the LEDs will remain in the state described in the last row of the table.

Table 5–1 CIPCA Initialization Codes

Key:

- = Steady On
- ◐ = On or Off depending on CIPCA status
- * = Blinking

Amber	Green							Description	
	7	6	5	4	3	2	1		0
●	●	●	●	●	●	●	●	●	Adapter hardware has been reset. All LEDs on.
									Adapter has begun initialization and self-test.
●									Adapter is loading microcode from the on-board FLASH device.
	●								Adapter is in NPORT uninitialized state.
	●	●							Adapter is in NPORT disabled state.
	◐	◐	◐	◐	◐	◐	◐	*	Adapter is in NPORT enabled state. LED 0 blinks. LED 6 will be On if the cluster size is 32 and Off if the cluster size is 16. LEDs 5–1 will be set On or Off to form a bit pattern indicating the node number. LED 5 is the MSB and LED 1 is the LSB. The LEDs will remain in this state until the adapter is reinitialized or an error occurs.

If the CIPCA adapter encounters an error, it illuminates LED 7 (the amber LED) and displays an error code on the remaining LEDs. Table 5–2 shows the LED error codes.

Table 5–2 CIPCA Error Codes

Key:

- = Steady On
- ◐ = On or Off depending on CIPCA status
- * = Blinking

Amber	Green							Description	Fault Area
7	6	5	4	3	2	1	0		
●							●	Reserved	n/a
●						●		Microcode checksum in PROM invalid	Port module
●						●	●	Microprocessor SRAM test failed	Port module
●					●			Buffer SRAM test failed	Port module
●					●		●	Intermodule ribbon cables are swapped	Intermodule cable fault. Reinstall the cables.
●					●	●		Intermodule ribbon cable on connector A is bad or not installed correctly.	Intermodule cable fault. Reinstall the cables. To identify connectors A and B, see Note 2.
●					●	●	●	Intermodule ribbon cable on connector B is bad or not installed correctly.	Intermodule cable fault. Reinstall the cables. To identify connectors A and B, see Note 2.

(continued on next page)

Table 5-2 CIPCA Error Codes (cont.)

Key:

- = Steady On
- ◐ = On or Off depending on CIPCA status
- * = Blinking

Amber	Green							Description	Fault Area	
	7	6	5	4	3	2	1			0
●					●				Node address mismatch for intermodule ribbon cables	Check link module.
●					●			●	Cluster size mismatch for intermodule ribbon cables	Check link module.
●					●			●	Contents of Configuration PROM are invalid	Port module
●					●			●	Invalid Port Register access during Reset Initialization	See Note 1.
●				●					Invalid pointer passed to "free" routine	See Note 1.
●				●				●	Data structure to be "freed" still linked to a queue	See Note 1.
●				●				●	Internal inconsistency detected	See Note 1.
●				●				●	Reserved	n/a
●				●			●		Reserved	n/a
●				●			●	●	Port Register read interrupt found pending.	See Note 1.
●				●			●	●	Invalid Port Register access by the driver	See Note 1.
●				●			●	●	DQE_LEN/MQE_LEN in ABLK > IBUF_LEN	See Note 1.
●				●	●				SBZ fields in ABBR register not zero.	See Note 1.

(continued on next page)

Table 5-2 CIPCA Error Codes (cont.)

Amber	Green							Description	Fault Area
	7	6	5	4	3	2	1		
●			●	●				SBZ fields in ABBR register not zero.	See Note 1.
●			●	●			●	A driver to adapter queue entry was not recognized	See Note 1.
●			●	●			●	AMTECR was written while MTD in AMCSR is set	See Note 1.
●			●	●			●	Error status detected in PCI DMA Ring 0	See Note 1.
●		●		●			●	Reserved	n/a
●		●		●			●	Reserved	n/a
●			●	●	●			Error status detected in PCI DMA Ring 1	See Note 1.
●			●	●	●		●	The microprocessor or an ASIC detected a parity error	See Note 1.
●			●	●	●	●		Invalid retransmit dispatch index	See Note 1.
●			●	●	●	●	●	Parity error detected in Tx Ring status field	See Note 1.
●		●						Underrun detected in Tx Ring status field	See Note 1.
●		●					●	No Tx path available while VC was open	See Note 1.
●		●					●	Parity error detected in Rx Ring status field	See Note 1.

(continued on next page)

Table 5-2 CIPCA Error Codes (cont.)

Key:

- = Steady On
- ◐ = On or Off depending on CIPCA status
- * = Blinking

Amber	Green							Description	Fault Area	
	7	6	5	4	3	2	1			0
●			●				●	●	Error detected in CI ASIC 0 RX status register	See Note 1.
●			●			●			Error detected in CI ASIC 1 RX status register	See Note 1.
●			●			●		●	Error detected in CI ASIC 0 TX status register	See Note 1.
●			●			●	●		Error detected in CI ASIC 1 TX status register	See Note 1.
●			●			●	●	●	NRP1 buffer pointer was NULL	See Note 1.
●			●		●				CIPCA machine check	See Note 1.
●	●	●	●					●	DSE Error Code 1 -	See Note 1.
●	●	●	●					●	DSE Error Code 2 -	See Note 1.
●	●	●	●					●	DSE Error Code 3 -	See Note 1.
●	●	●	●			●			DSE Error Code 4 -	See Note 1.
●	●	●	●			●		●	DSE Error Code 5 -	See Note 1.

(continued on next page)

Table 5-2 CIPCA Error Codes (cont.)

Amber	Green							Description	Fault Area
	7	6	5	4	3	2	1		
●	●	●	●			●	●	DSE Error Code 6 -	See Note 1.
●	●	●	●			●	●	DSE Error Code 7 -	See Note 1.
●	●	●	●	●				DSE Error Code 8 -	See Note 1.
●	●	●	●	●			●	Memory system error (MSE)	See Note 1.
●	●	●	●	●			●	Sanity timer expiration (STE)	See Note 1.

Note 1: Other error codes do not point specifically at either module or intermodule ribbon cabling. Some of these error codes may indicate problems with the OpenVMS device driver or other non-CIPCA components.

Note 2: Link module connectors are identified by the etch near the ribbon cable connectors. See Figure 5–2.

Figure 5–2 Location of Path Identification Etch on Link Module

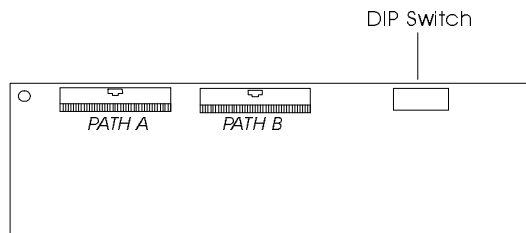

PK0319.W MF

5.3 Advanced Troubleshooting

This section is for Field Service personnel only. Field Service personnel should refer to Appendix C for sample DECEvent messages. The following commands can be used to invoke DECEvent to analyze dump files:

- **diagnose** - analyzes the current system log file
- **diagnose [filename]** - analyzes the error log file named “filename.sys.”

For further help, enter **help diagnose** at the OpenVMS prompt for more information about using the DECEvent utility.

5-8 CIPCA Adapter Installation and User’s Guide

Appendix A

Specifications

Specifications for the CIPCA adapter are as follows:

Table A-1 Environmental Characteristics

Operating	+10 to +40 degrees C (+50 to +104 degrees F)
	10% to 90% relative humidity
	Sea level to 2000 m (8000 ft)
Non-operating	-40 to +66 degrees C (-40 to +151 degrees F)
	8% to 95% relative humidity
	-300 m (-1000 ft) to 3600 m (12000 ft)

Table A-2 Electrical Characteristics

	Port Module (30-46980-02)	Link Module (30-46980-01)
Power Consumption (typical)	1.6 A at 5 V	2.0 A at 5 V

Appendix B

Registers

The CIPCA adapter uses three sets of registers. This appendix describes the register sets and their uses. The general categories of registers are as follows:

- **PCI Configuration Registers.** Configure CIPCA for operation on the PCI bus. Two I/O map registers and one memory map register are provided to communicate with CIPCA.
- **PCI ASIC Hard Registers.** Map to the host using either I/O or memory address maps.
- **Soft Registers.** Provide N-Port communication capability with the host. Soft registers are located in the SRAM on the port module. Accesses are tracked by the ASIC transaction flags.

B.1 PCI Configuration Registers

The PCI configuration space conforms to PCI specification 2.1. The configuration registers support byte, word, and longword (PCI doubleword) accesses. Write transactions to reserved fields are completed normally on the bus and then discarded. Read accesses to reserved or non-implemented registers complete normally and return a data value of 0.

The PCI Reset signal (RST#) resets all configuration registers to their default (power on) values. Software reset (ADPRST) has no effect on the configuration registers. Configuration register selection is sensitive only to the lower seven address lines. Thus, all I/O addresses are replicated throughout the entire 32-bit configuration address space. Table B-1 defines the supported PCI configuration registers and offsets. Detailed descriptions of each register follow Table B-1.

Table B-1 PCI Configuration Registers

Configuration Register	Operation	Identifier	I/O Address
Identification	Read only	CFID	0x00
Command and Status	Read and write	CFCS	0x04
Revision	Read only	CFRV	0x08
Cache and Latency	Read and write	CFCL	0x0C
Base I/O Address 0	Read and write	CIB0	0x10
Base I/O Address 1	Read and write	CIB1	0x14
Base Memory Address	Read and write	CBMA	0x18
Reserved	N/A	N/A	0x1C - 0x38
Interrupt	Read and write	CFIT	0x3C

Configuration ID Register (CFID)

The CFID register identifies the CIPCA adapter set. This register is read only. All reads return 0x06601095. Writes have no effect. Figure B-1 shows the CFID register bit fields.

Figure B-1 CFID Register Bit Fields

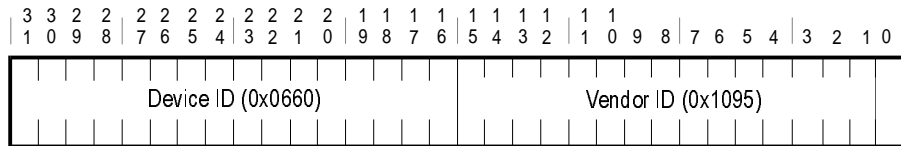

B-2 CIPCA Adapter Installation and User's Guide

Configuration Command and Status Register (CFCS)

The CFCS register is divided into command and status register fields. Figure B-2 shows the CFCS register bit fields.

The **command field** (bits 0 - 15) provides overall control of CIPCA's ability to generate and respond to PCI cycles. After reset, all bits in this register are set to zero. Writing zero (0) to this register logically disconnects the device from the PCI bus.

The **status field** (bits 16 - 31) records status information for PCI bus-related events. The status bits do not clear when read. Writing one (1) clears these bits. Writing zero (0) has no effect.

Figure B-2 CFCS Register Bit Fields

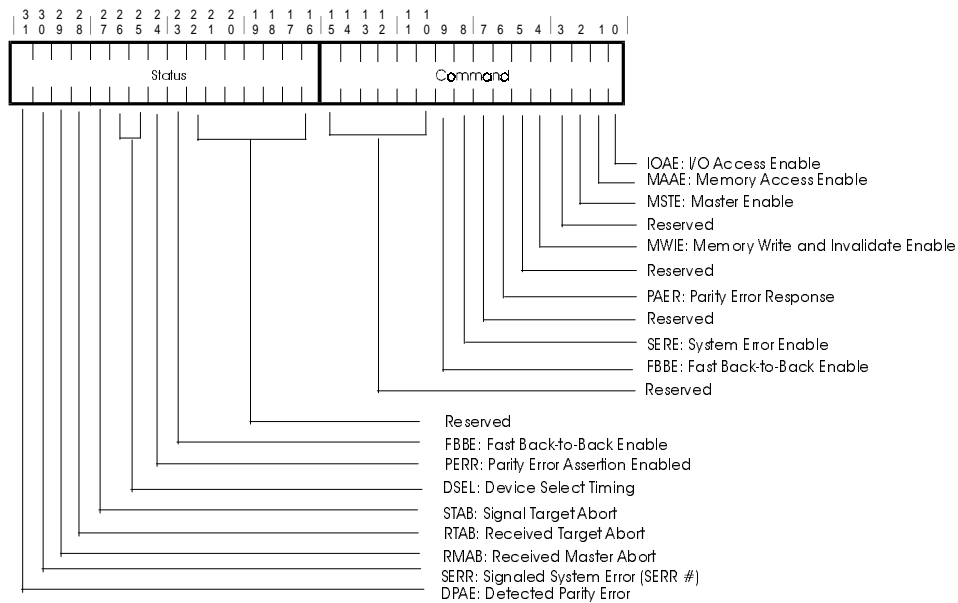

Configuration Revision Register (CFRV)

The CFRV register contains the CIPCA revision and class codes. This register contains the value 0xff000000 and is read only. Revision ID contains the revision of the CIPCA ASIC. Figure B-3 shows the CFRV register bit field ranges with class codes indicated.

Figure B-3 CFRV Register Bit Fields

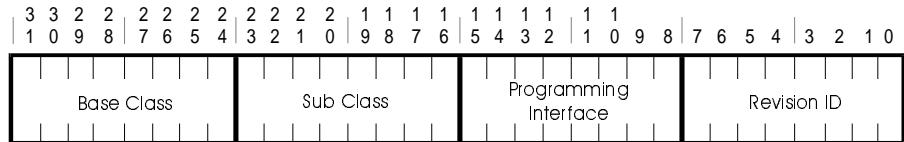

Configuration Cache and Latency Register (CFCL)

The CFCL register configures the latency timer and the cache line size values.

The **configuration latency timer** (bits <15:8>) is used when operating as a PCI bus master. This register specifies the value of the latency timer in units of PCI bus clocks (nanoseconds). The latency timer is initiated when FRAME_L is asserted. When the latency timer expires with FRAME_L still asserted, CIPCA initiates transaction termination as soon as GNT_L expires. The latency timer is invalidated if FRAME_L is deasserted with the latency timer still running.

The **cache line size** register specifies the system cache line size in longword (PCI doubleword) increments. If this register is zero (0), the PCI command “write and invalidate” is not used. Allowable values for this register are 0, 2, 4, 8, or 16.

Bits <31:16> are reserved (return 0 on reads). Figure B–4 shows the CFCL register bit fields.

Figure B–4 CFCL Register Bit Fields

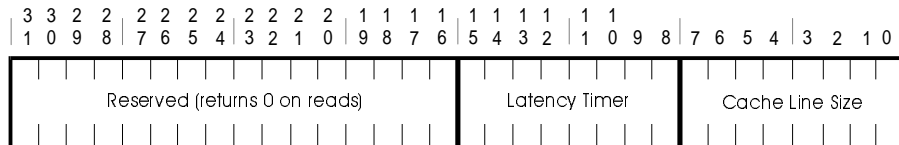

Configuration Base I/O Address Register 0 (CIB0)

The CIB0 register specifies the I/O address for accessing the CIPCA hard registers. This I/O space maps 256 bytes of the internal hard registers. Bit 0 is set on all reads, indicating that this is an I/O base register. Figure B-5 shows the CIB0 register bit fields.

Figure B-5 CIB0 Register Bit Fields

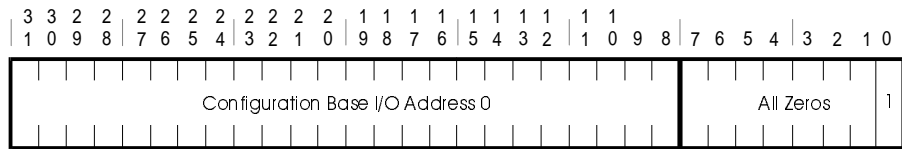

Configuration Base I/O Address Register 1 (CIB1)

The CIB1 register specifies the I/O address for accessing the CIPCA soft registers. Figure B-6 shows the CIB1 register bit fields.

Figure B-6 CIB1 Register Bit Fields

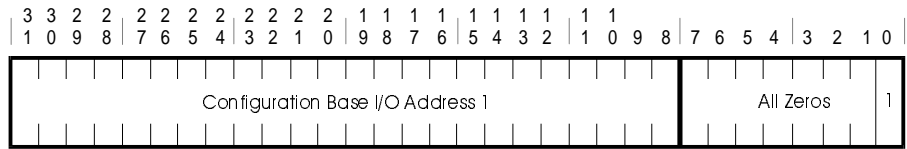

B.2 PCI ASIC Hard Registers

CIPCA contains six hard registers that are located within the PCI ASIC. These registers are accessed by the host using either the CIB0 or CMBA mapping registers.

Table B-3 defines each hard register, its offset, and function.

Table B-3 PCI ASIC Hard Registers

Hard Register	Operation	Identifier	CIB0 Offset	CBMA Offset	Effect
Adapter Reset	Write Only	ADPRST	0x00	0x00	A write causes a hardware reset on the port and link modules.
Clear Interrupt A	Write Only	CLRINTA	0x08	0x08	A write clears ASIC's state of INTA.
Clear Interrupt B	Write Only	CLRINTB	0x10	0x10	A write clears ASIC's state of INTB.
Interrupt Holdoff	Write Only	AITCR	0x18	0x18	A write forces the link module holdoff timer to reset its expiration time. No additional INTA signal can be posted until the holdoff timer has expired.
Node Status	Read and Write	NODESTS	0x20	0x20	Shows state of INTA and INTB internal signals. See Figure B-1 and Table B-1.
Interrupt Enable	Read and Write	INTENA	0x28	0x28	Enables or disables host system interrupts. Default is zero (interrupts disabled). See Figure B-10 and Table B-5.

Node Processor Status Register (NODESTS)

Figure B-9 shows the bit fields of the Node Processor Status register. Table B-4 identifies and describes the NODESTS bit fields. Table B-4a describes the field definitions of the ADPSTA bit range. Table B-4b defines extended error information that is located in the CASR <ACC> field.

Figure B-9 NODESTS Register Bit Fields

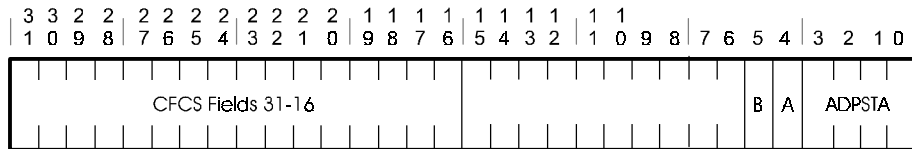

Table B-4 NODESTS Register Bit Field Functions

Field	Identifier	Description
31:16	CFCS	An alternate path to the configuration space CFCS register.
5	INTB	Not used by CIPCA.
4	INTA	When clear, the local node processor has not requested the posting of INTA. Presentation of this value is delayed by the interrupt holdoff timer.
3:0	ADPSTA ¹	At reset, this field is defined as zero (0). Once the processor module has completed diagnostics and has transitioned to N_PORT INITIALIZED, this field is set to 1. If any error occurs, the field is set to a value greater than 1. Once a non-zero value is posted, it remains set until an ADPRST is issued.

¹ See Table B-4a for a description of the bit definitions for this field.

Table B-4a ADPSTA Field Definitions

Field	Identifier	Description
0	INPROCESS	Initialization is in process. If this exceeds ten seconds, a catastrophic hardware failure has occurred.
1	INIT	“Reset Initialization” completed, ready for NPORT initialization or microcode download.
2	INV_UCODE	Microcode checksum in PROM is invalid.
3	CPURAM_BAD	Microprocessor SRAM test failed.
4	BUFRAM_BAD	Buffer SRAM test failed.
5	CABLESWAP	Intermodule ribbon cables are swapped.
6	CI_PATHA	CI path A is bad. ¹
7	CI_PATHB	CI path B is bad. ¹
8	NODADR_ MISMATCH	Node address for CI Path A does not agree with Path B.
9	CLUSIZ_ MISMATCH	Cluster size for CI Path A does not agree with Path B.

¹Table B-4b defines extended error information that is located in the CASR <ACC> field.

Table B-4b ACC Values when ADPSTA is CI_PATHA or CI_PATHB

Field	Identifier	Description
1	DATATEST	Data miscompare was detected using Data Test Register.
2	TXTO	Timeout occurred waiting for Tx interrupt during CI loopback test.
3	TXSTS	Bad status detected in Tx ring status field during CI loopback test.
4	RXTO	Timeout occurred waiting for Rx interrupt during CI loopback test.
5	RXSTS	Bad status detected in Rx ring status field during CI loopback test.
6	MISCOMP	Data miscompare was detected during CI loopback test.

Interrupt Enable Register (INTENA)

Interrupt Enable (INTENA) is a read/write register used to enable or disable host system interrupts. The default value upon reset is zero (0). Figure B-10 shows the INTENA register bit fields. Table B-5 describes the INTENA register bit fields.

Figure B-10 Interrupt Enable Register Bit Fields

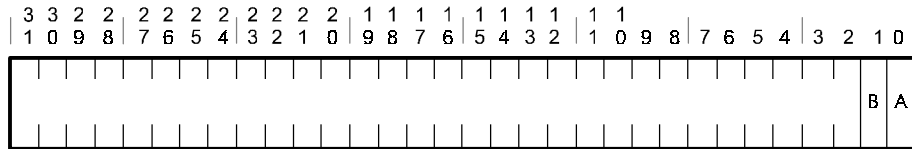

Table B-5 Interrupt Enable Register Bit Field Descriptions

Field	Identifier	Description
0	ENAA	Clear (0) = an interrupting condition for INTA is not presented in the INTA# signal. Set (1) = interrupting conditions are presented to the INTA# signal. The internal value of INTA (status of interrupting condition) is read at NODESTS.
1	ENAB	Clear (0) = interrupting conditions for INTB are not presented to INTB# signal. Set (1) = interrupting conditions are presented to the INTB# signal. The internal value of INTB (status of interrupting condition) is read at NODESTS.

B.3 Soft Registers

Soft registers are locations that exist within CIPCA's SRAM buffer and have full byte, word, and longword (PCI doubleword) read/write access capabilities. All soft registers are 64 bits. The registers are accessed high-order longword followed by low-order longword. On register writes, only the low-order longword needs to be issued to signal the adapter.

Addressing Conventions

These registers are addressed beginning at offset 0x0 from CIB1 or from offset 0x100 from CBMA. The ASIC soft register sequences provide for full read and write access to all soft registers. Table B-6 contains the definitions for each soft register and its appropriate offset.

Table B-6 Soft Register Definitions and Offsets

Soft Register	Operation	Identifier	CIB1 Offset	CBMA Offset
Adapter Block Base	Read and Write	ABBR	0x00	0x100
Channel Command Queue 2 Insertion	Write only	CCQ2IR	0x08	0x108
Channel Command Queue 1 Insertion	Write only	CCQ1IR	0x10	0x110
Channel Command Queue 0 Insertion	Write only	CCQ0IR	0x18	0x118
Adapter Datagram Free Queue Insertion	Write only	ADFQIR	0x20	0x120
Adapter Message Free Queue Insertion	Write only	AMFQIR	0x28	0x128
Channel/Adapter Status	Read only	CASR ¹	0x30	0x130
Channel/Adapter Failing Address	Read only	CAFAR	0x38	0x138
Channel/Adapter Status Release Control	Write only	CASRCR	0x40	0x140
Channel Initialize Control	Write only	CICR	0x48	0x148
Channel Enable Control	Write only	CECR	0x50	0x150
Adapter Maintenance/Sanity Timer Control	Write only	AMTCR	0x58	0x158
Adapter Maintenance/Sanity Timer Expiration	Write only	AMTECR	0x60	0x160
Adapter Maintenance Control and Status	Read and write	AMCSR	0x68	0x168
ACC Extension Register	Read and write	ACCX ²	0x70	0x170
Unused	--		0x78 - 0xe0	0x178 - 0x1e0

(continued on next page)

Table B-6 Soft Register Definitions and Offsets (cont.)

Soft Register	Operation	Identifier	CIB1 Offset	CBMA Offset
Microcode Revision and Status	Read only	MREV ²	0xe8	0x1e8
Microcode Update Status Register	Read and write	MUSR ²	0xf0	0x1f0
Microcode Update Control and Address	Write only	MUCAR ²	0xf8	0x1f8
Unused	--		N/A	0x200
Alternate Clear Interrupt A	Write only	ALT_ CLRINTA ²	N/A	0x208
Alternate Interrupt Holdoff	Write only	ALT_ AITCR ²	N/A	0x218
Alternate Interrupt Enable	Write only	ALT_ INTENA ²	N/A	0x228

¹Specification deviates from N_PORT, ²CIPCA-specific registers

Addresses in CIPCA Soft Registers

All soft registers that contain physical addresses are a nonadjusted host address. Table B-7 defines the valid bits within an address register.

Table B-7 CIPCA Soft Register Definition

Bits	Definition
63 to 32	Must be Zero
31 to 0	Physical Addresses <31 to 0>

Carrier Soft Registers

All registers that contain an address to a carrier **MUST** have the address of the new Tail Pointer written. The CIPCA firmware uses the tail pointer in the soft registers to terminate N_PORT queue operations.

Channel/Adapter Status Register (CASR)

The Channel/Adapter Status Register returns status to the port driver after either a miscellaneous or response interrupt. CIPCA uses the Adapter Single Interrupt Completion bit (ASIC) to indicate that the adapter is requesting a completion interrupt. To restrict slave register accesses on normal interrupt processing, CIPCA's interrupt model is as follows:

- Reads of CASR with only IC|EC|ASIC bits set must not acknowledge the interrupt (by writing CASRCR). The read of CASR always clears the hardware presentation of INTA. New status can be posted after the CASR read has occurred.
- Reads of CASR with other bits set must be acknowledged with the write to CASRCR. The read of CASR dismisses the hardware status of INTA. No new status is posted from the adapter until a write of CASRCR has occurred.

The CASR ACC field is defined as a full 16-bit error code. All additional information to this error can be found in the ACCX register. Table B-8 lists all defined ACC values for conditions when CASR<ACC> is set.

Table B-8 ACC Values when CASR<ACC> Is Set

Value	Identifier	Description
0x10	BAD_PTR	Out of range data structure pointer passed to "free" routine.
0x11	NOT_FREE	Data structure to be "freed" still linked to a queue.
0x12	INSANE	General error code reports some "insane" firmware condition.
0x13	PCIDMA0_INT	PCI DMA engine 0 interrupt found pending. Should never be enabled.
0x14	INV_CONTENT	Value of PCI DMA engine 1 content counter > 3.
0x15	PORTREG_RDINT	Port register read interrupt found pending. Should never be enabled.
0x16	PORTREG_INVLD	An unexpected Port Register access by the host has occurred.

(continued on next page)

Table B-8 ACC Values when CASR<ACC> Is Set (cont.)

Value	Identifier	Description
0x17	INVLD_XQE_LEN	DQE_LEN or MQE_LEN in Adapter Block is greater than IBUF_LEN.
0x18	ABBR_BAD	SBZ fields in ADDR Register are not zero.
0x19	QPTR_STOPPER	A Driver to Adapter Queue entry was not recognized.
0x1a	MTD_AMTECR	AMTECR was written while MTD in AMCSR is set.
0x1b	PCIDMA0	Error status detected in PCI DMA Ring for DMA engine 0.
0x1c	PCIDMA1	Error status detected in PCI DMA Ring for DMA engine 1.
0x1d	PE	A parity error was detected. The specific parity error type is found in byte 0 of the ACCX<XERR> register. If the parity error type is PCI, byte 1 of the XERR field gives further definition.
0x1e	CI_INV_RTX	An invalid set of conditions exists which make up the retransmit dispatch index.
0x1f	CI_TX_PARERR	Parity error detected in Tx Ring status field.
0x20	CI_TX_UNDERUN	Underrun detected in Tx Ring status field.
0x21	CI_TX_NOPATH	No Tx path available when VC was open.
0x22	CI_RX_PARERR	Parity error detected in Rx Ring status field.
0x23	CI_ASIC0_RXFAIL	Fatal error detected in CI ASIC 0 internal receive status register.
0x24	CI_ASIC1_RXFAIL	Fatal error detected in CI ASIC 1 internal receive status register.

(continued on next page)

Table B-8 ACC Values when CASR<ACC> Is Set (cont.)

Value	Identifier	Description
0x25	CI_ASIC0_TXFAIL	Fatal error detected in CI ASIC 0 internal transmit status register.
0x26	CI_ASIC1_TXFAIL	Fatal error detected in CI ASIC 1 internal transmit status register.
0x27	NRP1_NULL	Pointer to “NR Plus 1” buffer was NULL while “waiting for NR Plus 1.”
0x28	MACHINE_CHECK	The microprocessor encountered a miscellaneous exception.

ACC Extension Register (ACCX)

Figure B-11 shows ACCX register bit ranges. The Line and Module fields are firmware release dependent and only useful to the firmware maintainer. Values for XERR are dependent upon select ACC error codes. Table B-9 describes the values of XERR for select ACC errors.

Figure B-11 ACCX Extension Register

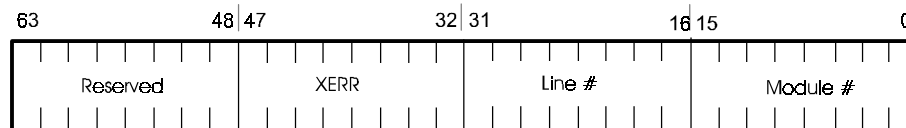

Table B-9 XERR Values for Select ACC Errors

ACC Error Code	XERR Description
PCIDMA0	PCI DMA Ring Status
PE	The specific parity error type is found in byte 0. If the parity error type is PCI, byte 1 provides further definition.
CI_INV_RTX	The dispatch index.

(continued on next page)

Table B-9 XERR Values for Select ACC Errors

ACC Error Code	XERR Description
CI_TX_PARERR	0 = CI ASIC 0, 1 = CI ASIC 1
CI_TX_UNDERUN	0 = CI ASIC 0, 1 = CI ASIC 1
CI_TX_NOPATH	0 = CI ASIC 0, 1 = CI ASIC 1
CI_RX_PARERR	0 = CI ASIC 0, 1 = CI ASIC 1
CI_ASIC0_RXFAIL	Contents of internal status register.
CI_ASIC1_RXFAIL	Contents of internal status register.
CI_ASIC0_TXFAIL	Contents of internal status register.
CI_ASIC1_TXFAIL	Contents of internal status register.

Module and Firmware Revision Register (MREV)

The Module and Firmware Revision Register is used to present the module hardware revision, hardware capabilities, and current executing firmware revision. This register is valid only when NODESTS is non-zero. Figure B-12 shows the MREV bit fields. Table B-10 describes the contents of each field.

Figure B-12 Module and Firmware Revision Register (MREV)

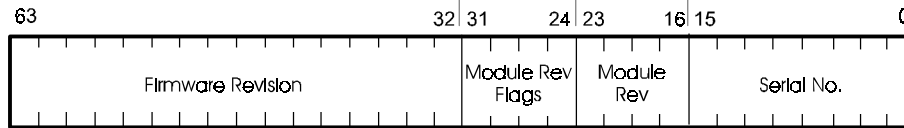

Table B-10 MREV Field Definition

Field	Description
SERIAL	Two-byte little-endian value
MODREV	ASCII presentation of the PCI PCB major revision
MODFLG	Module capabilities bit field (see below)
	bit value
	0 Alternate interrupt hardware present
	1 - 7 reserved
FWREV	ASCII presentation of the Firmware revision (4 bytes)*

*The FWREV field always contains ASCII readable characters. Treat this as a character string. Byte 0 is the first character and byte 3 is the last byte. The upper two bytes must contain a hex representation of an increasing revision value.

Microcode Update Status Register (MUSR)

MUSR is used to present the state and status of a microcode update sequence. It is only valid when ADPSTA has a value of either 1 or 2. Figure B-13 shows the bit fields in the MUSR register. Table B-11 describes the contents of each field. Table B-12 contains the field definitions for the Status (STS) field of the MUSR register.

Figure B-13 Microcode Update Status Register (MUSR)

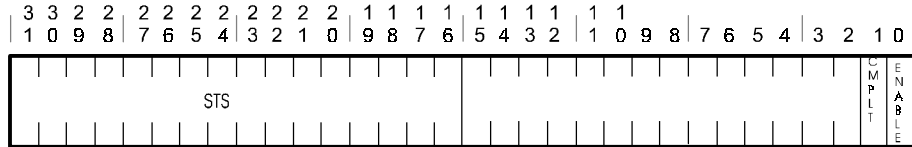

Table B-11 Microcode Update Status Register Description (MUSR)

Field	Identifier	Description
31:16	STS	This field provides a completion status of a microcode load attempt. Table B-12 defines the acceptable values for this field. This field is only valid when CMLT is set.
1	CMLT	When set (1), indicates that the microcode load sequence is complete. Completion status can be found in the STS field.
0	ENAB	When set (1), indicates that the sequencer is at ST7.

Table B-12 MUSR STS Field Definition

Status	Description
1	Indicates a successful load. Image downloaded, verified, and written in FLASH.
2	HCLB (Host Load Control Block) was not found at the specified DMA address.
3	The computed CRC of the downloaded image does not match the HLCB IMAGE_CRC value.
4	The HLCB IMAGE_SIZE is invalid. Either too large or too small.
5	The HLCB BASE_ADDR is out of range.
6	The HLCB Structure Revision is not supported.
7	The HLCB JMP_ADDR is out of range.
8	Written FLASH image does not compare. This indicates a hardware problem with the AMD FLASH part.
9	An error occurred while writing to the AMD FLASH part.

Appendix C

DECevent Examples

This appendix contains samples of error reports generated from the DECEvent utility (version V2.1). These examples are presented only to show where to look for the error type and the device that detected the error.

For information on using the DECEvent utility, consult the DECEvent documentation listed in the Preface.

Example C-1 is an example of a software error. In this example, the error type is identified in the "Logged Message Type Code" field, and the device that identified the error is identified in the "Format Type" field. The messages at the end of the DECEvent examples can also be helpful in identifying and locating the problem; These areas are indicated in boldface.

Example C-1

```
Logging OS                1. OpenVMS
System Architecture       2. Alpha
OS version                V6.2
Event sequence number    684.
Timestamp of occurrence  09-AUG-1995 20:03:57
Time since reboot        1 Day(s) 7:16:01
Host name                FLAM29

System Model              AlphaServer 2100 4/200

Entry type                100. Logged Message

---- Device Profile ----
Unit                      FLAM29$PNA0
Product Name              CIPCA (PCI to CI Adapter)

---- MSCP Logged Msg ----

Logged Message Type Code      3. Port Message

Error Type/SubType        x4007  Signaled via Packet, Error Logging
                          Datagram Received.
Count - Remaining Retries  50.
Count - Allowable Retries  0.

Error Count                4.
Local Station Address      x0000000000000009
Local Station ID           x000000000000FC5E
Remote Station Address     x0000000000000003
Remote Station ID         x0000000000000003

NPPD Opcode                x01  Port Message Received
```

```

NPPD Channel Index          x00
NPPD Flags                  x0000
NPPD Status                  x0200  Packet Processed Correctly
                               Status Type:  OK Status
                               Receive Path:  Path B

NPPD Body Opcode            x01  DG
NPPD Body Flags              x00
NPPD Destination Subnode    0.
NPPD Destination PGRP Prt   9.
NPPD Source Subnode         0.
NPPD Source PGRP Port       3.

Message Type                 5.  Error Log Datagram
Sequence Number              160.
Format Type                 1.  HSC Binary Out-Of-Band
Nodename                     HSC003
Parameter[0] - Event Code    204
Parameter[x]                  x00C3
Parameter[x]                  x0005
Parameter[x]                  x0002

DISK-E Seq 160. at 9-Aug-1995 20:03:56.96, Out-of-band 000204
Unrecoverable error on disk unit 195. Drive appears inoperable

```

Example C-2 is an example of a hardware error. In this example, the error type is identified in the “Logged Message Type Code” and “Error type/SubType” fields. Hardware errors are commonly associated with the Product Name field listed in the Device Type area, in this case, the CIPCA adapter itself. These areas are indicated in boldface in the example below.

Example C-2

```

Logging OS                1. OpenVMS
System Architecture      2. Alpha
OS version              V6.2
Event sequence number   694.
Timestamp of occurrence 09-AUG-1995 20:49:13
Time since reboot       1 Day(s) 8:01:17
Host name               FLAM29

System Model            AlphaServer 2100 4/200
Entry type              100. Logged Message

---- Device Profile ----
Unit                   FLAM29$PNA0
Product Name           CIPCA (PCI to CI Adapter)

---- MSCP Logged Msg ----
Logged Message Type Code      3. Port Message
Error Type/SubType           x4100 Cable Status Change, Path 0.
                               went from GOOD to BAD.
Count - Remaining Retries  50.
Count - Allowable Retries  0.

Error Count             5.
Local Station Address   x00000000000000009
Local Station ID       x0000000000000FC5E
Remote Station Address x00000000000000009
Remote Station ID      x0000000000000FC5E

```

NPPD Opcode	x00	Port Message
NPPD Channel Index	x00	
NPPD Flags	x4000	Path Select: Path A
NPPD Status	x0101	Command Succeeded but Path Failed. Status Type: OK Status Path A Status: NACK (Failure) Path B Status: ACK (Success) or
Not used		
NPPD Body Opcode	x0B	ID
NPPD Body Flags	x10	
NPPD Destination Subnode	0.	
NPPD Destination PGRP Prt	9.	
NPPD Source Subnode	0.	
NPPD Source PGRP Port	9.	

Index

A

- Adapter reset register, B-11
- ADPSTA field definitions \t, B-12
- Alpha Firmware Update CD-ROM, 4-1
- AlphaServer 2000
 - show config command, 3-16
 - show device command, 3-17
- AlphaServer 2100
 - CIPCA installation procedure, 2-15
- AlphaServer 2100/2100A
 - show config command, 3-10
 - show device command, 3-12
- AlphaServer 2100A
 - CIPCA installation procedure, 2-18
- AlphaServer 4000/4100
 - CIPCA installation procedure, 2-13
 - LFU output, 4-9
 - show config command, 3-6
 - show device command, 3-8
- AlphaServer 8200/8400
 - CIPCA installation procedure, 2-9
 - LFU output, 4-5
 - show config command, 3-3
 - show device command, 3-4

B

- Boot methods
 - setting CIPCA as default boot device, 3-18
 - setting CIPCA to autoboot, 3-20
 - setting multiple CIPCA as default boot device, 3-19
 - simple boot, 3-18
- boot_device parameter, 3-18
- Boot_file parameter, 3-18

- Boot_osflags parameter, 3-18
- Boot_reset parameter, 3-18
- Bootdef_dev parameter, 3-18
- Booted_dev parameter, 3-18
- Booted_file parameter, 3-18
- Booted_osflags parameter, 3-18
- Booting
 - AlphaServer 8200/8400 display, 3-21
 - displaying boot information, 3-18
- Booting disks, 3-18

C

- Cable sets, 2-4
- Cables
 - 60-pin intermodule, 2-2, 2-3
 - BNCIA, 2-4
 - CI transition, 2-2, 2-3
 - CI transition cable, 1-2
 - Intermodule (ribbon) cables, 1-2
 - ribbon, 2-2, 2-3
- Cache line size, B-5
- CASR register
 - ACC values when CASR is set. *See* Table B-8
- Channel/adaptor status register (CASR), B-19
- CI transition cable, 1-2
- CIPCA
 - CI transition cable, 1-2
 - functional overview, 1-4
 - general description, 1-1
 - intermodule (ribbon) cables, 1-2
 - link module, 1-2
 - physical description, 1-2
 - port module, 1-2
 - systems supporting, 1-1
- CIPCA-AA, 1-1
- CIPCA-AA kit contents, 2-2
- CIPCA-BA, 1-1
- CIPCA-BA kit contents, 2-3
- Clear interrupt A register, B-11

- Clear interrupt B register, B-11
- Cluster size
 - setting DIP switch. *See* Table 2-5
- Configuration base i/o address 0 (CIB0), B-6
 - bit fields. *See* Figure B-5
- Configuration base i/o address 1 (CIB1), B-7
 - bit fields. *See* Figure B-6
- Configuration base memory address (CBMA), B-8
 - bit fields. *See* Figure B-7
- Configuration cache and latency register (CFCL)
 - bit fields. *See* Figure B-4
- Configuration command and status register (CFCS), B-3
 - bit fields. *See* Figure B-2
- Configuration ID register (CFID), B-2
 - bit fields. *See* Figure B-1
- Configuration interrupt register (CFIT), B-9
 - bit fields. *See* Table B-2. *See* Figure B-8
- Configuration latency timer, B-5
- Configuration revision register (CFRV), B-4, B-5
 - bit fields. *See* Figure B-3
- Configurations supported, 1-3
- Contents
 - CIPCA-AA adapter kit, 2-2
 - CIPCA-BA adapter kit, 2-3

D

- diagnose command, 5-8
- DIP switches on link module
 - location, 2-5
 - setting, 2-4

E

- Electrical specifications, A-1
- Environment variable
 - boot_file, 3-18
 - boot_osflags, 3-18
 - boot_reset, 3-18

- bootdef_dev, 3-18
- booted_dev, 3-18
- booted_file, 3-18
- booted_osflags, 3-18
- Environment variables
 - boot_device, 3-18
- Environmental specifications, A-1
- Extender bracket
 - offset, 2-2, 2-3
 - straight, 2-2, 2-3
- Extender brackets
 - attaching, 2-7
- External cable sets, 2-4
- External cables, connecting, 2-23

F

- Field definitions (ADPSTA). *See* Table B-4a
- Firmware
 - CIPCA requirements, 4-2
 - console requirements for CIPCA, 4-2
 - update procedure overview, 4-3
- Firmware updates, via Internet, 4-1
- Functional overview, 1-4

H

- Host adapters supported, 1-3
- Host systems, 1-3
- HSCs supported, 1-3

I

- Installation overview, 2-1
- Installation procedure
 - on AlphaServer 2000, 2-19
 - on AlphaServer 2100, 2-14
 - on AlphaServer 2100A, 2-15
 - on AlphaServer 4000/4100, 2-12
 - on AlphaServer 8200/8400, 2-9
- Intermodule (ribbon) cables, 1-2
- Interrupt enable register, B-11
- Interrupt holdoff register, B-11

L

- LFU filenames, 4-4

Link module, 1-2, 2-2, 2-3
Loadable firmware utility
 filenames for AlphaServer
 systems, 4-4

N

Node ID
 setting DIP switch. *See* Table 2-4
Node processor status register
 (NODESTS), B-12
 bit field functions. *See* Table B-4
 bit fields. *See* Figure B-9
Node status register, B-11

O

Operating system
 version, 1-3

P

PCI ASIC hard registers, B-1, B-10.
 See Table B-3
PCI configuration registers, B-1. *See*
 Table B-1
 base memory address, B-2
 cache and latency, B-2
 command and status, B-2
 i/o base address 0, B-2
 i/o base address 1, B-2
 identification, B-2
 interrupt, B-2
 revision, B-2
Port module, 1-2, 2-2, 2-3
Power-up display
 AlphaServer 2000, 3-14
 AlphaServer 2100/2100A, 3-9
 AlphaServer 4000/4100, 3-5
 AlphaServer 8200/8400, 3-2

R

Register definitions, B-1
Registers
 accesses supported, B-1
 ADPRST, B-1
 ASIC hard, B-1

channel/adaptor status (CASR),
 B-19
configuration base i/o address 0
 (CIB0), B-6
 bit fields. *See* Figure B-5
configuration base i/o address 1
 (CIB1), B-7
 bit fields. *See* Figure B-6
configuration base memory
 address (CBMA), B-8
 bit fields. *See* Figure B-7
configuration cache and latency
 (CFCL), B-5
 bit fields. *See* Figure B-4
configuration command and
 status (CFCS), B-3
configuration command and
 status ID (CFCS)
 bit fields. *See* Figure B-2
configuration ID (CFID), B-2
 bit fields. *See* Figure B-1
configuration interrupt (CFIT),
 B-9
 bit field functions. *See* Table
 B-4. *See* Table B-2
 bit fields. *See* Figure B-9.
 See Table B-3. *See*
 Figure B-8
configuration revision (CFRV),
 B-4
 bit fields. *See* Figure B-3
node processor status
 (NODESTS), B-12
PCI ASIC hard, B-10
PCI configuration, B-1
soft, B-1

Requirements

software, 1-5
Ribbon cables, connecting, 2-22
Ribbon cables, dressing, 2-9

S

Show config command
 AlphaServer 2000, 3-16
 AlphaServer 2100/2100A, 3-10

- AlphaServer 4000/4100, 3-6
- AlphaServer 8200/8400, 3-3
- Show device command
 - AlphaServer 2000, 3-17
 - AlphaServer 2100/2100A, 3-12
 - AlphaServer 4000/4100, 3-8
 - AlphaServer 8200/8400, 3-4
- Soft register definitions. *See* Table B-7
- Soft registers, B-1
 - addresses in, B-18
- Software requirements, 1-5

T

- Troubleshooting
 - CIPCA error codes, 5-4
 - CIPCA initialization codes, 5-3
 - LED codes, 5-3
 - port module LEDs, 5-1

U

- Updating firmware
 - 2000/2100/2100A, 4-11
 - 4000/4100, 4-9
 - 8200/8400, 4-5