

This drawing and specifications, herein, are the property of Digital Equipment Corporation and shall not be reproduced or copied or used in whole or in part as the basis for the manufacture or sale of items without written permission.

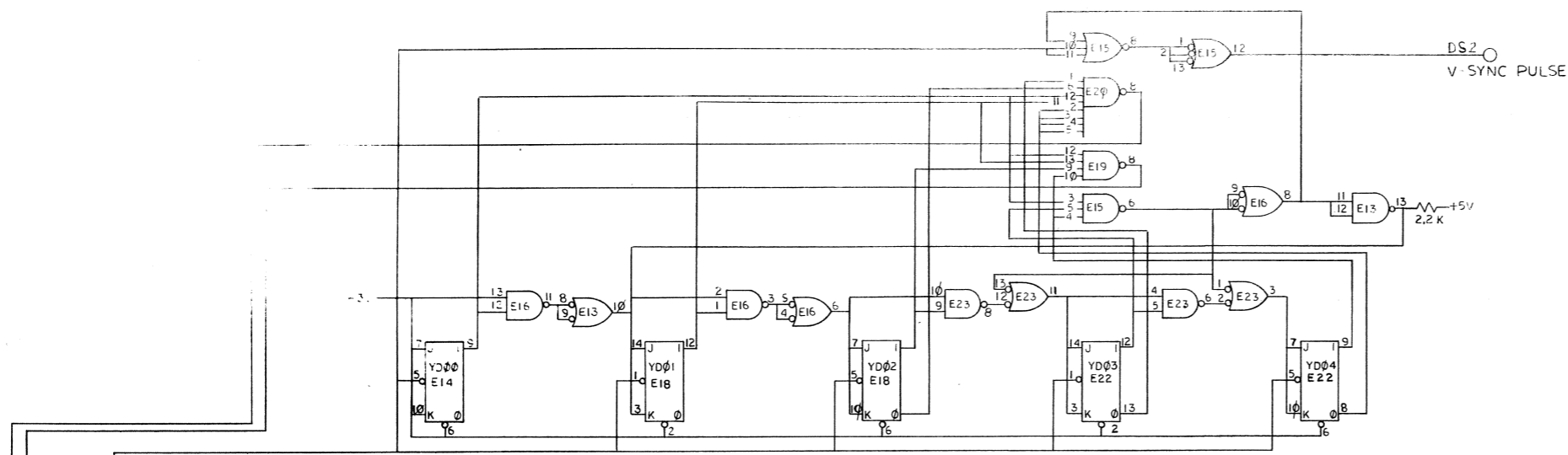

1.56 KHZ CLOCK (60 HZ MODELS)
1.3 KHZ (50 HZ MODELS)
YD00 (I) = JK YD01

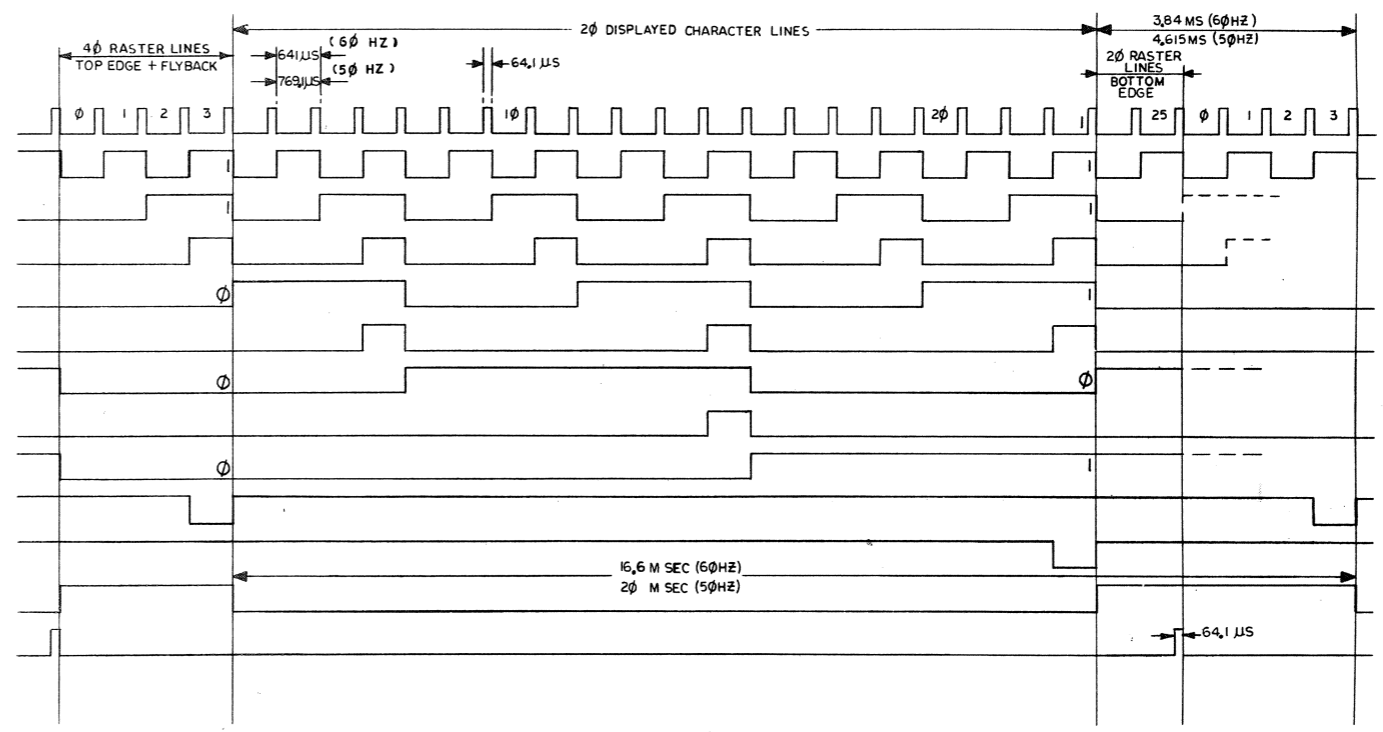

REV	CHG	NO.

FIRST USED ON OPTION/MODEL VT05	QTY.	DESCRIPTION	PART NO.	ITEM NO.
UNLESS OTHERWISE SPECIFIED				
DIMENSION IN INCHES		DATE 4/12/71		
TOLERANCES		DATE 4/12/71		
DECIMALS	FRACTIONS	ANGLES	DATE 6/16/71	
= .005	= 1/64	= 0°30'	DATE 6/16/71	
FINAL SURFACE QUALITY		DATE 4/12/71		
REMOVE BURRS AND BREAK SHARP CORNERS		DATE 4/12/71		
MATERIAL	NEXT HIGHER ASSY			
+	A-ML-VT05-0			
FINISH	SCALE			
+	SHEET 1 OF 1			
TITLE		PARTS LIST		
DYNAMIC Y COUNTER		digital EQUIPMENT CORPORATION MAYNARD, MASSACHUSETTS		
NUMBER		REV.		
DTC VT05-0-03		M-7002		

This drawing and specifications, herein, are the property of Digital Equipment Corporation and shall not be reproduced or copied or used in whole or in part as the basis for the manufacture or sale of items without written permission.

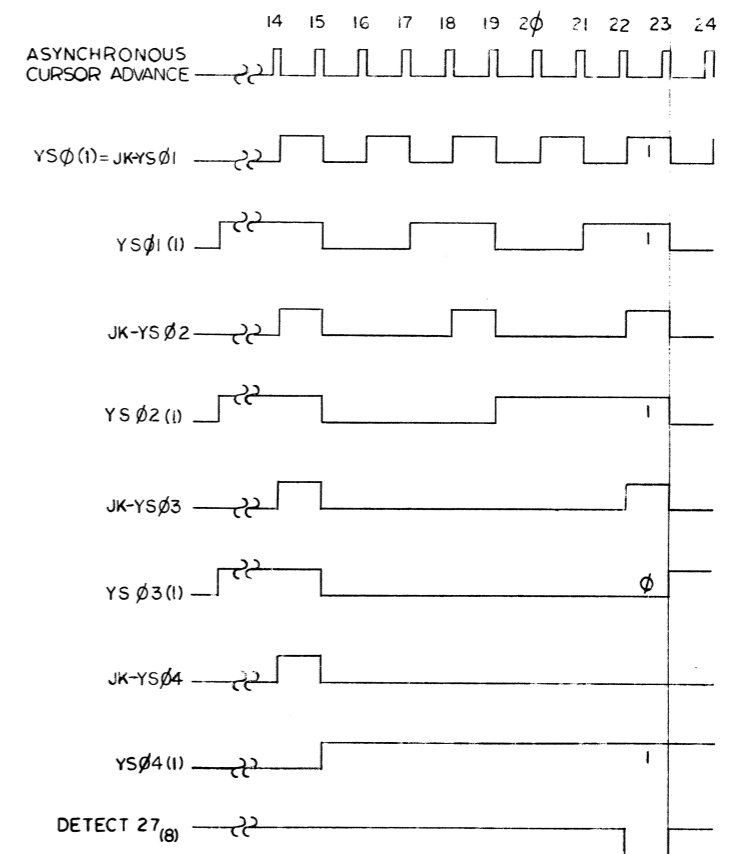
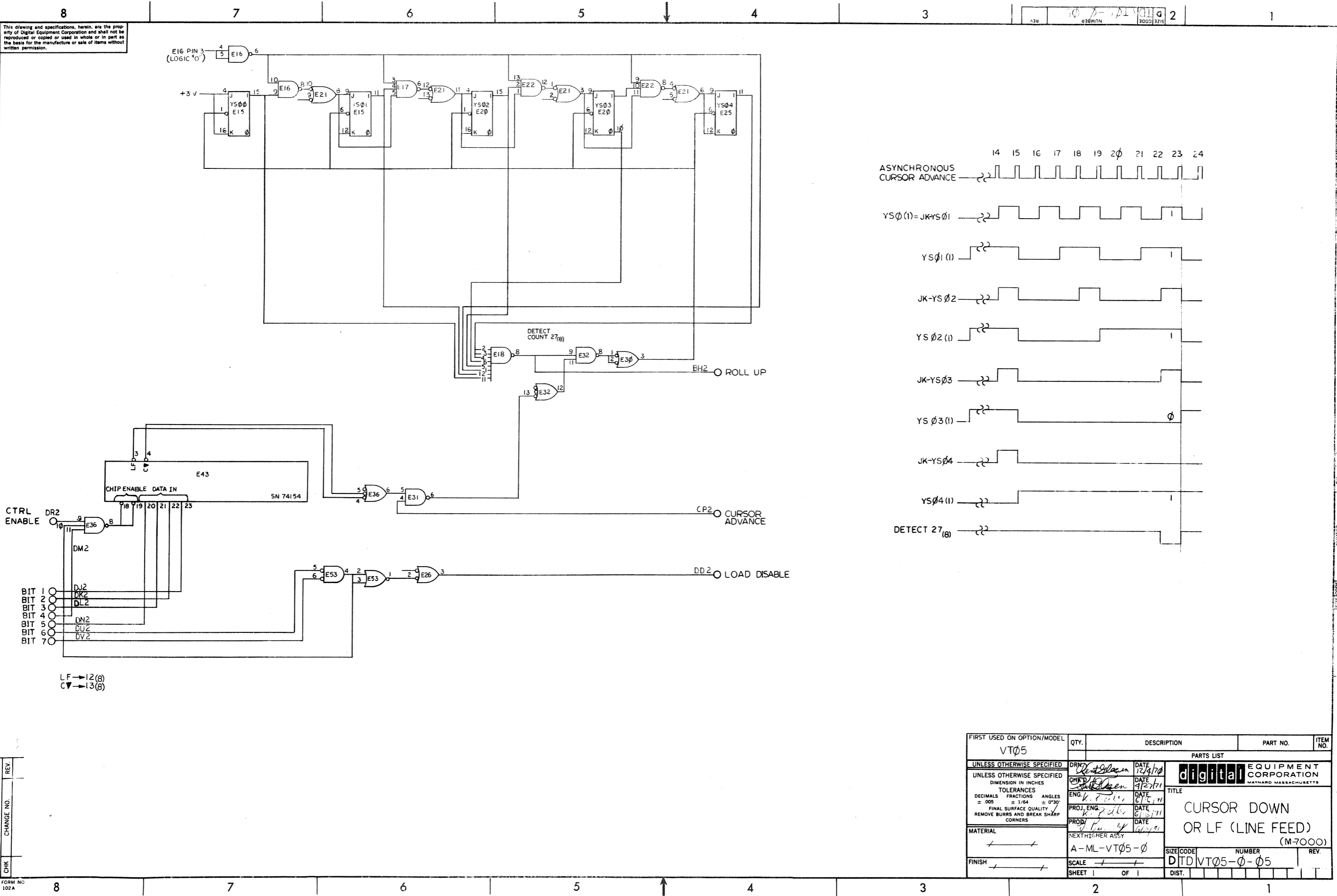

REV	CHANGE NO.

FIRST USED ON OPTION/MODEL VT05	QTY.	DESCRIPTION	PART NO.	ITEM NO.
PARTS LIST				
UNLESS OTHERWISE SPECIFIED	DRN	DATE	 digital EQUIPMENT CORPORATION MAYNARD, MASSACHUSETTS	
DIMENSION IN INCHES	CHK	DATE		
TOLERANCES	ENG	DATE		
DECIMALS FRACTIONS ANGLES	PROJ. ENG.	DATE		
± .005 ± 1/64 ± 0°30'	PROJ.	DATE	TITLE CURSOR DOWN OR LF (LINE FEED) (M-7000)	
FINAL SURFACE QUALITY REMOVE BURRS AND BREAK SHARP CORNERS				
MATERIAL	NEXT HIGHER ASSY		SCALE	REV.
FINISH	A-ML-VT05-0		SHEET 1 OF 1	NUMBER
DITDVT05-0-05			DIST.	

SIZE CODE NUMBER
 DITDVT05-0-05

This drawing and specifications, herein, are the property of Digital Equipment Corporation and shall not be reproduced or copied or used in whole or in part as the basis for the manufacture or sale of items without written permission.

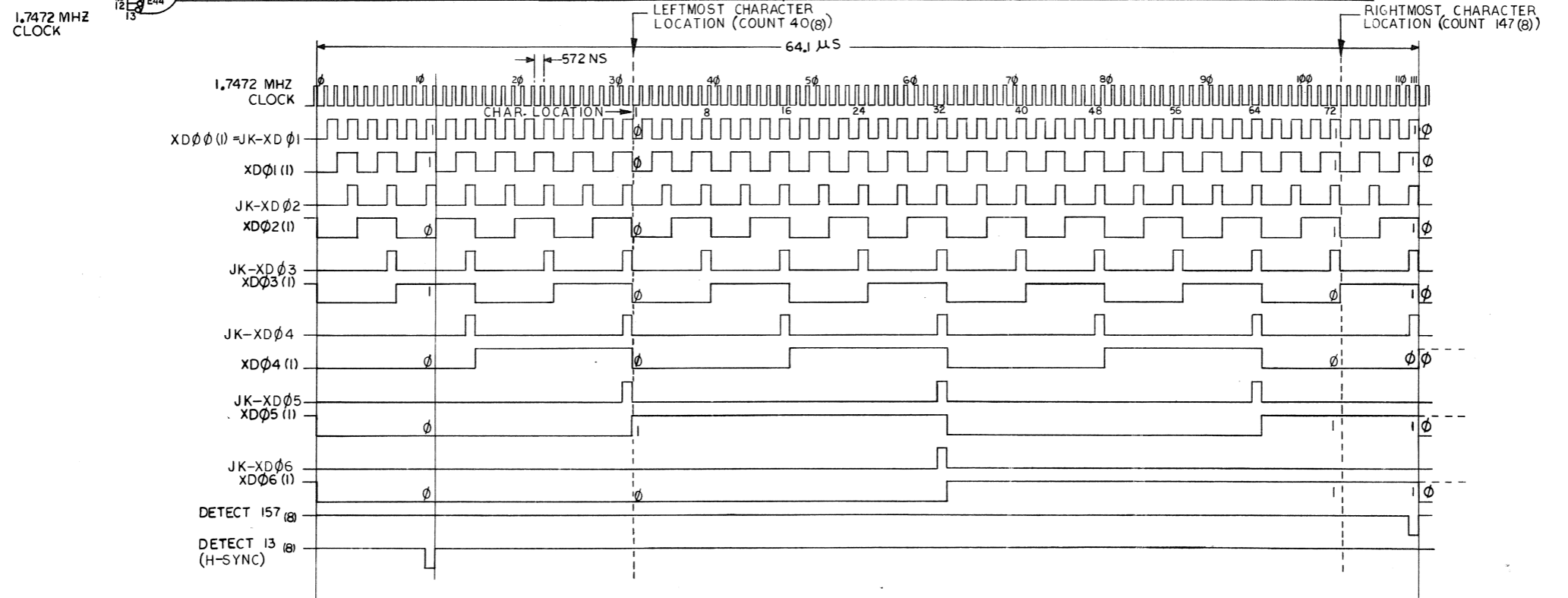
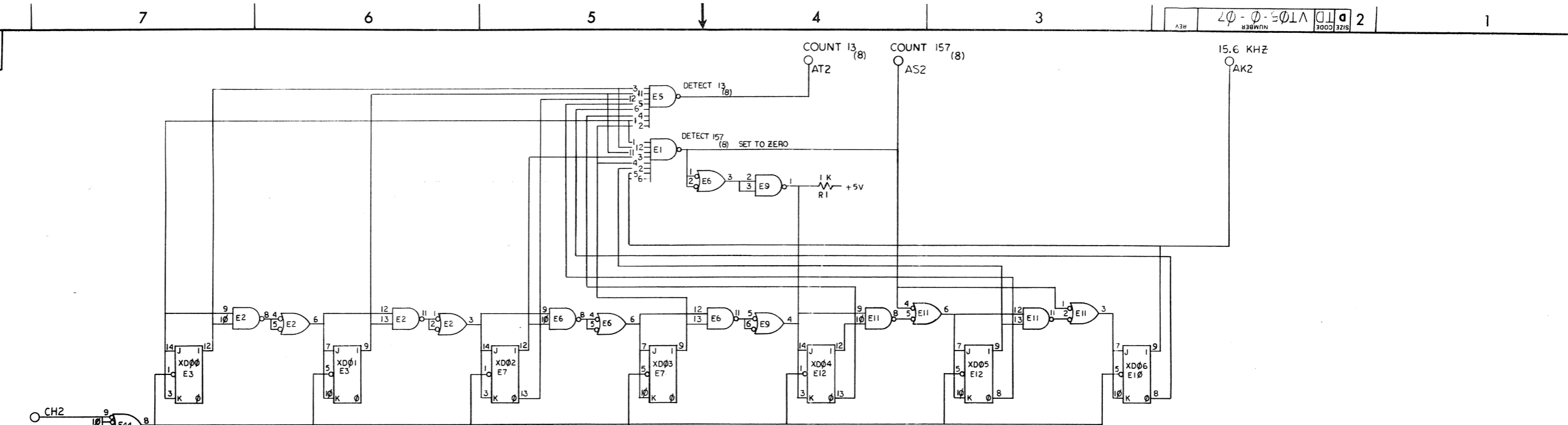

REV	CHANGE NO.

DEC FORM NO. 102A

FIRST USED ON OPTION/MODEL	QTY.	DESCRIPTION	PART NO.	ITEM NO.
VT05				
PARTS LIST				
UNLESS OTHERWISE SPECIFIED				
DIMENSION IN INCHES		DATE	digital EQUIPMENT CORPORATION NAYARD, MASSACHUSETTS	
TOLERANCES		DATE		
DECIMALS FRACTIONS ANGLES		DATE		
= .005 ± 1/64 ± 0°30'		DATE		
FINAL SURFACE QUALITY		DATE	DYNAMIC X COUNTER (M-7000)	
REMOVE BURRS AND BREAK SHARP CORNERS		DATE		
MATERIAL		DATE	SIZE CODE NUMBER REV. DTD VT05-0-07	
NEXT HIGHER ASSY		DATE		
FINISH		DATE	SCALE OF 1 SHEET 1 OF 1	
		DATE		

SIZE CODE NUMBER REV.
DTD VT05-0-07

FIRST USED ON OPTION/ MODEL VT05		QTY.	DESCRIPTION	PART NO.	ITEM NO.
PARTS LIST					
UNLESS OTHERWISE SPECIFIED					
DIMENSION IN INCHES					
TOLERANCES					
DECIMALS FRACTIONS ANGLES					
= .005 = 1/64 = .030					
REMOVE BURNS AND BREAK SHARP CORNERS					
MATERIAL					
NEXT HIGHER ASSY					
A-ML-V-05-08					
FINISH		SCALE	SHEET	OF	1
UNLESS OTHERWISE SPECIFIED		DATE	PROJ. ENG.	DATE	PROJ. ENG.
UNLESS OTHERWISE SPECIFIED		DATE	PROJ. ENG.	DATE	PROJ. ENG.
UNLESS OTHERWISE SPECIFIED		DATE	PROJ. ENG.	DATE	PROJ. ENG.
UNLESS OTHERWISE SPECIFIED		DATE	PROJ. ENG.	DATE	PROJ. ENG.
UNLESS OTHERWISE SPECIFIED		DATE	PROJ. ENG.	DATE	PROJ. ENG.
UNLESS OTHERWISE SPECIFIED		DATE	PROJ. ENG.	DATE	PROJ. ENG.
UNLESS OTHERWISE SPECIFIED		DATE	PROJ. ENG.	DATE	PROJ. ENG.
UNLESS OTHERWISE SPECIFIED		DATE	PROJ. ENG.	DATE	PROJ. ENG.
UNLESS OTHERWISE SPECIFIED		DATE	PROJ. ENG.	DATE	PROJ. ENG.
UNLESS OTHERWISE SPECIFIED		DATE	PROJ. ENG.	DATE </tr	

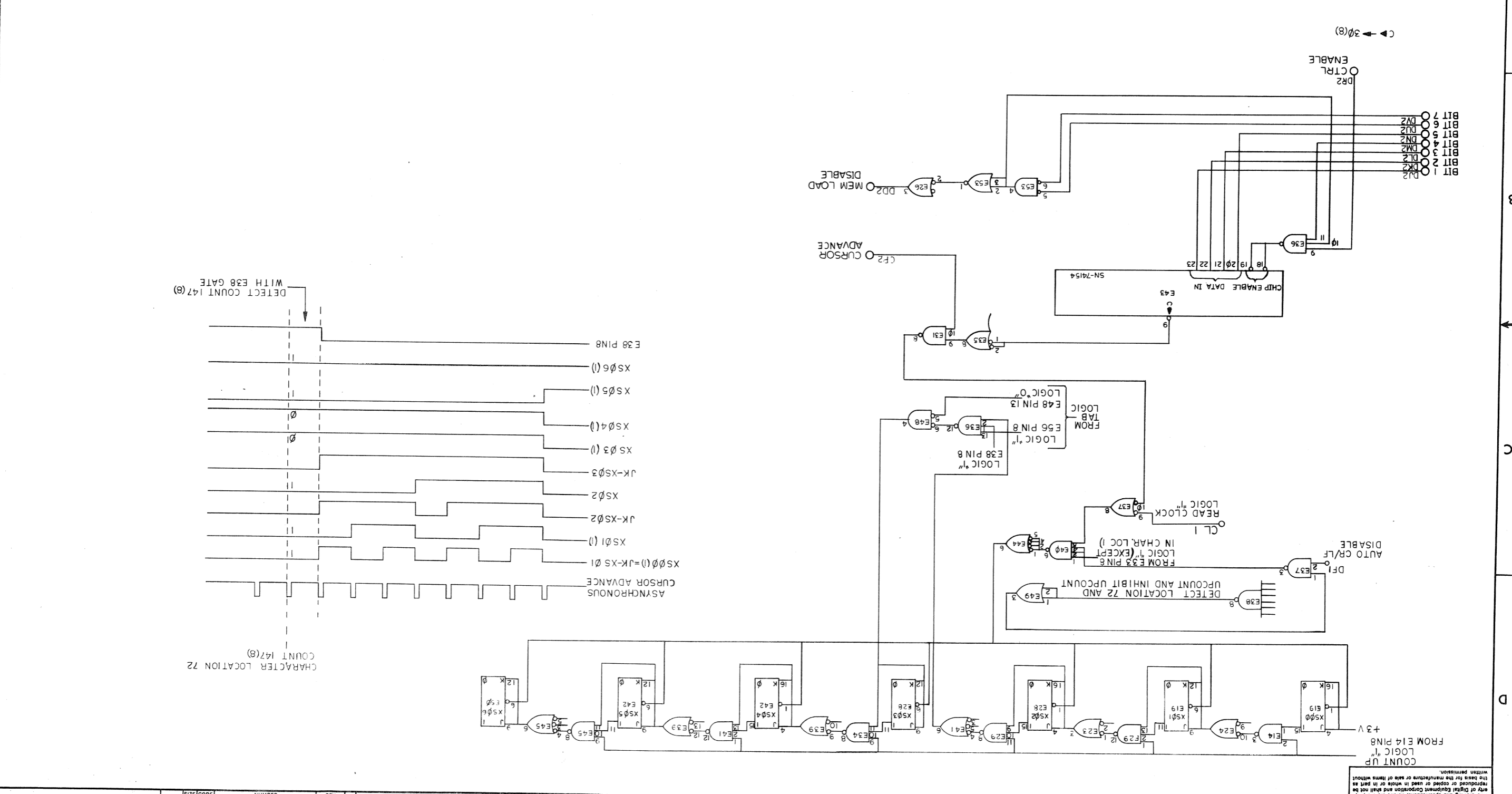

This drawing and specifications, herein, are the property of Digital Equipment Corporation and shall not be reproduced or copied or used in whole or in part as the basis for the manufacture or sale of items without written permission.

VT05-0-08

This drawing and specifications, herein, are the property of Digital Equipment Corporation and shall not be reproduced or copied or used in whole or in part as the basis for the manufacture or sale of items without written permission.

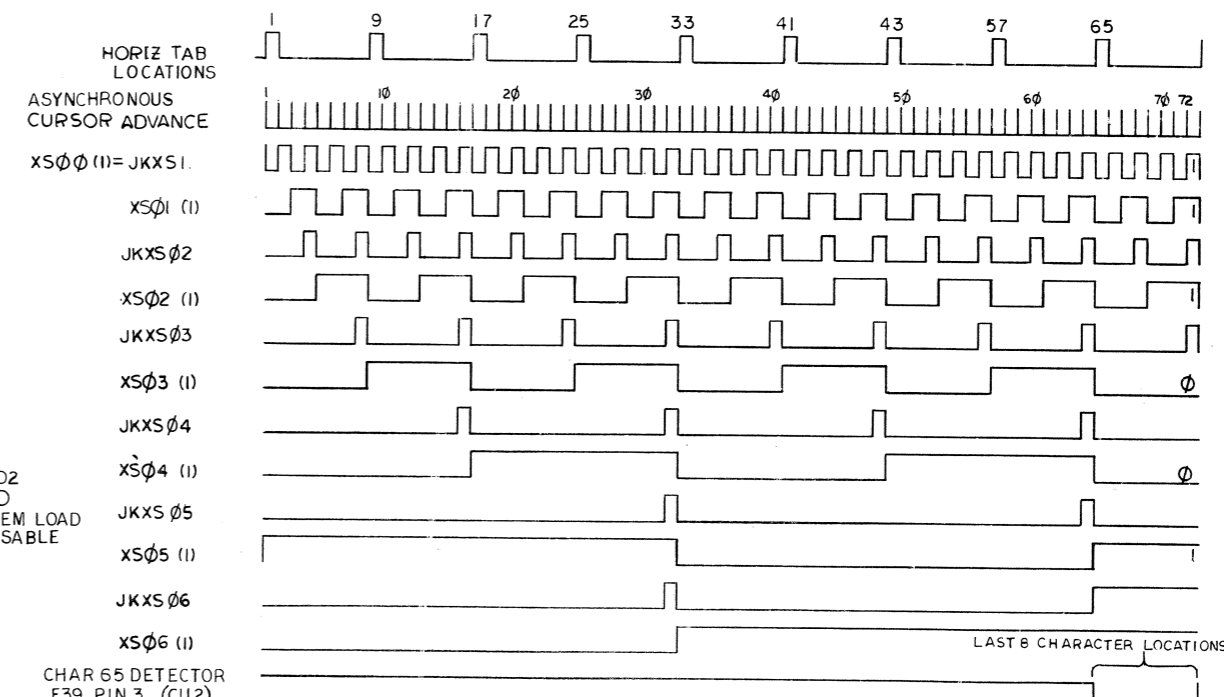
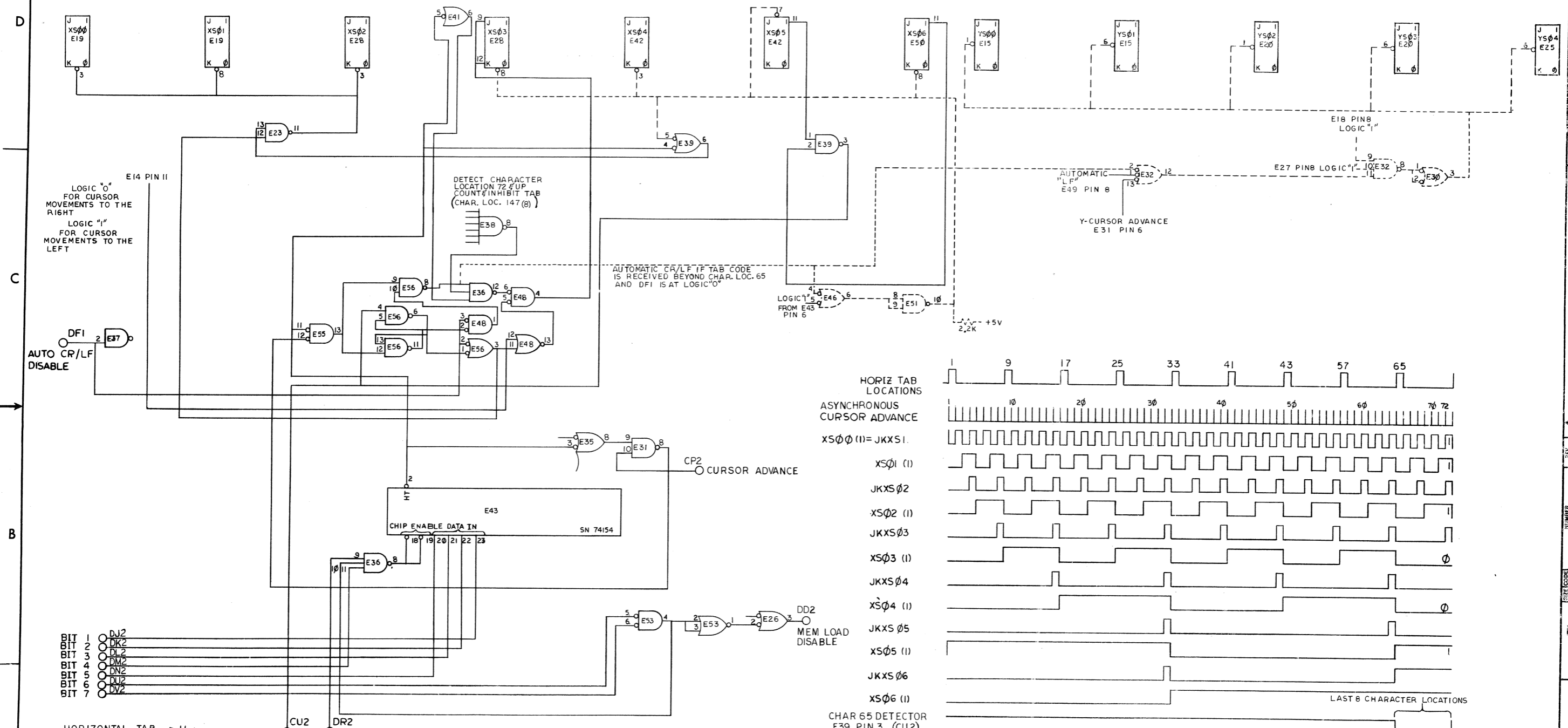

REV.	CHG.	NO.

FIRST USED ON OPTION/MODEL VT05	QTY.	DESCRIPTION	PART NO.	ITEM NO.
PARTS LIST				
UNLESS OTHERWISE SPECIFIED DIMENSION IN INCHES TOLERANCES DECIMALS FRACTIONS ANGLES ± .005 ± 1/64 ± 0°30' FINAL SURFACE QUALITY REMOVE BURRS AND BREAK SHARP CORNERS	DRN DATE 12/15/70	DATE 9/2/71	digital EQUIPMENT CORPORATION MAYNARD, MASSACHUSETTS	
	ENG DATE 6/16/71	DATE 6/16/71		
MATERIAL + + +	PROJ DATE 7/1/71	TITLE TAB LOGIC		
FINISH + + +	NEXT HIGHER ASSY A-ML-VT05-0		(M-7000)	
	SCALE SHEET 1 OF 1	SIZE/CODE DITDVT05-0-09		NUMBER REV.

This drawing and specifications, herein, are the property of Digital Equipment Corporation and shall not be reproduced or copied in whole or in part as the basis for the manufacture or sale of items without written permission.

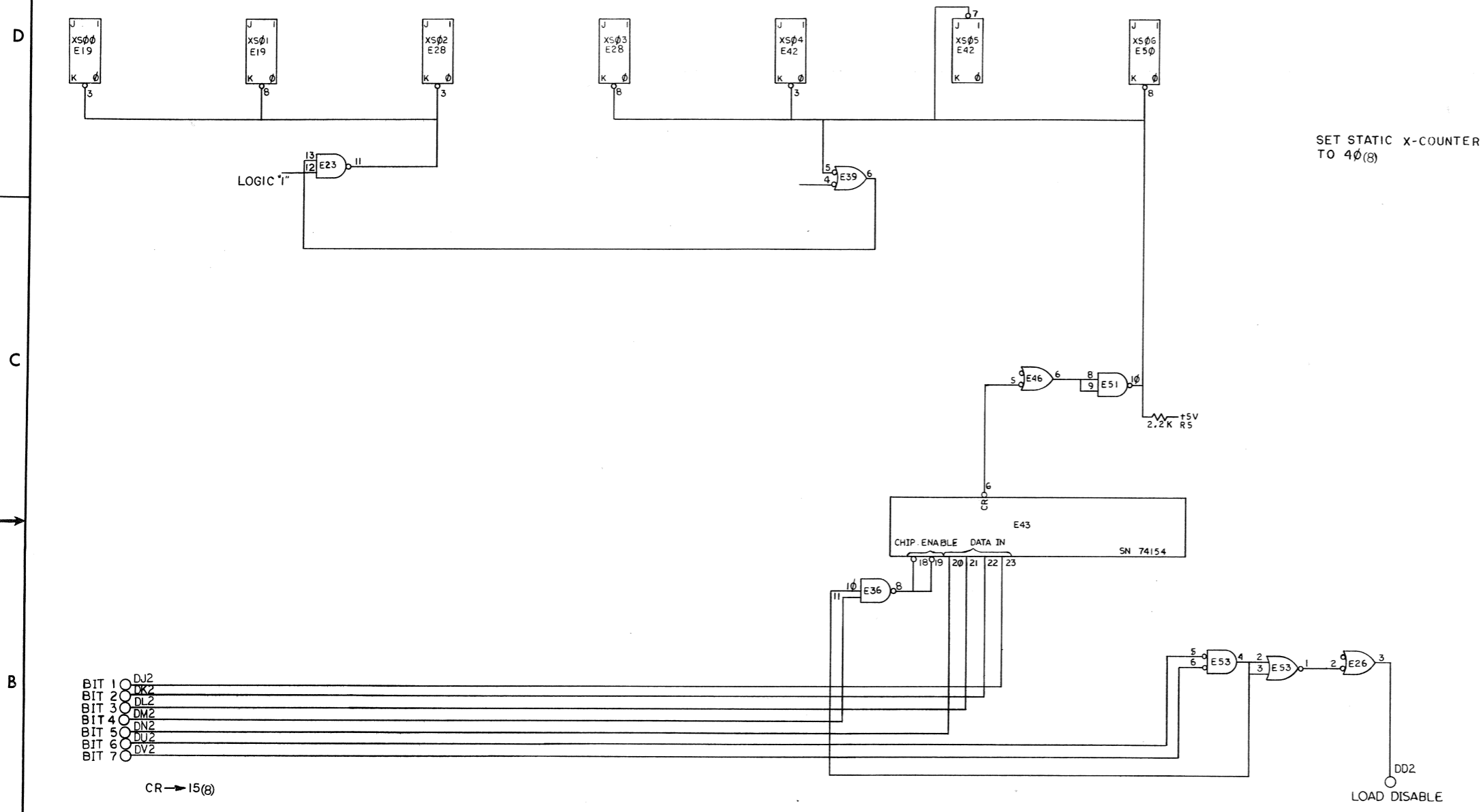

REV.	
CHG.	
CHK.	

FIRST USED ON OPTION/MODEL VT05	QTY.	DESCRIPTION	PART NO.	ITEM NO.
PARTS LIST				
UNLESS OTHERWISE SPECIFIED	DRN	DATE	digital EQUIPMENT CORPORATION MAYNARD, MASSACHUSETTS TITLE CARRIAGE RETURN (CR) (M-7000)	
UNLESS OTHERWISE SPECIFIED	CHK'D	DATE		
DIMENSION IN INCHES	ENG	DATE		
TOLERANCES	PROJ. ENG.	DATE		
DECIMALS FRACTIONS ANGLES	PROD.	DATE		
± .005 ± 1/64 ± 0°30'				
FINAL SURFACE QUALITY / REMOVE BURRS AND BREAK SHARP CORNERS				
MATERIAL	NEXT HIGHER ASSY		SIZE/CODE	NUMBER
FINISH	A-ML-VT05-0		DITD	VT05-0-11
SCALE	SHEET 1 OF 1		DIST.	

REV. 11-0-0017

This drawing and specifications, herein, are the property of Digital Equipment Corporation and shall not be reproduced or copied or used in whole or in part as the basis for the manufacture or sale of items without written permission.

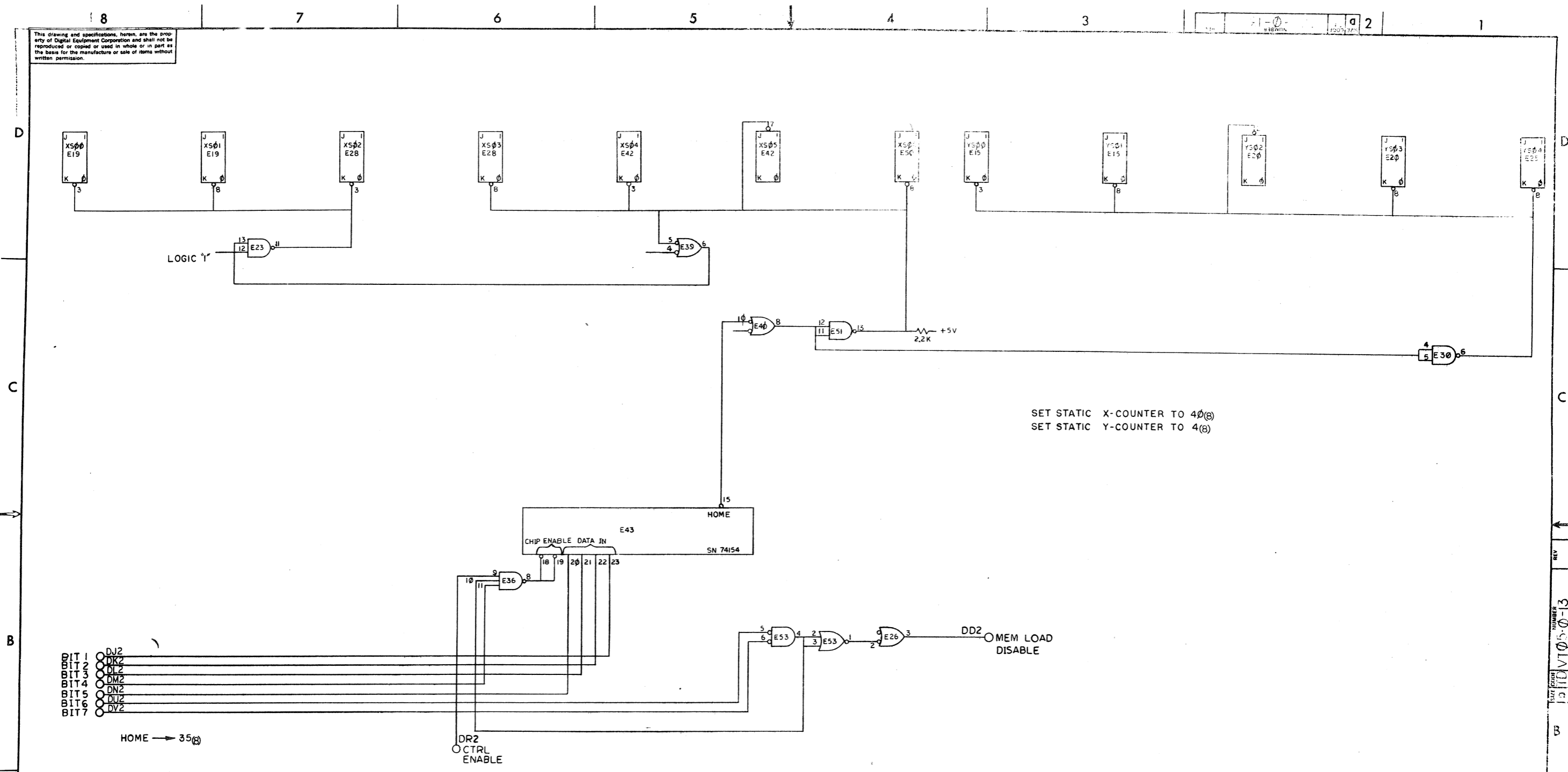

SET STATIC X-COUNTER TO 40(8)
SET STATIC Y-COUNTER TO 4(8)

BIT 1 ○ DJ2
BIT 2 ○ DK2
BIT 3 ○ DL2
BIT 4 ○ DM2
BIT 5 ○ DN2
BIT 6 ○ DU2
BIT 7 ○ DV2

HOME → 35(8)

DR2 CTRL ENABLE

REVISIONS	REV
CHANGE NO.	
CHK	

DEC FORM NO DRO 102A

FIRST USED ON OPTION MODEL VT05	QTY.	DESCRIPTION	PART NO	TEM NO
PARTS LIST				
UNLESS OTHERWISE SPECIFIED	DRM	DATE	digital EQUIPMENT CORPORATION	
UNLESS OTHERWISE SPECIFIED	CHK'D	DATE	MAYFAIR MASSACHUSETTS	
TOLERANCES	ENG	DATE	TITLE HOME	
DECIMALS FRACTIONS ANGLES	PROJ. ENGR	DATE		
FINAL SURFACE QUALITY	PROJ. ENGR	DATE	SIZE CODE NUMBER REV	
REMOVE BURRS AND BREAK SHARP CORNERS	PROJ. ENGR	DATE	DITDVT05 2-13	
MATERIAL	NEXT HIGHER ASSY		SCALE	
	A-ML-VT05-8		SHEET 1 OF 1	
FINISH			DIST.	

REV NUMBER 1310 VT05-0-13

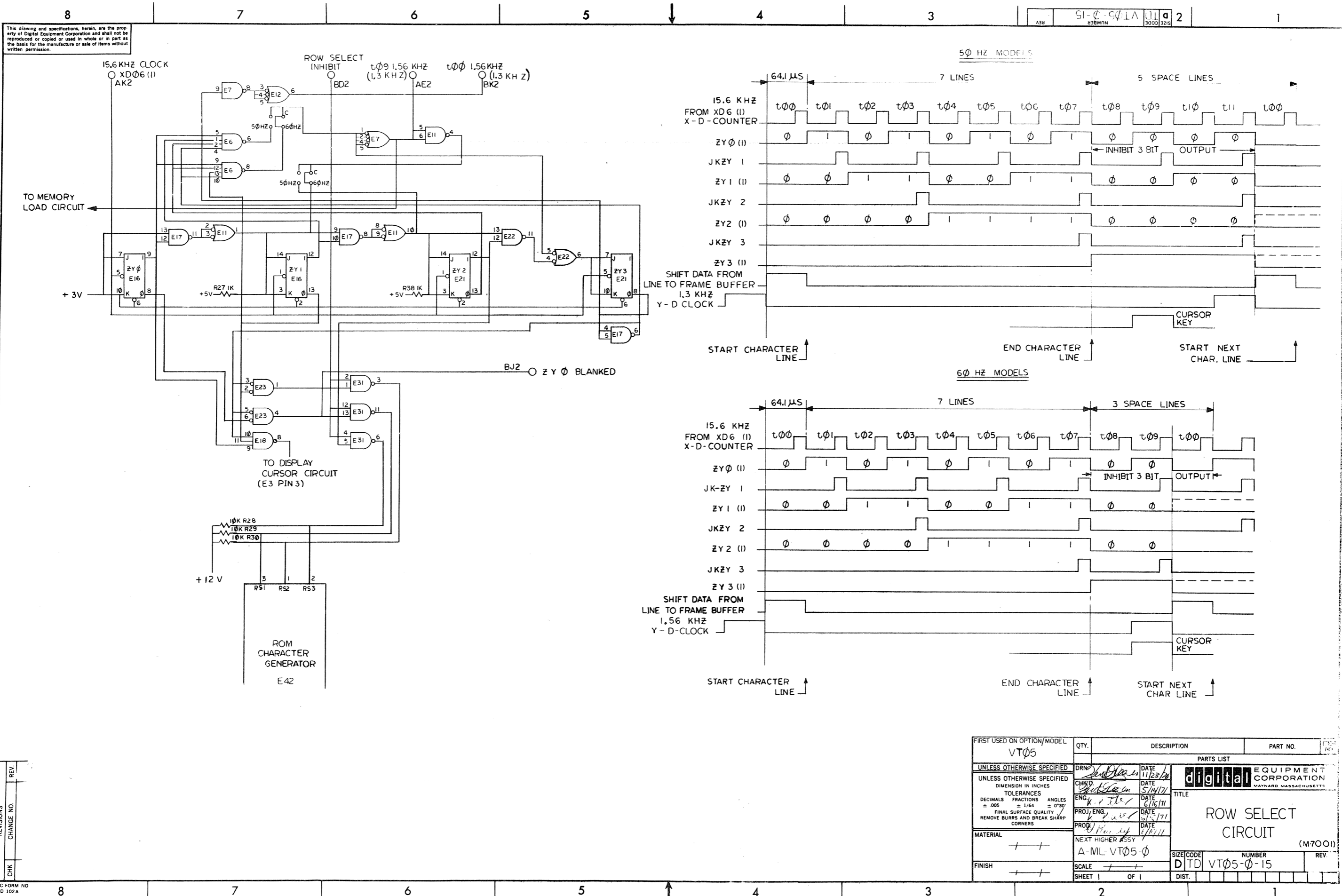

This drawing and specifications, herein, are the property of Digital Equipment Corporation and shall not be reproduced or copied or used in whole or in part as the basis for the manufacture or sale of items without written permission.

SI-C-501A (1) 2
 3300 (3216)

REV.	
CHANGE NO.	
CHK	

FIRST USED ON OPTION/MODEL VT05	QTY.	DESCRIPTION	PARTS LIST	PART NO.
UNLESS OTHERWISE SPECIFIED				
DRWG	DATE	PARTS LIST		
CHKD	DATE	digital EQUIPMENT CORPORATION MAYNARD, MASSACHUSETTS		
ENG.	DATE	TITLE		
PROJ. ENG.	DATE	ROW SELECT CIRCUI		
PROB.	DATE	(M7001)		
MATERIAL	NEXT HIGHER ASSY.	SIZE CODE	NUMBER	REV.
FINISH	SCALE	DITD	VT05-0-15	
	SHEET	OF		

DITD VT05-0-15

