

DIGITAL StorageWorks Installing a BA35X RETMA Shelf Mounting Kit

This document describes the procedure for installing a BA35X-RK RETMA shelf mounting kit into either the front or rear of a cabinet with RETMA mounting rails.

It also describes how to configure the mounting bracket to accommodate a variety of shelves.

Enclosure Mounting Kit

Upon unpacking the RETMA shelf mounting kit, use Table 1 to identify and inventory the parts.

NOTE

For easy identification, the DIGITAL part number is stamped on each part.





This kit is only for DIGITAL RETMA Cabinets.

To ensure adequate air circulation in the cabinet, a flushing fan (located at the top or top-rear of the cabinet) may be required.

Table 1 BA35X-RK RETMA Shelf Mounting Kit

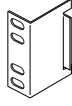
Description	Part Number	Qty
Mounting Bracket	74-47506-02	2
Stop Bracket	74-46440-01	2

Table 1 BA35X-RK RETMA Shelf Mounting Kit (Continued)

Description	Part Number	Qty
Front Locking Bracket	74-46441-01  CXO6270A	2
Front Locking Bracket	74-46441-02  CXO6269A	2
Front Locking Bracket	74-46441-03  CXO6247A	2
Rear Locking Bracket	74-46439-01  CXO6246A	2
Rear Locking Bracket	74-46439-02  CXO6244A	2
10-32 x 1/2 inch pan head SEMS screw	90-00063-39	2
M5 Keps Nut	90-40148-02	8

Configuration Options

Mounting bracket can be configured to receive shelves of varying depths. Table 2 provides specific shelf configuration for either the front or rear of the cabinet. Figure 1 illustrates the mounting bracket slots used to insert the stop bracket. Note that stop position 5 is a fixed position (part of the mounting bracket), therefore it doesn't require a stop bracket.

After identifying the type of shelf your installing, determine if it will be installed in the front or rear of the cabinet. Refer to Table 2 and note the type of locking bracket and the stop bracket stop position. This information is required to complete the installation procedure.

Figure 1 Identifying the RETMA Shelf Mounting Bracket Stop Position

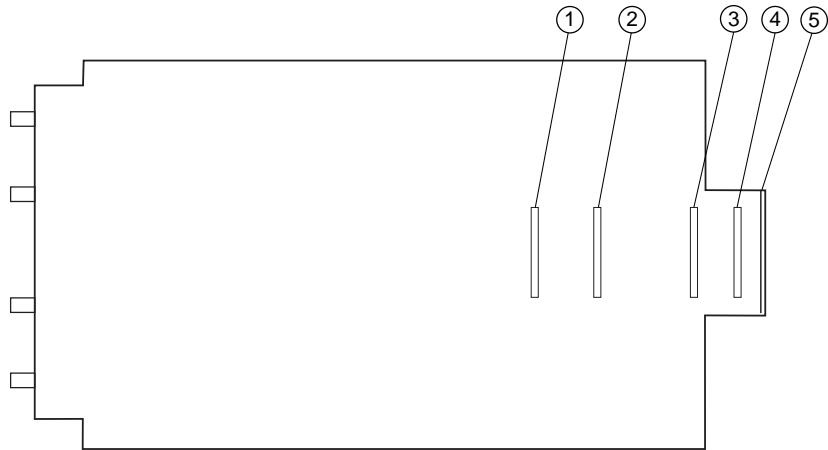

CXO6242A

Table 2 Shelf Bracket Configuration

Type of Shelf	Front		Rear	
	Stop Bracket Position	Locking Bracket Part Number	Stop Bracket Position	Locking Bracket Part Number
BA350-M Series Controller Shelf	5	74-46441-02	2	74-46439-02
BA350-S Series SBB Shelf	4	74-46441-01	1	74-46439-01
DS-BA356 M Series Controller Shelf	5	74-46441-02	4	74-46441-01
DS-BA356 S Series SBB Shelf	4	74-46441-01	1	74-46439-02

RETMA Shelf Installation

Complete the procedures in this section to install a shelf into a DIGITAL RETMA cabinet.

Preliminary Data

The height of this shelf is approximately 150 mm (5.9 inches).
 Shelves can be mounted in either the front or rear of the cabinet.
 Depending upon cabinet configuration, a flushing fan may be required to ensure adequate cooling.
 DIGITAL recommends that this shelf be mounted horizontally in the cabinets.

Shutdown the Subsystem

Remove all power from the cabinet.

WARNING

The possibility of injury exists due to the high voltages present within the cabinet when power is applied. Therefore, all components must be turned off. DIGITAL recommends that you disconnect the ac power cord from the wall receptacle.

Shelf Installation Procedure

WARNING

Do Not slide hands along cabinet rail edges. The rail edges are very sharp and may cause personal injury.

Depending upon where the shelf is to be installed (front or the rear of the cabinet), refer to Table 2 to find the appropriate stop bracket position and the type of locking bracket required. Complete Table 3 Procedure for installing the Shelf.

Table 3 Procedure for installing a RETMA Shelf

- 1 Install the stop bracket onto the mounting bracket as noted in Table 2.
- 2 Place the first mounting bracket behind the outer flange and against the inner flange of the cabinet vertical rail. Ensure the mounting studs and tabs are aligned with the vertical rail holes.

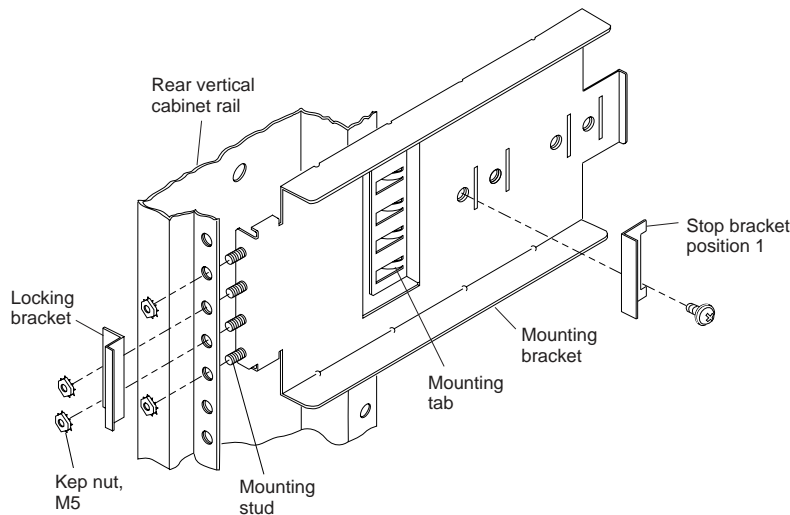

CXO6254A

Typical Mounting Assembly

3. Slide the mounting bracket forward to seat the studs and tabs.
4. Install an M5 Kep nut onto the top and bottom stud, fully tighten.
5. Repeat step 1 through 4.
6. Slide the shelf into the mounting brackets and fully seat it against the stop brackets. The front of the shelf should align with the rest of the shelves in the cabinet.
7. Position the appropriate locking bracket over the two middle studs and install two M5 Kep nuts, finger tighten.
8. Adjust the locking bracket so that the flange is firmly seated against the shelf.
9. Fully tighten the M5 Kep nuts installed in step 7.
10. Repeat step 6 through 9.