

digital

pdp**8/e** & pdp**8/m**
small computer
handbook

1972

digital equipment corporation

Copyright © 1971 by
Digital Equipment Corporation

The following are registered trademarks of Digital Equipment Corporation,
Maynard, Massachusetts:

DEC
FLIP CHIP
DIGITAL
DIBOL
OMNIBUS
DECmagtape

PDP
FOCAL
COMPUTER LAB
LAB8/e
DECTape

**USERS
THUMB
INDEX**

PDP-8/E STORY	
SYSTEM INTRODUCTION	
STANDARD SYSTEM OPERATION	
MEMORY & PROCESSOR INSTRUCTIONS	
PROGRAMMING & SYSTEM PROGRAMS	
PROGRAMMED DATA TRANSFERS	
DATA BREAK	
PDP-8/E OPTIONS	
DIGITAL LOGIC CIRCUITS	
OMNIBUS INTERFACE DESIGN	
I/O EXPANSION TECHNIQUES	
INSTALLATION & PLANNING	
CUSTOMER SERVICES	
PROGRAM ABSTRACTS	
PROGRAMS SUPPLIED/OPTION	
APPLICATIONS	

FOREWORD

Minicomputers, from Digital Equipment Corporation, are changing your world—in banks and hospitals, supermarkets and factories. Everywhere people are realizing that computers don't have to be large and expensive to get the job done. A Computer is no longer a multi-million dollar giant that can only survive in spotlessly clean rooms. Minicomputers are going where the job is, because they are rugged, dependable, and inexpensive.

You should know about minicomputers. The PDP-8/E Story shows our computers at work; designing, producing and testing new computers, saving time and money. Other industries, such as oil refineries and automobile manufacturers, are also using the power and speed of computers to produce better products. Minicomputers are not just for big business; hospitals, schools, laboratories and factories are using minis just as effectively. New and old companies are exploring minicomputers.

How large a computer should you buy? Most enterprises begin small, After the computer requirements are completely defined, a decision is then made to either continue with the existing system or to expand. The basic PDP-8/E can be expanded without having to sacrifice your initial investment.

Right now, there are more than 16,000 minicomputers serving in almost every field of endeavor and embracing every discipline known to man. The PDP-8/E and PDP-8/M are DEC's newest models of the PDP-8 family. We invite you to explore the advantages of owning this small machine with big ideas.

INTRODUCTION

This handbook is another in a series intended to familiarize the user with the Digital Equipment Corporation (DEC) PDP-8 family of small general-purpose computers. It explains the newest member of the family, the PDP-8/E Programmed Data Processor and how it is interfaced with the wide variety of peripheral equipment available.

Major topics are: The Programmed Data Processor, PDP-8/E Options, Interface & Installation, Support Services, and Appendices.

Another member of this series of handbooks is titled: An Introduction to Programming. The programming handbook familiarizes the user with the principles of programming the PDP-8 family of general-purpose computers. Together this handbook and the programming handbook describe the complete hardware and software aspects of the PDP-8 family. A newly released handbook called Programming Languages has been added to the handbook series which contains information on the primary languages for the PDP-8 family such as FOCAL, BASIC, PAL III, MACRO, PAL D, SABR, and 4K FORTRAN.

How to Use This Book

This book is neither a text book on computers nor a novel. It contains a wealth of information divided into specific areas of interest. For instance, Chapter 1 defines the basic processor and Chapter 3 defines the basic instructions. These two chapters offer information that allow the reader to compare a PDP-8/E with other processors.

A very important area to the reader who is buying a PDP-8/E is the extent of available, useable programs. Chapter 4 describes many of our commonly used programs, ranging from loaders to complete operating systems. Many more programs are further defined in Appendix A. However, these programs represent only a small fraction of the more than 1000 operating programs available to the PDP-8/E user.

Chapter 2 provides operating instructions. Because the operation of the processor requires similar steps, learning to operate the processor can be compared with learning to drive a car.

To add additional capability (such as peripherals) Chapter 7 defines the complete line of options. Thousands of these options are presently operating in customer facilities.

For the customer requiring a special application, Chapters 9 and 10 illustrate in detail how a customer can design an interface to allow the PDP-8/E or the PDP-8/M to control his particular application.

The PDP-8/E Computer requires operating and programming skills.

Chapter 12 explains our courses of instruction designed to qualify customers in the areas of operation, maintenance, and programming. Chapter 12 also defines other various types of services including maintenance, depot level repair, software support, application support, etc.

THE COMPANY

In a little over thirteen years, Digital has become a major force in the electronics industry. The company has grown from three employees and 8,500 square feet of production floor space in a converted woolen mill in Maynard, Massachusetts, to an international corporation employing more than 6,000 people with well over two million square feet of floor space in more than 60 manufacturing, sales, and service facilities around the world. In addition to the corporate headquarters in Maynard, Massachusetts, other manufacturing facilities are located in Westfield and Westminster, Massachusetts. Internationally and outside the continental United States, Digital has manufacturing plants in England, Canada and Puerto Rico.

From its beginnings as a manufacturer of digital modules, the company has now grown to the point where it is the world's largest manufacturing supplier of logic modules and the third largest computer-manufacturer, by number of installations, in the industry. Digital's rise as a leader in the electronics industry began in 1957 with the introduction of the company's line of electronic circuit modules. These solid-state modules were used to build and test other manufacturers' computers. Two years later, Digital introduced its first computer, the PDP-1. The PDP-1 heralded a new concept for the industry—the small, on-line computer. And the PDP-1 was inexpensive—it sold for \$120,000 while competitive machines with similar capabilities were selling at over \$1 million. But the PDP-1 was more than a data processor; more than just a tool to manipulate data. It was a system that could be connected to all types of instrumentation and equipment for on-line, real-time monitoring control, and analysis. It was a system with which people and machines could interact.

Also, in 1958, Digital introduced the Systems Modules, high-quality, low-cost, solid-state, digital logic circuits on a single printed circuit card.

Today, electronic modules like the ones Digital introduced are used in most electronic equipment, from computers to television sets.

In 1965, Digital announced the first of the FLIP CHIP® module lines. These highly reliable modules include cards for internal computer logic, interfacing, control and analog-to-digital conversion.

In 1963, Digital Equipment Corporation introduced the PDP-5 computer, predecessor of the PDP-8 series. This was followed by the first PDP-8/1, and PDP-8/L. Over this seven year period, considerable improvement has been made, many options have been developed, over 60 peripherals and a variety of programs developed. As each new application need arises, Digital Equipment engineering responds with new equipment; each time further increasing the capability of the PDP-8 Family and making available a wider range of equipment.

Throughout the life span of the PDP-8 Family, DEC has developed more than 1,000 programs for a wide variety of applications. New programs are constantly in development by Digital's Programming Department and the PDP-8 Users. This means that each PDP-8/E user will have a wide variety of programs immediately available to him.

To further enhance the user's capability, the DECUS library contains a wide variety of programs developed by the PDP-8 users. This library is operated by DEC exclusively for customer use. Programs are available for as little as \$1.00 each.

The PDP-8/E is designed for the inexperienced as well as the most sophisticated user. Digital Equipment Corporation provides training as well as maintenance.

PDP-8/E FEATURES

Digital's all new PDP-8/E is the most powerful, most expandable and most versatile 12-bit computer available today. Its low price and high performance makes it the ideal system for a variety of uses, extending all the way from minimal control units to fully expanded general purpose systems. It is fast, compact and easy to interface.

PDP-8/E offers features such as a unique internal bus system called OMNIBUS™, which allows the user to plug memory and processor options into any available slot location; the availability of 256 words of Read-Only or Read/Write memory; a 1.2 microsecond memory cycle time; the use of TTL integrated circuitry with MSI technology; expansion to 32,768 12-bit words of core storage; low-cost mass storage expansion with DECdisk or DECTape; and a space and money saving packaging design.

PDP-8/E Features at a Glance:

- A unique internal bus design called OMNIBUS which eliminates the need for back panel wiring. Processor options can be inserted in any available slot.
- Increased speed-memory cycle time of 1.2 microseconds.
- A new packaging scheme which makes PDP-8/E physically smaller than its predecessor, the PDP-8/1. And, with no predetermined locations needed for options, there is no wasted space in the logic panel.
- A full line of over 60 options and peripherals immediately available.
- More than 1000 programs immediately available to the user.
- Availability of 256 word increments of Read-Only memory and/or Read/Write memory.
- A Standard General Purpose register in the basic machine which becomes the MQ register when the EAE option is implemented.
- Six additional Processor IOT instructions which make flag manipulation and interrogation faster and easier.

- A six bit byte swap instruction allowing faster and more convenient character handling.
- TTL integrated circuit modules utilizing MSI technology.
- Over 11,000 compatible PDP-8 Family computers in use for sharing programs through Digital's users group, DECUS.
- Low-cost core memory expansion to 32,768 words and low-cost mass storage expansion with DECdisk, DECtape and IBM-compatible magnetic tape.
- Hardware Bootstrap Loader option.
- Provision for multiple (up to 17 total) teletypes.
- Worldwide, dependable service.
- Program and maintenance training included.
- Fully parallel processor.
- Link feature to facilitate multiple precision arithmetic.
- Full range of turnkey and applications-oriented systems available.
- Over seven years of software development by Digital.
- Expanded hardware multiply/divide.
- Eight auto-index registers.
- **FO**rmula **CA**lculator Language (FOCAL)
- **D**igital Equipment Corporation
Business **O**riented Language (DIBOL)
- FORTRAN
- BASIC
- Assemblers
- Editors
- Debugging Aids
- Operating Systems

CONTENTS

PART I BASIC SYSTEM

CHAPTER 1 SYSTEM INTRODUCTION

SECTION 1 THE PDP-8/E BASIC SYSTEM	1-1
SECTION 2 THE PDP-8/M OEM PROCESSOR	1-2
SECTION 3 COMPUTER ORGANIZATION	1-4
MAJOR REGISTERS (M8300)	1-6
Accumulator (AC)	1-6
Multiplier Quotient (MQ) Register	1-6
Program Counter (PC)	1-6
Central Processor Memory Address (CPMA) Register	1-6
Memory Buffer (MB) Register	1-6
Data Gates and Adders	1-7
REGISTER CONTROLS (M8310)	1-7
Link (L)	1-7
Major Register Control Circuits	1-7
Major State Register	1-7
Instruction Register (IR)	1-7
BUS LOADS (M8320)	1-8
TIMING GENERATOR (M8330)	1-8
PROGRAMMERS CONSOLE	1-9
TELETYPE CONTROL (M8350)	1-9
PDP-8/E MEMORY SYSTEM (MM8-E)	1-9
The XY Driver & Current Source	1-9
Memory Stack (H220)	1-10
Sense/Inhibit Module (G104)	1-10
MAJOR PROCESSOR STATES	1-10
Fetch (F) State	1-10
Defer (D)	1-11
Execute (E)	1-11
INTERFACING	1-12
DIFFERENCES BETWEEN PDP-8/E AND ITS PREDECESSORS	1-12
TTY Differences	1-13
External I/O Bus	1-13
EAE	1-13
Data Break	1-13
Control Panel	1-14
ADDRESSING NONEXISTING CORE	1-14

CHAPTER 2 STANDARD SYSTEM OPERATION

CONTROLS AND INDICATORS	2-1
KEYBOARD OPERATION	2-6
PRINTER OPERATION	2-7
PAPER TAPE PUNCH OPERATION	2-8
Paper Tape Formats	2-9
Paper Tape Loader Programs	2-11
OPERATING PROCEDURES	2-11
Manual Data Storage and Modification	2-12
Power For Manual Operation	2-12
Memory Addressing for Manual Operation	2-12
Manual Data Input To Addressed Memory Location	2-12
Checking the Contents of Any Address in Core	2-12
LOADING DATA UNDER PROGRAM CONTROL	2-12
INITIALIZING THE SYSTEM	2-13
PROGRAM LOADING OPERATION	2-13
Loaders	2-14
READ-IN-MODE (RIM) LOADER	2-14
BINARY (BIN) LOADER	2-17
SYMBOLIC EDITOR	2-20
WRITING A PROGRAM	2-21
GENERATING A PROGRAM TAPE	2-23
SEARCH FEATURE	2-25
ERROR DETECTION	2-26
SUMMARY OF SPECIAL KEYS AND COMMANDS	2-26
PAL III SYMBOLIC ASSEMBLER	2-28
ASSEMBLING A SYMBOLIC PROGRAM	2-29
Program Control	2-33

CHAPTER 3 MEMORY AND PROCESSOR INSTRUCTIONS

MEMORY REFERENCE INSTRUCTIONS	3-3
HOUSEKEEPING INSTRUCTION	3-4
AUGMENTED INSTRUCTIONS	3-5
OPERATE INSTRUCTIONS	3-5
Group 1	3-5
Group 2	3-8
Group 3	3-10

INPUT/OUTPUT TRANSFER (IOT)	3-12
PROGRAM INTERRUPT	3-13
INSTRUCTION SUMMARY	3-15
CHAPTER 4 MEMORY AND PROCESSOR BASIC PROGRAMMING	
GENERAL	4-1
SECTION 1 PDP-8/E PROGRAMMING FUNDAMENTALS	4-1
MEMORY ADDRESSING	4-1
INDIRECT ADDRESSING	4-5
PROGRAMMING OPERATIONS	4-8
STORING AND LOADING	4-8
ARITHMETIC OPERATIONS	4-10
Two's Complement Arithmetic	4-10
LOGIC OPERATIONS	4-11
Logical AND	4-11
Inclusive OR	4-12
Exclusive OR	4-12
INDEXING OPERATIONS	4-13
CODING A PROGRAM	4-15
Location Assignment	4-15
WRITING SUBROUTINES	4-16
ADDRESS MODIFICATION	4-18
LOOPING A PROGRAM	4-19
AUTO-INDEXING	4-22
PROGRAM DELAYS	4-23
PROGRAM BRANCHING	4-23
MICROPROGRAMMING	4-25
Combining Microinstructions	4-25
Illegal Combinations	4-25
Combining Skip Microinstructions	4-27
OR GROUP—SMA OR SZA OR SNL	4-27
AND GROUP—SPA AND SNA AND SZL	4-27
Group 1	4-28
Group 2	4-28
SECTION 2 PDP-8/E SYSTEM PROGRAMS	4-31
PDP-8/E Software Kit	4-31
System Programs	4-32
Monitor Programs	4-32
PS/8 Programming System	4-32

Disk Monitor System	4-32
Time Share Monitor (TSE)	4-32
Editor Program	4-34
Symbolic Paper Tape Editor	4-34
ASSEMBLER PROGRAMS	4-34
PAL III	4-34
PAL-D	4-35
PAL-8	4-35
MACRO-8	4-35
8K SABR	4-35
COMPILER PROGRAMS	4-36
DIBOL Software System	4-36
4K FORTRAN	4-36
8K FORTRAN COMPILER	4-36
INTERPRETIVE PROGRAMS	4-37
FOCAL-8	4-37
BASIC-8	4-37
DEBUGGER PROGRAMS	4-37
DDT-8	4-37
ODT-8	4-38
LOADERS	4-38
Binary Loader	4-38
Linking Loader	4-38
UTILITY PROGRAMS	4-39
Octal Memory Dump	4-39
Mathematical Function Routines	4-39
Floating Point Pack	4-39
MAINTENANCE AND DIAGNOSTIC PROGRAMS	4-40
THE DECUS LIBRARY	
APPLICATION PROGRAMS	
LAB8/E System Software	
INDAC Software for INDACS-8 System	4-42
EDUSYSTEMS 10 THROUGH 50	4-45
EDUSYSTEM 10	4-47
EDUSYSTEM 20	4-48
EDUSYSTEM 30	4-49
EDUSYSTEM 40	4-50
EDUSYSTEM 50	4-51
 CHAPTER 5 PROGRAMMED DATA TRANSFER	
GENERAL	5-1
PROGRAMMED DATA TRANSFER VS. DATA BREAK	5-1
PERIPHERAL REQUIREMENTS	5-1

PRINCIPLES OF PROGRAMMED I/O TRANSFERS	5-2
The IOT Instruction	5-2
Flags	5-3
Data Transfers	5-4
PRINCIPLES OF PROGRAM INTERRUPTS	5-5
General	5-5
The Interrupt Subroutine	5-6
The Flag-Testing and Restoration Subroutine	5-6
The Reader Service Routine	5-7
The Punch Service Routine	5-7
CHAPTER 6 DATA BREAK	
GENERAL	6-1
THE BASIC DATA BREAK SYSTEM	6-1
Current Address (CA) Register	6-2
Word Count (WC) Register	6-2
Data Break Priority	6-2
Data Register	6-2
Data Break Configurations	6-3
ONE-CYCLE DATA BREAK TRANSFERS	6-3
Initial Set-up	6-3
Data Transfer	6-7
Exit	6-7
THREE-CYCLE DATA BREAK TRANSFERS	6-7
Initial Set-up	6-7
Word Count	6-7
Current Address	6-7
Data Transfer	6-10
Exit	6-11
PROGRAMMING EXAMPLE	6-11
BLOCK TRANSFER SUBROUTINE	6-11

PART II PDP-8/E OPTIONS

CHAPTER 7 PDP-8/E OPTIONS

SECTION 1 MECHANICAL EXPANSION OPTIONS	7-1
SYSTEM EXPANDER BOXES	7-1
Type BA8-AA System Expander Box	7-1
Type BA8-AB System Expander Box	7-1
Type BE8-A OMNIBUS Expander	7-1
PANEL OPTIONS	7-1
Type KC8-EC Turn-Key Front Panel	7-1
Type KC8-EB Blank Front Panel	7-1

SECTION 2 COMPUTER INTERNAL OPTIONS	7-4
Type KE8-E Extended Arithmetic Element	7-4
Programming	7-4
MEMORY EQUIPMENT OPTIONS	7-14
KM8-E Memory Extension and Time Share Option	7-14
Memory Extension Description	7-14
Programming	7-15
Time-Share Description	7-20
MP8-E Memory Parity	7-21
Programming	7-22
MW8-E 256-Word Read/Write Memory	7-23
MR8-EA 256-Word Read-Only-Memory	7-24
MR8-EB 1024-Word Read-Only-Memory	7-24
MI8-E Bootstrap Loader	7-24
REAL TIME CLOCK OPTIONS	7-25
Type DK8-EA Real Time Clock (Line Frequency)	7-25
Programming	7-25
Type DK8-EC Real Time Clock (crystal)	7-25
Type DK8-EP Programmable Real Time Clock	7-26
Programming	7-26
TYPE KP8-E POWER FAIL DETECT	7-26
Programming	7-31
SECTION 3 OMNIBUS INPUT/OUTPUT EQUIPMENT OPTIONS	7-35
CONSOLE TELEPRINTERS	7-35
LC8-E DECwriter Control	7-35
Keyboard	7-35
Printer	7-37
LA30 Differences from Teletype	7-38
LA30 DECwriter	7-39
Model ASR33 Teletype	7-40
PAPER TAPE READER AND PUNCH OPTIONS	7-41
PR8-E Paper Tape Reader	7-41
Programming	7-41
PDP8-E Paper Tape Punch	7-42
Programming	7-42
PC8-E Reader/Punch	7-43
Programming	7-43
CRT DISPLAYS	7-44
Point Plot Display System	7-44
Type VR14 Oscilloscope Display	7-45
VC8-E Point Plot Display Control	7-45
Programming	7-47
VT05 Alphanumeric Display Terminal	7-52
Applications	7-53
X/Y PLOTTER OPTIONS	7-54
XY8/E Incremental Plotter Control	7-54
Programming	7-58

XY8-EA Digital Incremental Plotter	7-60
XY8-EB Digital Incremental Plotter	7-60
XY8-EH, EJ, EK Digital Incremental Flatbed Plotter	7-60
LINE PRINTER OPTION	7-62
LE8 Line Printer	7-62
Programming	7-66
DATA COMMUNICATIONS EQUIPMENT OPTIONS	7-68
DP8-EA and DP8-EB Synchronous Modem Interface	7-68
Programming	7-73
DP8-EP Redundancy Check Option	7-83
Programming	7-84
KL8-E Asynchronous Data Control	7-87
Keyboard/Reader	7-87
Programming	7-88
Teleprinter/Punch	7-89
Programming	7-90
Asynchronous Data Controls KL8-EA through KL8-EG	7-92
CARD READ OPTIONS	7-94
CR8-E Card Reader and Control	7-94
Programming	7-95
CM8-E Optical Mark Card Reader and Control	7-99
Programming	7-99
OMNIBUS MAGNETIC TAPE OPTIONS	7-101
DECTapes	7-101
TD8-E DECTape Option	7-101
TD8-E DECTape Control	7-101
TU10 DECmagnetic Tapes	7-103
OMNIBUS DECmagtape Unit and Control	
Type TM8-E/F	7-106
Programming	7-106
TU10 MASTER	7-114
TU10 SLAVE	7-114
LABORATORY PERIPHERALS	7-117
AD8-EA Analog-to-Digital Converter	7-117
Programming	7-117
AM8-E 8-Channel Analog Multiplexer	7-122
DR8-EA 12-Channel Buffered Digital I/O	7-124
Programming	7-126
Laboratory Peripheral Panel	7-129
DB8-E INTERPROCESSOR BUFFER	7-131
SECTION 4 EXTERNAL BUS INPUT/OUTPUT EQUIPMENT	
OPTIONS	7-134
EXTERNAL BUS INTERFACE CONTROL OPTIONS	7-134
KE8-E Positive I/O Bus Interface	7-134
BBO8-P General Purpose Interface Unit	7-134
Programming	7-135
KD8-E Data Break Interface	7-137

RANDOM ACCESS DISK DEVICES	7-138
RK8 Disk System	7-138
RK01 Disk Drive and Control	7-140
RK08-P Disk Interface Control	7-141
Programming	7-142
DF32-D DEC Disk File and Control and DS32-D DEC	
Disk File Expander	7-147
Programming	7-148
Type RFO8 Disk File and Control and Type RS08 Expander	
Disk File	7-151
Programming	7-153
MAGNETIC TAPE OPTIONS	7-160
DEctape	7-160
DEctape Format	7-161
TU56 Dual DEctape Transport and	
TC08-P DEctape Control	7-167
TC08-P DEctape Control	7-169
Programming	7-174
Software	7-178
EXTERNAL BUS MAGNETIC TAPE OPTIONS	7-180
TC58 DECmagtape System	7-182
Programming	7-182
Magnetic Tape Functions	7-186
DATA ACQUISITION PERIPHERALS	7-192
ADO1-A 10 (or 11)—Bit Analog-to-Digital Converter	7-192
Programming	7-194
AFC8 Low-Level Analog Input Subsystem	7-195
Programming	7-197
AFO4-A Guarded Scanning Integrating Digital Voltmeter	7-198
Programming	7-199
Additional AFO4-A Options	7-204
AA50-A Digital-to-Analog Conversion Subsystem	7-204
Programming	7-205
AA05-A/AA07 Digital-to-Analog Converter and Control	7-205
Programming	7-207
Universal Digital Controller (UDC)	7-207
VWO1 WRITING TABLET	7-211
Programming	7-214
POSITIVE I/O BUS DATA COMMUNICATIONS EQUIPMENT	
OPTIONS	7-219
DCO2-F 8-Channel Multiple Teletype Control	7-219
Programming	7-223
DCO2-G Serial Line Interface Unit	7-224
FLOATING POINT PROCESSOR TYPE FPP-12	7-225
Floating Point Number System	7-225
Instruction Set	7-230
RTO1 DEC-link® Data Entry Terminal	7-237
Programming	7-238
DWO8-A I/O CONVERSION PANEL	7-239

PART III INTERFACING & INSTALLATION

CHAPTER 8 DIGITAL LOGIC CIRCUITS

INTRODUCTION	8-1
LOGIC SYMBOLS	8-1
State Indicator	8-1
Table of Combinations	8-3
One-Shot Functions	8-4
Schmitt Trigger	8-4
General Logic Symbols	8-5
Amplifier	8-5
Time Delay	8-6

CHAPTER 9 THE OMNIBUS INTERFACING

INTRODUCTION	9-1
SECTION 1 OMNIBUS DESCRIPTION	9-3
BUS STRUCTURE	9-3
BUS SPECIFICATIONS	9-4
SYSTEMS CONFIGURATION	9-4
RELATIONSHIP OF THE EXTERNAL BUS TO THE OMNIBUS	9-6
OMNIBUS SIGNALS	9-6
SECTION 2 HOW TO CHOOSE THE TYPE OF I/O TRANSFER	9-29
DATA TRANSFER TYPES	9-29
INTERFACING TO THE PROCESSOR	9-29
DATA TRANSFER RATES	9-32
DEVICE CODES	9-32
SECTION 3 DESIGNING BASIC PROGRAMMED I/O INTERFACE	
CONTROL CIRCUITS	9-34
DEVICE SELECTION CIRCUIT	9-34
OPERATIONS DECODER	9-34
FLAG LOGIC	9-36
INTERRUPT REQUEST	9-36
OUTPUT BUFFER	9-36
INPUT BUFFER	9-36
I/O CONTROL	9-39
INPUT/OUTPUT TIMING FOR PROGRAMMED I/O INTERFACES	9-39

SECTION 4 DESIGNING A BASIC DATA BREAK INTERFACE	9-41
BREAK ADDRESS	9-42
DATA PATHS	9-42
STATUS REGISTER	9-42
BREAK PRIORITIES	9-42
TRANSFER DIRECTION AND LOADING LOGIC	9-42
DATA BREAK INTERNAL LOGIC AND TIMING	9-42
BASIC ONE-CYCLE DATA BREAK INTERFACE	9-43
TIMING FOR SAMPLE DATA BREAK INTERFACE	9-47
THREE-CYCLE DATA BREAKS	9-47
DESIGN CHECK LIST FOR SINGLE CYCLE DATA BREAK INTERFACE	9-51
SECTION 5 GENERAL DESIGN AND CONSTRUCTION GUIDELINES	9-52
INTERFACE DESIGN OPTIONS	9-52
ETCHED CIRCUIT LAYOUT AND CONSTRUCTION RULES	9-52
GENERAL CABLE RULES AND SUGGESTIONS	9-54
DEC SUPPLIED INTERFACE CABLES	9-54
CABLING RULES	9-54
INTERFACE TIMING CRITERIA	9-56
General Timing Rules	9-56
Interrupt Timing	9-56
Timing Example	9-56
Timing Requirements For Data Break Facilities	9-58
Timing and Break Priorities	9-58
GENERAL PROPAGATION DELAY GUIDELINES	9-58
2-input NAND Gate Delay	9-59
Flip-Flop Propagation Delays	9-59
J-K Flip-Flops	9-60
One-Shot Delays	9-60
MAXIMUM OPERATING FREQUENCY	9-60
LOADING RULES	9-62
Device Selection Inputs	9-63
Skip and Interrupt Request Lines	9-63
Electrical Considerations of Driving a Line	9-63
GROUNDING	9-63

TESTING TECHNIQUES	9-63
Initial Checkout	9-63
System Test	9-63
Final Testing	9-64
PROGRAMMING RULES	9-64
DESIGN CHECKLIST	9-64
SECTION 6 PDP-8/E INTERFACE HARDWARE	9-66
W966 & W967 MOUNTING BOARDS	9-67
H851 EDGE CONNECTOR	9-68
MODULE HOLDERS	9-68
30-GAUGE INSULATED WIRE	9-68
CHAPTER 10 I/O EXPANSION TECHNIQUES	
SECTION 1 POSITIVE I/O BUS INTERFACING TECHNIQUES	10-1
THE NATURE OF THE EXTERNAL BUS	10-2
EXTERNAL BUS SIGNALS	10-3
APPLICATION	10-8
Programmed I/O Transfer	10-8
Program Interrupt Transfers	10-13
Data Break Transfers	10-13
INTERFACING TECHNIQUES	10-17
PDP-8/I and 8L-Type Peripherals	10-18
Customer Peripherals	10-20
DEC Logic Module Interfacing	10-20
Customer Designed Interfaces	10-28
Restrictions and Criteria	10-30
Cooling	
Signal Terminating	
Timing Criteria	
CABLING RULES AND SUGGESTIONS	10-31
SECTION 2 OMNIBUS INTERFACING USING "OFF THE SHELF" MODULES	10-34
OMNIBUS SIGNAL SUMMARY	10-34
THE BUILDING BLOCK APPROACH	10-34
M783 BUS DRIVERS	10-34
M784 BUS RECEIVERS	10-36
M785 BUS TRANSCEIVER	10-37
H9190 M935 KIT	10-38

H803 CONNECTOR BLOCK	10-38
M935 BUS CONNECTOR	10-39
H9190 MOUNTING PANEL	10-39
H019 MOUNTING BAR	10-40
INTERFACE EXAMPLE PAPER TAPE READER	10-42
INPUT/OUTPUT TRANSFER (IOT) INSTRUCTION USAGE	10-42
SYSTEM OPERATION	10-42
M-SERIES MODULE SUMMARY	10-43
K-SERIES MODULE SUMMARY	10-50

CHAPTER 11 INSTALLATION AND PLANNING

SPACE REQUIREMENTS	11-1
ENVIRONMENTAL REQUIREMENTS	11-5
INSTALLATION PROCEDURE	11-6
GROUNDING AND FACILITY POWER TESTS	11-12
SYSTEM CONFIGURATIONS	11-13
PDP-8/M PHYSICAL DIMENSIONS AND CHASSIS LAYOUT	11-14

PART IV DEC SERVICES

CHAPTER 12 EQUIPMENT SUPPORT SERVICES

INTRODUCTION	12-1
SECTION 1 MAINTENANCE AND SERVICE OPTIONS	12-1
Service Contracts	12-1
Service Contract Options	12-1
Eligibility for Service Contract Coverage	12-2
Depot Repair	12-2
FIELD INSTALLATION OF ADDITIONAL DEC OPTIONS	12-2
EXPANDED FIELD SERVICE COVERAGE FOR OEM'S	12-2
SECTION 2 THE DEC TRAINING PROGRAM	12-2
Course Offerings	12-3
Course Objectives	12-3
Hardware Familiarization Courses	12-3
PDP-8/1-8/L or 8/E Hardware Familiarization Course	12-3
PDP-8/1-8/L Systems Maintenance Course	12-3
LAB8/E Hardware Course	12-3
PDP-8/E Systems Maintenance Course	12-4
TC08-TU56 Hardware Course	12-4

SOFTWARE COURSES	12-4
Introductory Programming Course	12-4
PDP-8 Family Software Course (Paper Tape)	12-4
PDP-8 Family Software Course (PS-8)	12-4
PDP-8 Family Software Course (4K Monitor)	12-5
INDAC-8 Course	12-5
SECTION 3 TECHNICAL MANUAL SERVICE FOR OEM'S	12-5
SECTION 4 APPLICATION SUPPORT	12-5
SECTION 5 SOFTWARE SUPPORT	12-6
SECTION 6 ECO SERVICE	12-7
SECTION 7 CUSTOM PROGRAMMED READ ONLY MEMORY	12-7

APPENDIX A PROGRAM ABSTRACTS

SECTION 1 PROGRAM ABSTRACTS	A-1
System Programs	A-1
Monitor Programs	A-1
PS-8 Programming System	A-1
Disk Monitor System	A-2
TSE Time-Sharing Monitor	A-2
Editor Programs	A-3
Symbolic Editor	A-3
Assembler Programs	A-3
8K SABR Assembler	A-3
PAL III Assembler	A-4
MACRO-8 Assembler	A-4
PAL-D Disk Assembler	A-4
Compiler Programs	A-4
4K FORTRAN	A-4
8K FORTRAN	A-5
DIBOL Software System	A-5
Interpretive Programs	A-6
Basic 8	A-6
Basic	A-6
Debugging Programs	A-6
DDT-8	A-6
ODT-8	A-7
Loader Programs	A-7
Binary Loader	A-7
RIM Loader	A-7
Bootstraps	A-7
Utility Programs	A-7
Math Routine Manual	A-7
Read-in-Mode (RIM) Punch	A-8
Multianalyzer Display and Analysis	A-8

Variable Stroke Character Generator for KV8	A-8
Octal Memory Dump	A-9
Floating Point Package	A-9
Binary Punch	A-9
BCD to Binary Conversion	A-9
Double Precision BCD to Binary Conversion	A-10
Binary to BCD Conversion (4 digits)	A-10
Master Tape Duplicator	A-10
Alphanumeric Message Timeout	A-10
Teletype Output Subroutines	A-10
Character String Timeout	A-10
Symbolic Tape Format Generator	A-11
Signed Decimal Print—Single Precision	A-11
Unsigned Decimal Print—Double Precision	A-11
Single Precision Decimal to Binary Conversion and Timeout ASR33, Signed or Unsigned	A-11
DECtape Software	A-12
DECTape Programming Manual	A-12
DECTape Copy Routine	A-12
Maintenance Programs	A-12
Instruction Test Part I	A-12
Instruction Test Part II	A-13
8E Adder Test	A-13
Random AND Test	A-13
Random TAD Test	A-13
Random ISZ Test	A-13
Random DCA Test	A-13
Random JMP Test	A-13
Basic JMP-JMS Test	A-13
Random JMP-JMS Test	A-13
Power Fail Test	A-14
PDP-8E JMP SELF Test	A-14
Memory Checkerboard (Basic)	A-14
Extended Memory Checkerboard	A-14
Memory Address Test (Basic)	A-14
Extended Memory Address Test	A-14
Memory Power on/off Test	A-14
Extended Memory Control & Time Share Test	A-14
Teletype Control Test	A-14
Option Maintenance & Diagnostic Programs	A-15
KE8 EAE Test Part I	A-15
KE8 EAE Test Part II	A-15
DB8-E Interprocessor Buffer Test	A-15
DR8-EA Digital I/O Diagnostic	A-15
LE8 Line Printer Diagnostic	A-15
PC8-E High Speed Reader/Punch Tests	A-15
CM8-E Optical Mark Card Reader Test	A-15
CR8-E Card Reader Test	A-15
LA30 DECwriter Diagnostic	A-15
TD8-E DECTape Diagnostic	A-16
TM8-E Control Test (transportless)	A-16
TM8-E Control Test (with transport)	A-16
TM8-E Drive Function Timer	A-16

TM8-E 9 Track Data Reliability Test	A-16
TM8-E 7 Track Data Reliability Test	A-16
TM8-E Random Exerciser	A-16
KP8-E Power Fail/Auto Restart Test	A-16
XY8-E Plotter Control and Display Diagnostic	A-16
AD8-EA, AM8-EA A/D Converter & Multiplexer Tests	A-16
VC8-E Point Plot Display Diagnostic	A-17
DK8-E Clocks Diagnostic	A-17
DP8-EA/EB Synchronous Modem Interface Diagnostic	A-17
DP8-EP Redundancy Check Option Diagnostic	A-17
SECTION 2 OPTION PROGRAM PACKAGES	A-17
Basic Software Kit	A-17
Extended Software Kit	A-17
Software for KM8-E Memory Extension	A-18
Time Sharing Software Kit	A-18
PS-8 DECTape System Software	A-19
PS-8 Paper Tape System	A-19
DCO2-F Software	A-20
XY8-E Software	A-20
DIBOL Software	A-20
APPENDIX B TABLE OF INSTRUCTIONS	B-1
APPENDIX C TABLE OF CODES	C-1
APPENDIX D PERFORATED-TAPE LOADER SEQUENCES	D-1
APPENDIX E LINE PRINTER CHARACTER CODES	E-1
APPENDIX F SCALES OF NOTATION	F-1
APPENDIX G POWERS OF TWO	G-1
APPENDIX H OCTAL-TO-DECIMAL CONVERSION	H-1
APPENDIX I HARDWARE TECHNICAL MANUALS	I-1
APPLICATIONS	DEC-1

THE PDP-8/E STORY

The PDP-8/E story is a guided tour, using pictures and descriptions, of Digital Equipment Corporation. We want you to see the skilled people, the manufacturing processes, the scores of test stations, and the wide variety of DEC products—all of which contribute to produce the finest, most cost effective computers and related products on the market.

At our production facilities in Maynard, Westminster, and Westfield, Massachusetts; Carlton Place, Ontario, Canada; San German, Puerto Rico; and Galway Bay, Ireland; computers are used extensively to design, produce and qualify new computers. After each computer has passed all of its qualifying tests and is accepted by DEC's quality control and field service groups, it is shipped with the full assurance and guarantee that the computer will provide the outstanding performance and dependability that our customers expect.

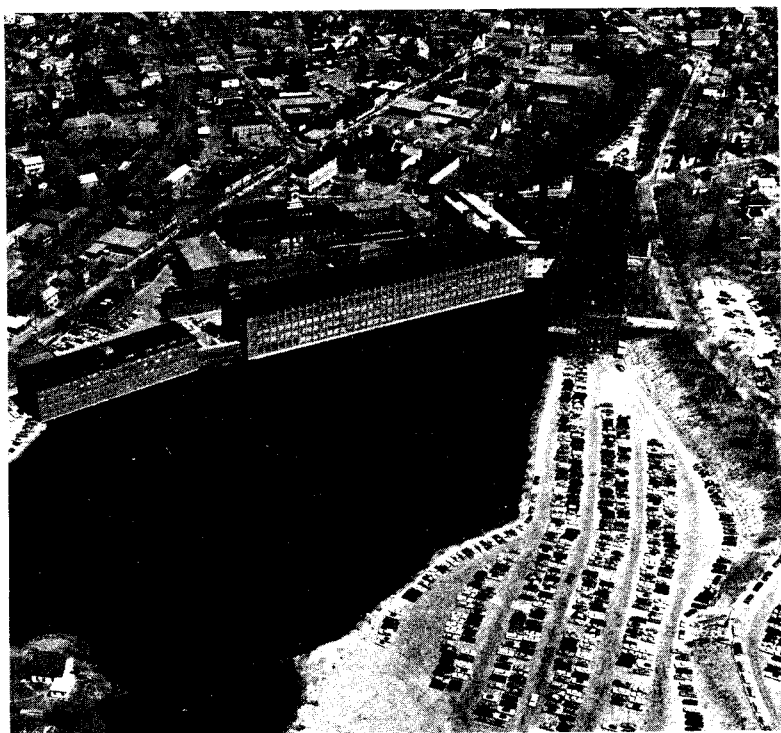

The home office and main manufacturing facilities for DEC, the third largest computer manufacturer in the world, are located in this mill complex in Maynard, Massachusetts. We have 1,000,000 square feet here, about 100 times more than when the company started producing digital modules 14 years ago.

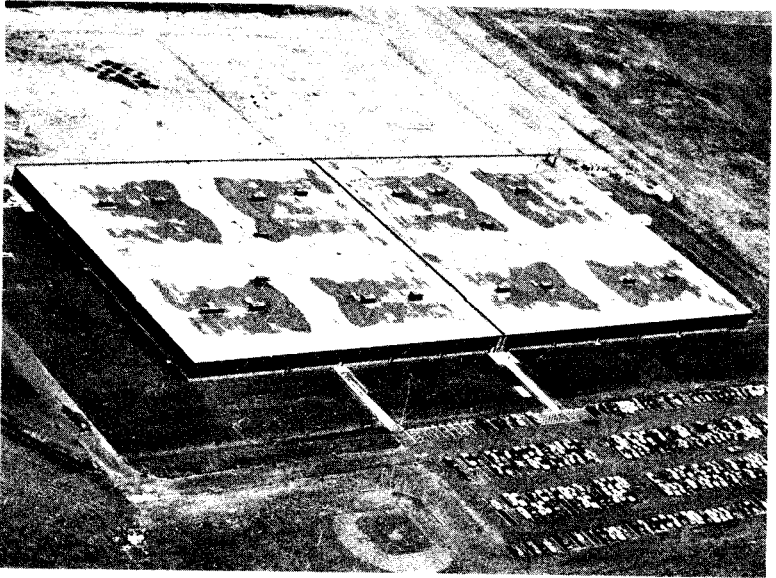

Westfield Plant — Westfield, Massachusetts, U.S.A.

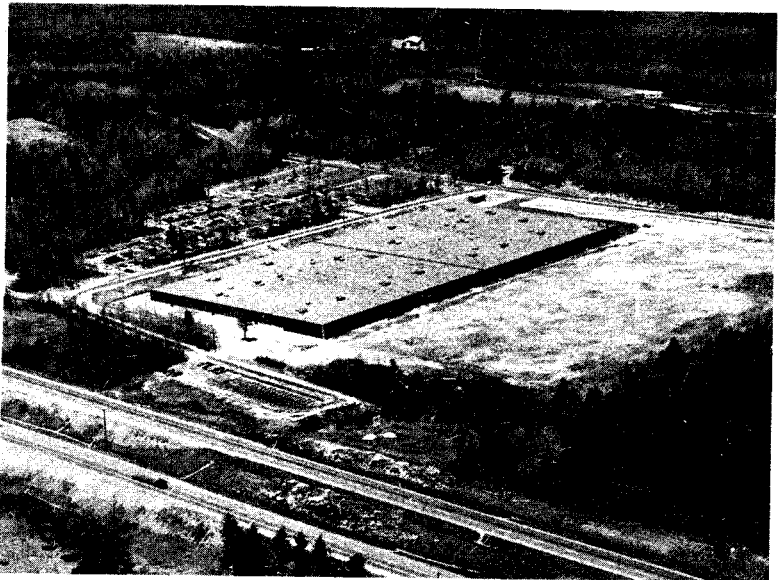

Westminster Plant — Westminster, Massachusetts, U.S.A.



Mountainview, California

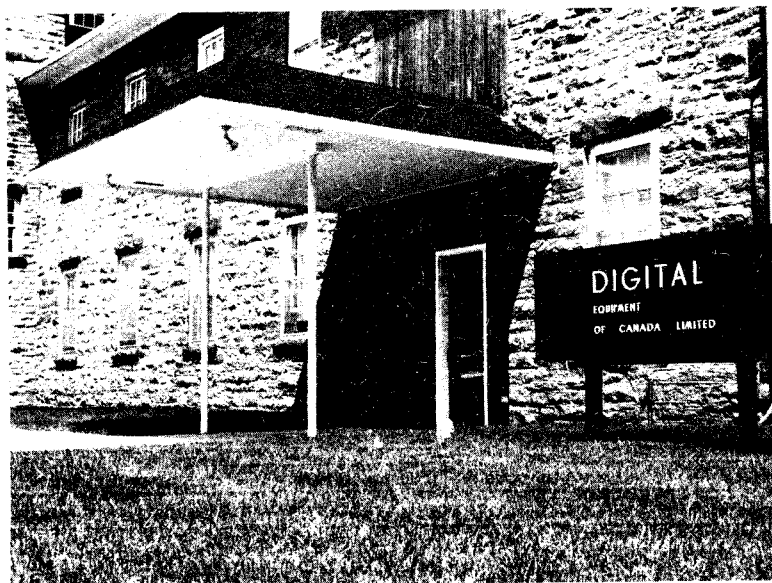

Carlton Place Plant — Carlton Place, Ontario, Canada

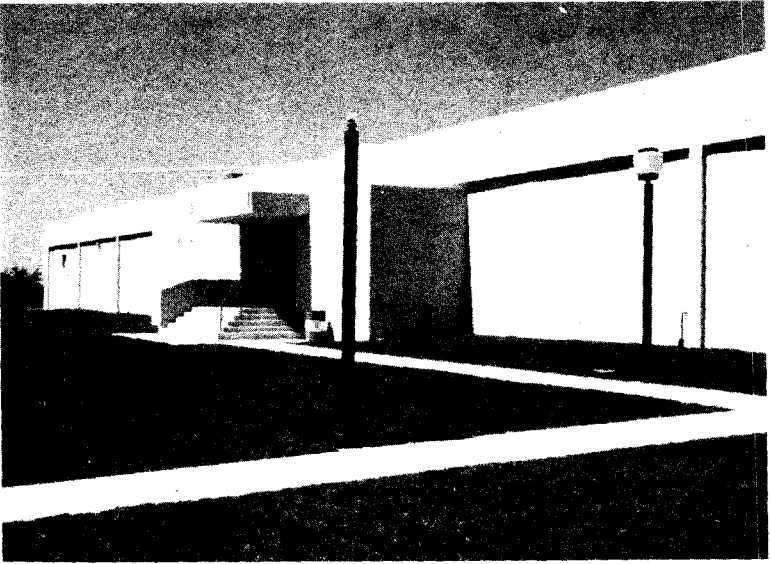

Galway Bay Plant — Galway Bay, Ireland

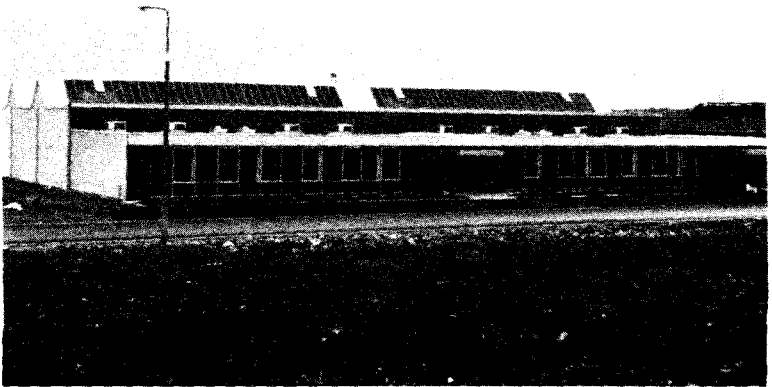

Puerto Rico Plant — San German, Puerto Rico

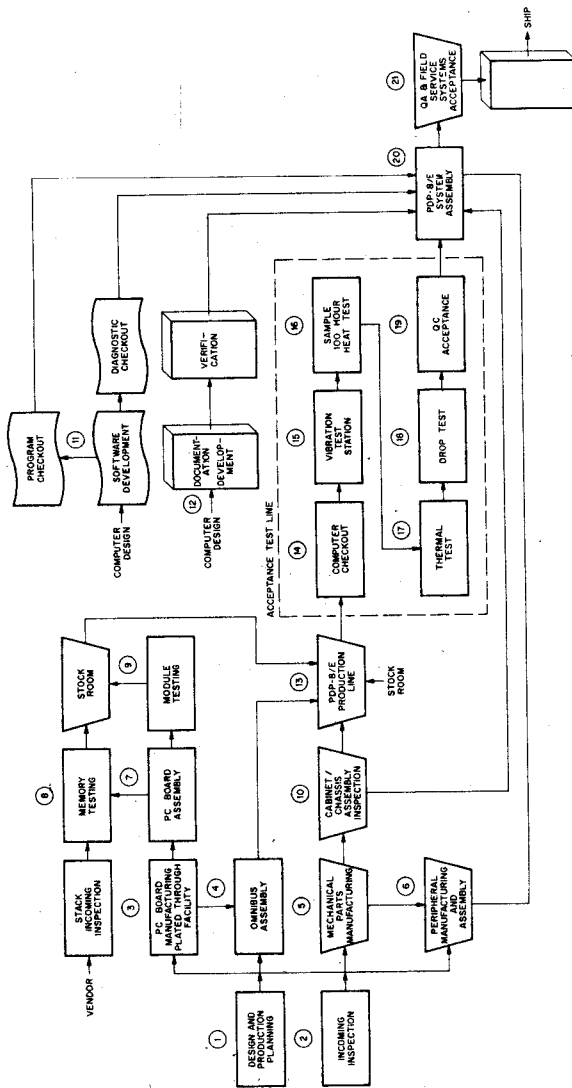

THE STORY

A diagram is provided for you to relate the photo-story to the actual events that occur here every day at DEC. It begins with design, evolves to incoming inspection of components and raw materials, then progresses to a finished computer system ready for shipment to a customer. The numbers in each block refer to the part of the story about that particular process or test.

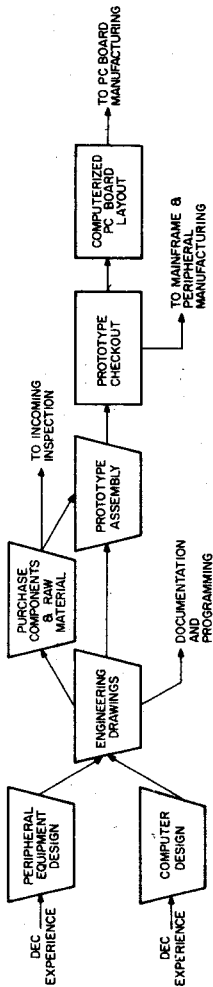

(1) Design and Production Planning

The experience that DEC has acquired from many years of computer and peripheral manufacturing goes into DEC's newest computers and peripherals. No equipment is manufactured until the prototype has undergone full evaluation by engineering, quality assurance, and field service.

After evaluation, production planning begins. New test stations to accommodate high volume testing are designed and produced. DEC's programming department immediately goes to work on new programs for all computerized testing.

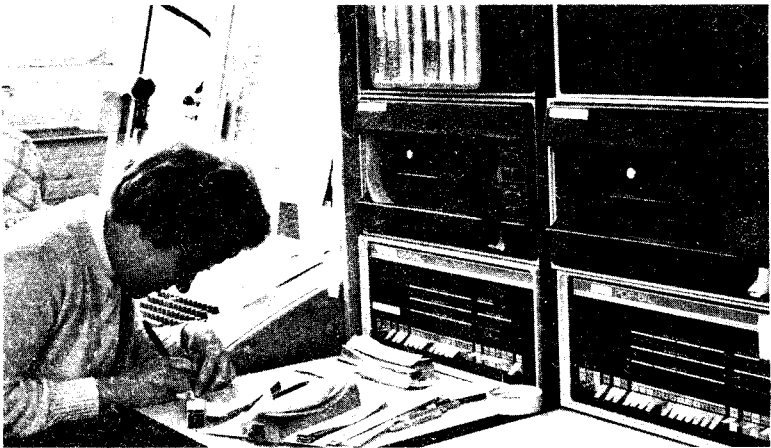

DEC uses a PDP-8 Computer with a Digitizer to prepare for highly accurate automated drilling operations on PDP-8 logic module boards. Drilling coordinates are retrieved from a layout of a module (shown on the drating table). The information is stored in core memory, and the computer generates a paper tape that contains digitized information about the location of the holes to be drilled in the module boards.

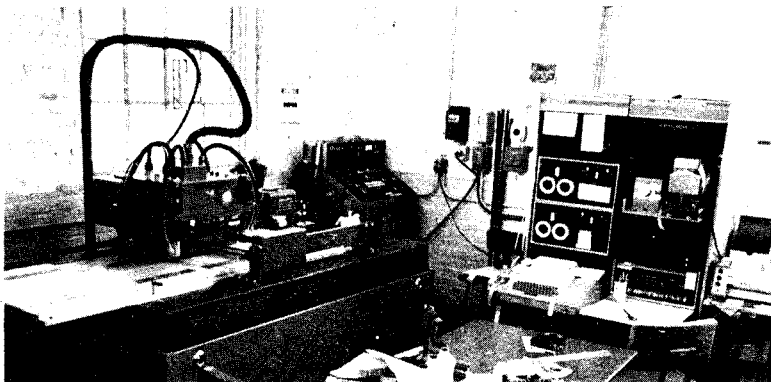

The paper tape containing the digitized information is then taken to another PDP-8 computer for post processing to produce another paper tape with all of the various control signals to run the drilling machine. Thus, a PDP-8 Computer is actively involved in producing new PDP-8 Computers.

The X- and Y-coordinate information is first plotted out on an automatic plotter to check its accuracy and then post processed in the larger PDP-8 Computer. Next comes a test run on the drilling machine to see the results.



DEC uses computers to design more computers.

The PC board layout system (using a PDP-8 Computer, a KV Graphics System, and a Digitizer) is another example of computers being used to design more computers.

The computer is used to design and lay out each circuit board and obtain drilling coordinates.

The system provides the layout of a PC board from hand-drawn sketches by inputting X- and Y-coordinate information into the computer in digitized form. When the operator wants a connector to be placed at a particular location, he locates the digitizer cursor at the starting point and commands the computer via the Teletype®. The appropriate connector appears on the graphics display.

This information, in digitized form, is available to lay out the PC board, drill holes for the various components, operate the computerized component insertion machine, and other specialized functions. With this system, DEC is able to computerize a large part of the process of laying out and producing printed circuit boards.

® Teletype is a registered trademark of Teletype Corporation.

QUALITY

We have built more than 12,000 computers. Naturally, at DEC computerized testing techniques play a major role. Dynamic testing controlled by computers begins as each component is received at the plant and continues through most all production phases. As the major components of the computer progress through the assembly lines, the testing becomes more and more complex, and culminates with the final acceptance test of the finished system. Before a unit progresses to the next assembly or test station, it must meet the rigid standards imposed by DEC.

Computerized testing is ideal for quality control. Many similar tests are continually being run. By automating the tests, all results are calculated the same way and printed out in a standard format, thereby increasing test reliability and accuracy. The cost of quality control tests is drastically reduced by cutting manhours required for other test methods. The computer can control the tests, as well as acquire data and calculate results, and the system is flexible enough to make real-time "decisions" as the test progresses.

The advantages of using small computers during design, production, and testing are mainly economical. Small computers are inexpensive and can be located in the shop, right where the action is.

In manufacturing, computers provide on-the-spot testing. When repeatability of testing is important, computers make certain that all components meet the required standards. A computer can do the same task identically again and again; human variation in performing tests is virtually eliminated. The result is a test that is identical for each component being tested.

A written record of test results is often necessary. In computerized testing, the record is available the instant the test results are available. This is particularly important, especially on an assembly line where the unit must be qualified at one station before moving on to the next station. The test operator can press a button and instantly receive a printout of test results.

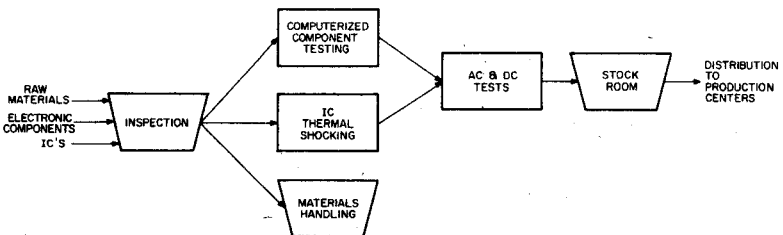

(2) Incoming Inspection

Inspection, testing and more testing, right from the beginning, is a major factor in the PDP-8 family success story. All material, components, and integrated circuits (ICs) must pass rigorous inspections before being placed in DEC's stock room.

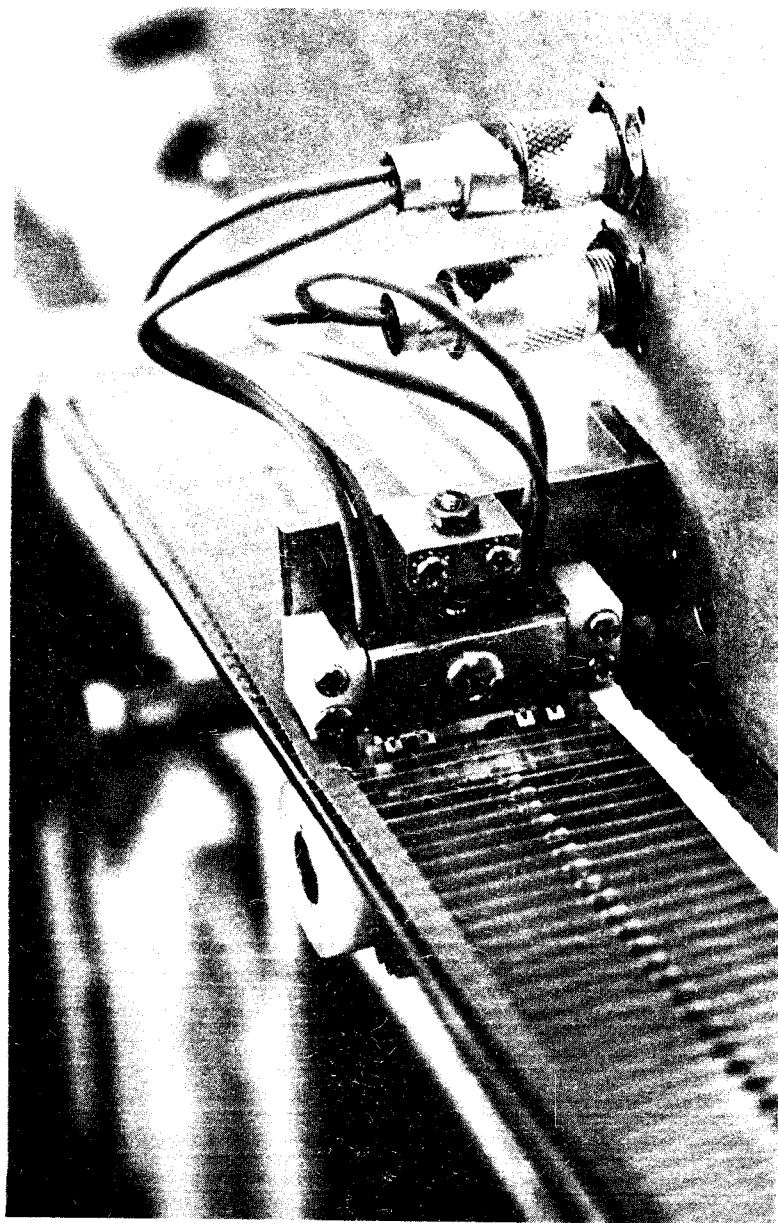

All incoming components are 100% tested. Here, diodes are being tested automatically.

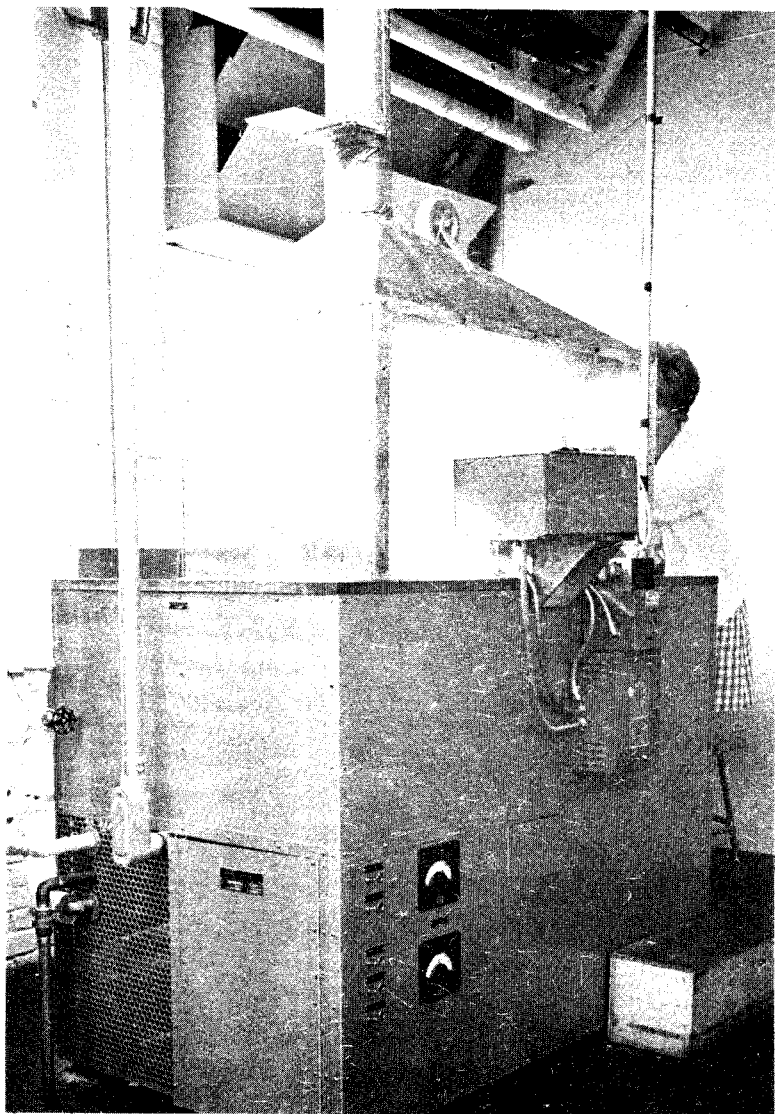

All incoming IC's are tested—The IC Thermal Shocking Process

IC's are first given a cold test by placing the IC's into a bath at 32°F for 2 minutes. The IC's are then cycled into another chamber at a temperature of 212° F to force any possible fault to appear. Then testing for faults begins.

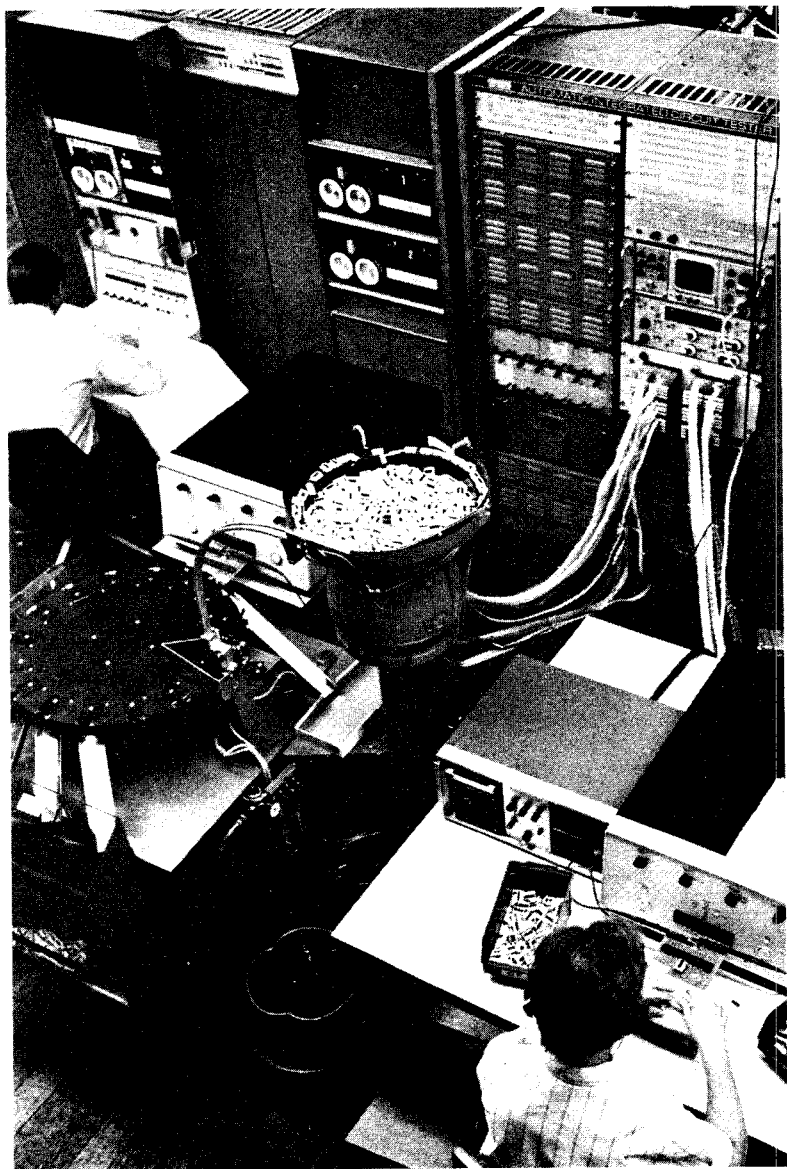

All incoming integrated circuits under computer controlled testing, with 40 dc and 16 ac tests performed in 1.1 seconds. This 100% inspection speeds production by minimizing the diagnosis of component failures in module test.

(3) PC Board Manufacturing Plated Through Facility

The manufacturing of printed circuit (PC) boards requires a facility that provides a controlled process and rigorous quality control. DEC is a world leader in the manufacturing of logic modules. We produce more than 3,000,000 modules per year and have been producing logic modules since 1957.

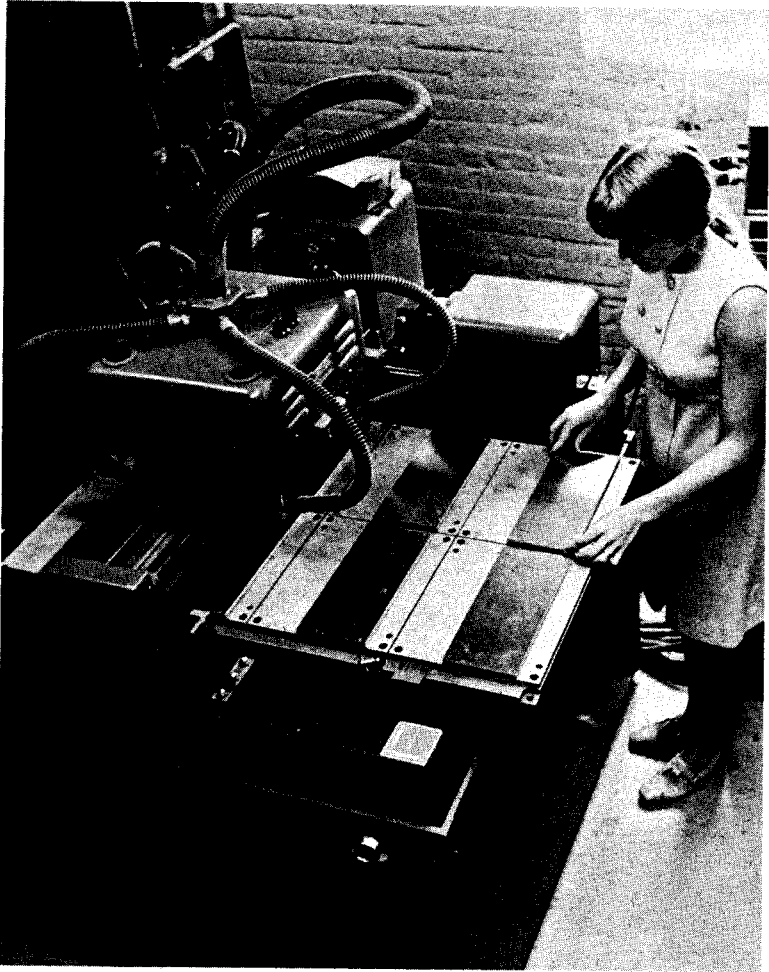

Twenty module boards are drilled simultaneously from a PDP-8 computer-generated coordinate tape. Other pantograph-controlled machines drill up to 200 boards simultaneously from a PDP-8 computer-generated template.



Quality of plated-thru holes is checked in our new electrochemical facility before boards go to the module assembly area.

(4) OMNIBUS Assembly

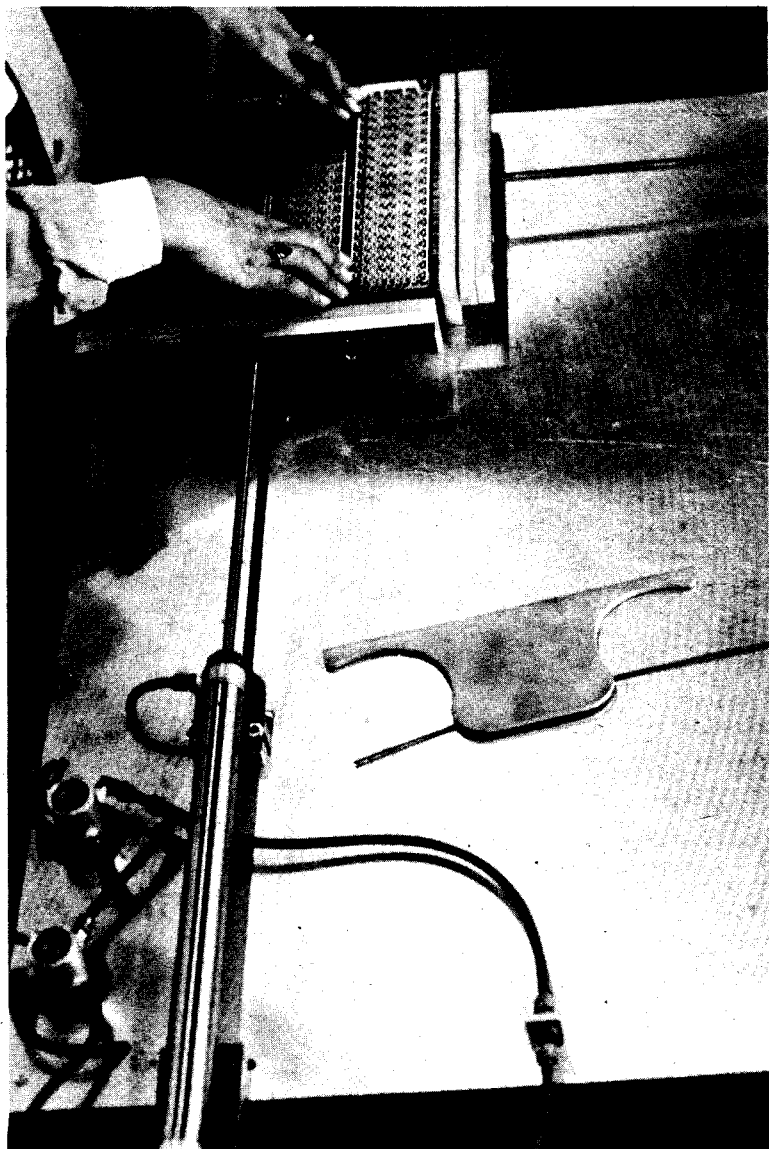

OMNIBUS Assembly—A PC Board and Connector Block are assembled here.

(5) Cabinet Assembly

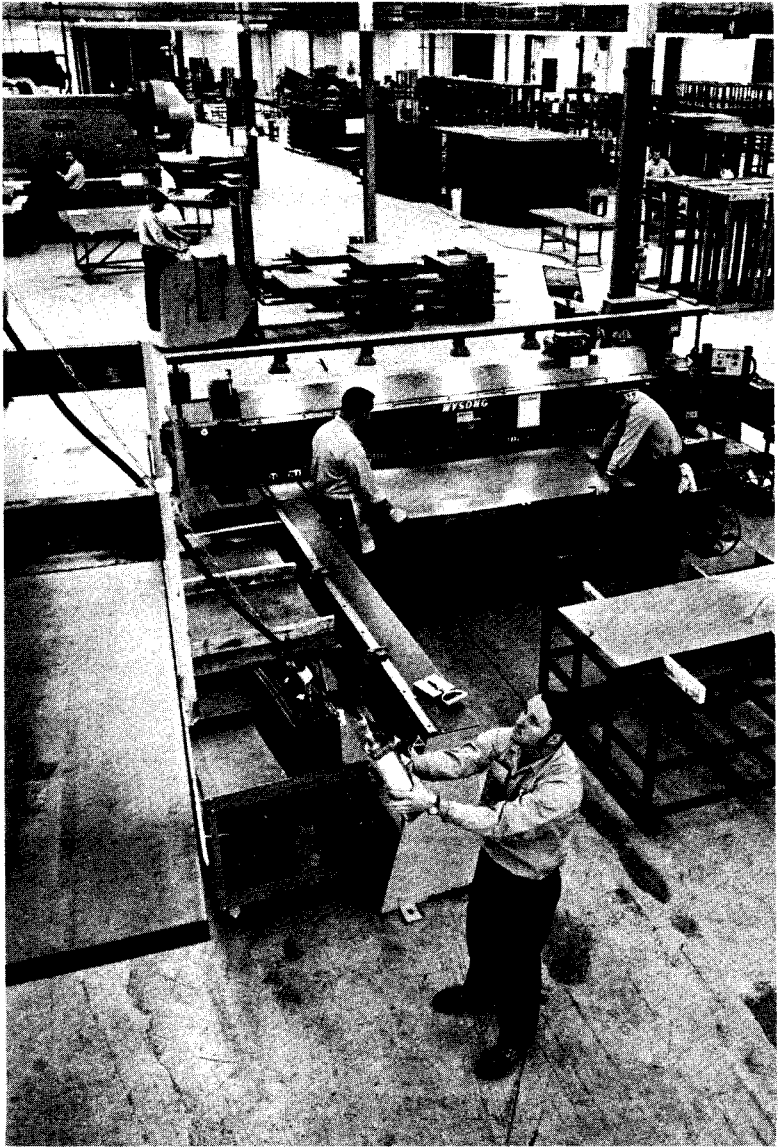

Cabinets for DEC systems are manufactured in this portion of DEC's Westfield, Massachusetts production facility.

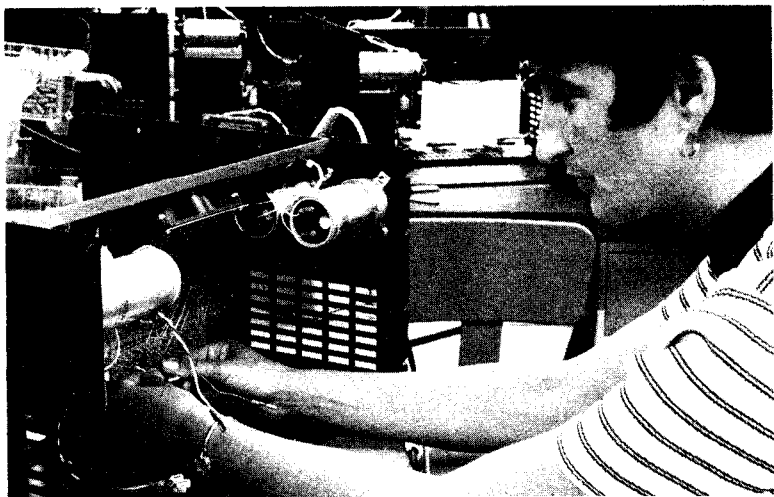

(6) Peripheral Manufacturing

The blossoming of more peripheral assembly lines is a very real indication of DEC's continual expansion of products. At the DEC manufacturing plants shown above, just such an assembly line is producing the famous DECTape. Each component is given the usual controlled inspection procedure. Modules, which are used to control the operation of each DECTape, are produced in DEC's automated module assembly area. Quality control is the highest priority item. A series of severe tests and checks are run on all products.

(7) PC Board Assembly

The PC Board Assembly includes inserting components, soldering component leads and gold plating all printed circuit connectors.



Component Insertion Machine

DEC designed and built a multistation component-insertion system to insert diodes, resistors, and capacitors into PC boards. Eight stations are controlled by one PDP-8 Computer. Each station contains a component-insertion machine with table driven stepping motors directly coupled to a rotary incremental-optical encoder.

An X-Y table holding a batch of printed circuit boards is stepped back and forth under a stapling mechanism that inserts electronic components into predrilled holes on the boards at high rates.

The PDP-8 System uses a magnetic tape deck containing a library for PC-board parts lists. Each station has a custom-built control panel that permits the operator to start, stop, back up, go forward, jog-in offsets, and select parts from lists. The electronic parts are loaded into the insertion machines in paper-taped belts on large reels.

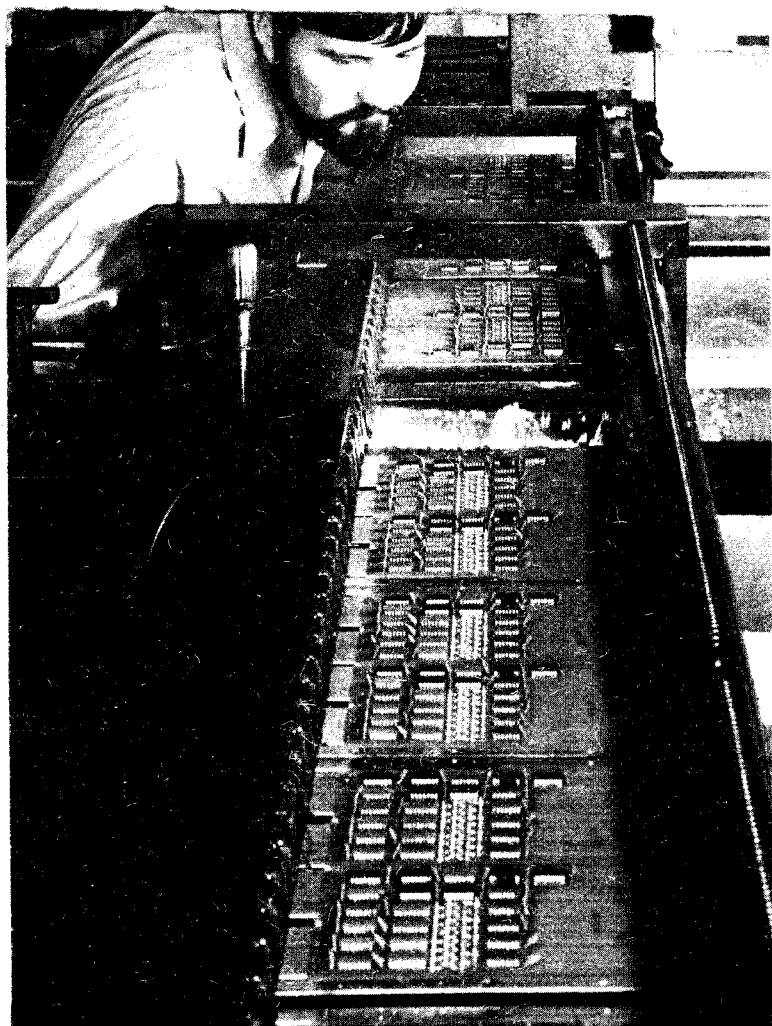

This flow-soldering machine solders all component leads to the board and makes all solder runs in one fast, exceedingly reliable, operation. More than 1000 modules are soldered on this assembly line each day.



DEC has more than 2 million square feet of manufacturing space. This view shows a portion of a module assembly area.

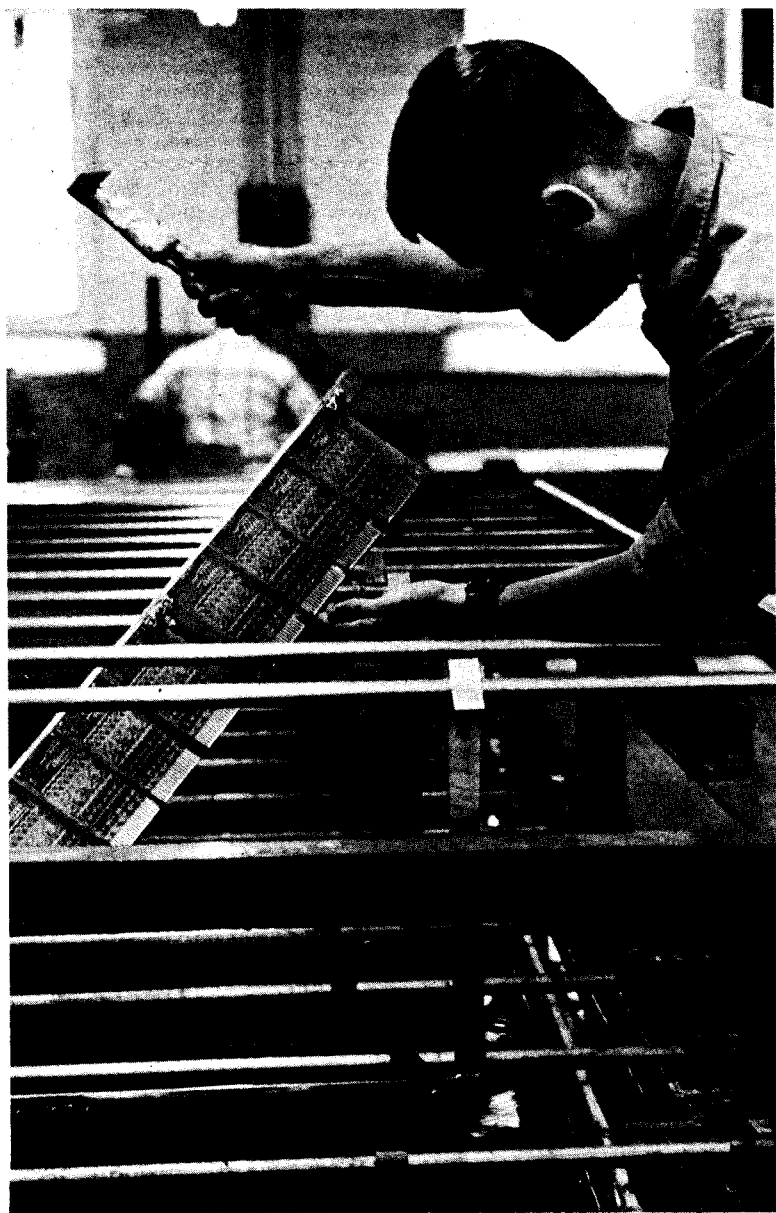

Checking the appearance of board contacts being gold-plated. Our 100 micro-inch plating is verified by periodic checking on a radiation gauge.

(8) Computers Test Memory Systems

Computers perform three complex testing operations on each memory system before it is approved by quality control. Each module is visually inspected and taken to a manual memory exerciser, qualified, and placed with other modules where a memory system kit is assembled. A complete memory system test is performed, and the assembled memory system is qualified. A final test is performed with diagnostic programs, exercising the memory system at its highest specified temperature limits in a heat chamber. Refer to MM8-E flow of inspection and testing.

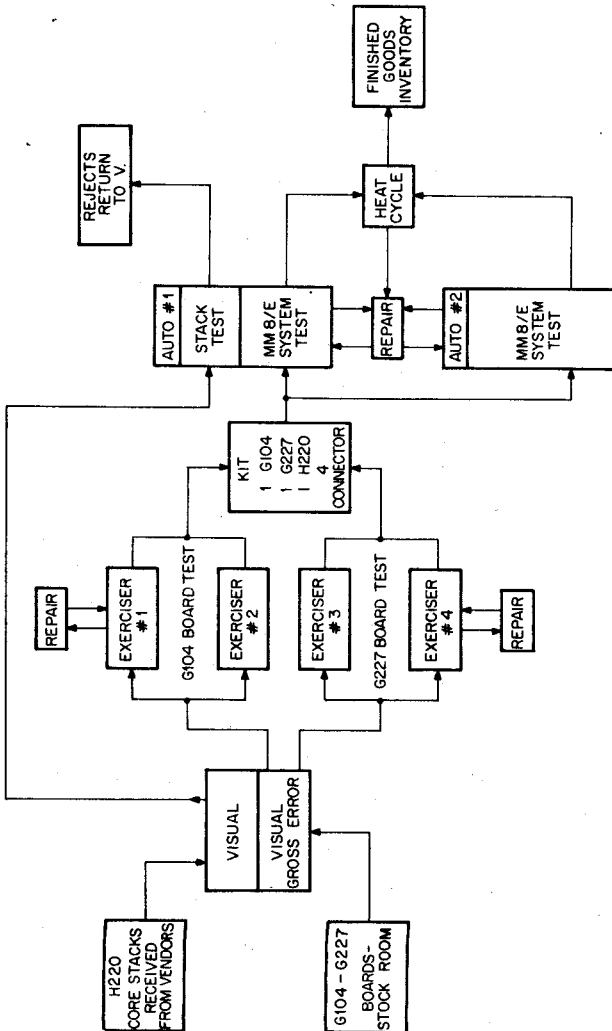



Memory Test Line

Qualifying PDP-8/E memory modules is accomplished by this test line. Every component in the memory modules are subject to thorough testing under a variety of conditions.

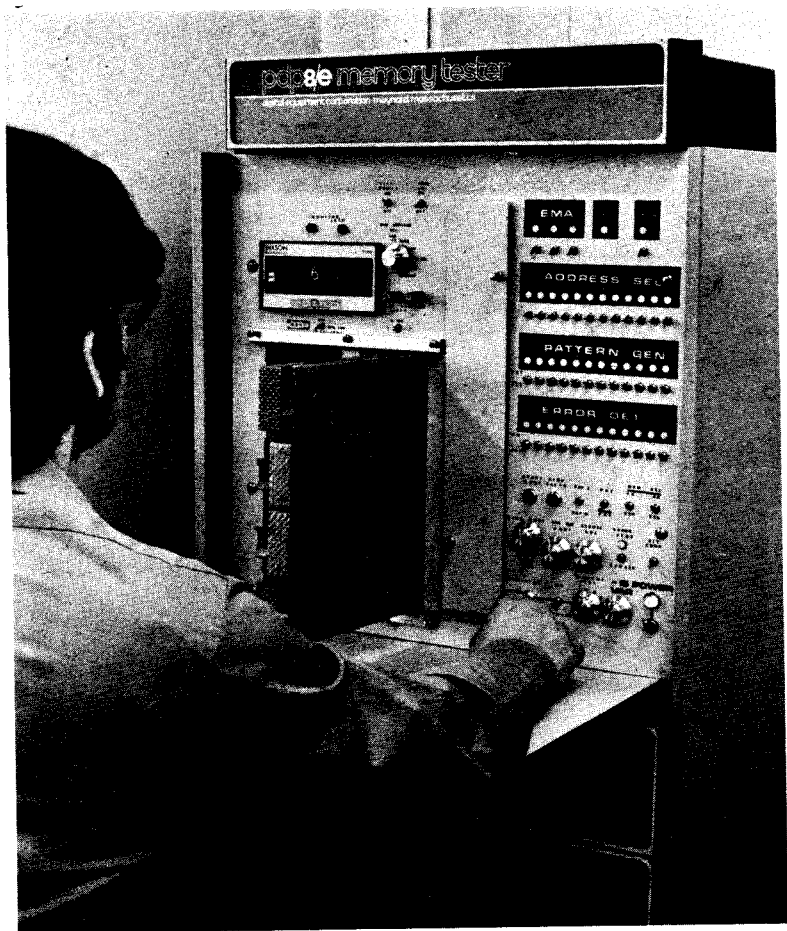

The PDP-8 Computer performs the dynamic testing of the memory units (MM8-E's—3-card ensemble). After each memory system kit has been assembled, the kit is tested at DEC's fully automatic station (AUTO #1 or AUTO #2) where typical operations of system characteristics are run to reflect normal operating frequency used by the computer. The tester varies the voltages and currents within the memory system upper and lower limits to ensure that the memory system meets the requirements of the specification. For each parameter tested, corresponding Schmoop-type curves are obtained. The total test time requires only 5 minutes for each memory system tested.

Again, a PDP-8 Computer is working to qualify new PDP-8 Computers. This automated testing technique allows no variation in quality; no marginal units survive these tests.

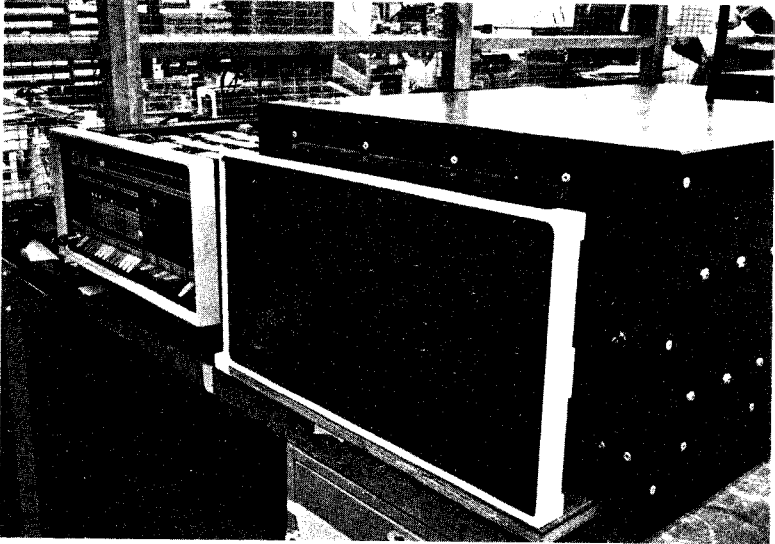

Memory System Heat Test

A final system test is performed by running memory diagnostic programs while the system is operating under maximum allowable temperature. The memory modules are installed in a heating chamber and connected to a PDP-8 Computer. If a fault occurs, a teleprinter connected to the computer prints out the type of fault; if the memory system performs flawlessly, the teleprinter prints a verification.

(9) Computers Test Logic Modules

A series of computerized tests are performed on all logic modules to maintain DEC's highest standards and ensure long life. Computers using diagnostic programs exercise and test every component on every module before a module is qualified for customer use. Hundreds of repetitive tests are performed in seconds as the computer evaluates every parameter, including maximum and minimum allowable current, frequency, and other important values. If a fault occurs, a teleprinter signals the operator; otherwise, the teleprinter verifies that the unit "passed the tests."

A detailed diagram of module testing is provided below, from the least complicated test to the most complicated test. Computerized testing begins with the edge check, which qualifies all of the circuit paths. If the module is simple, it is routed to the universal tester; otherwise, the module is qualified by the complex module tester. Any time a component failure is detected, a "chip" test is run to locate and replace the failed component. Each accepted module is then tested in a PDP-8/E System and qualified by a series of diagnostic programs that thoroughly exercise every component on the module.

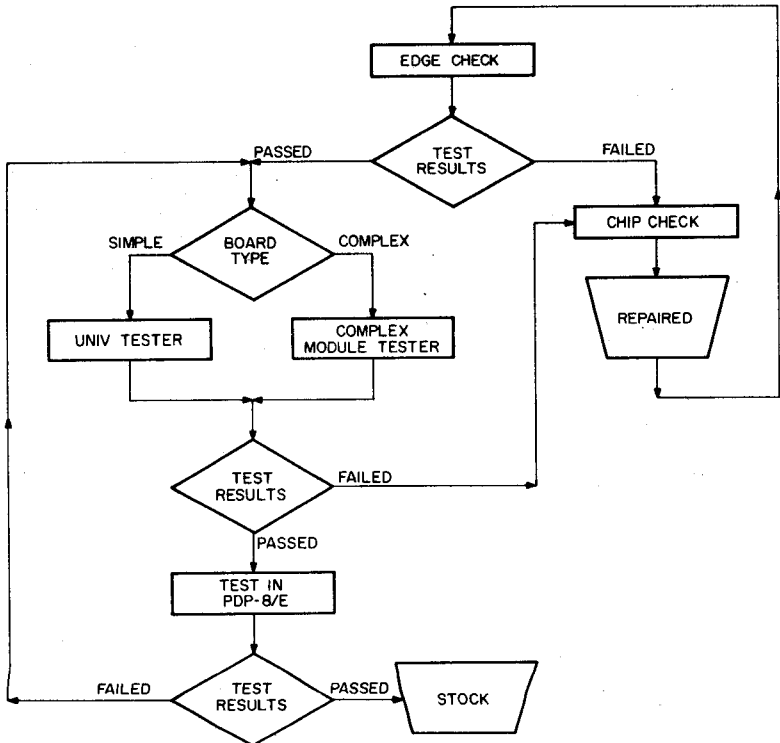

Module Computerized Tests Flow Diagram

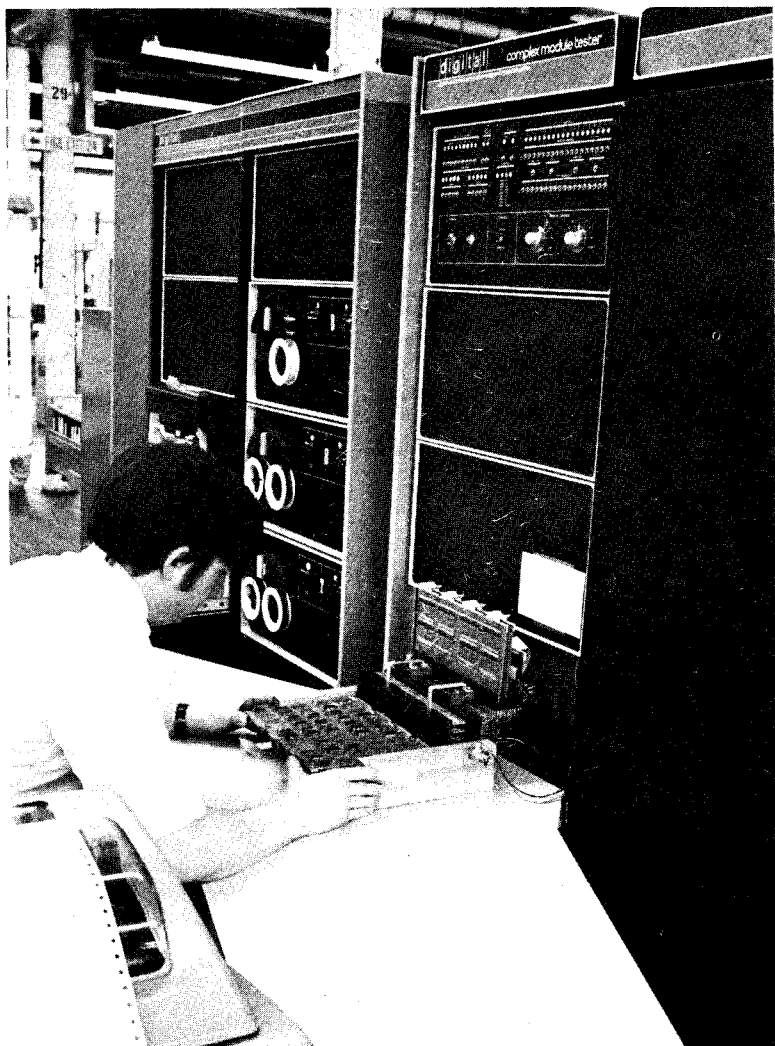

Module Computerized Tests

Complex Module Tester—The Complex Module Tester uses a Computer. The operator inserts the circuit board into a connector block and the computer applies the correct inputs and checks the correct outputs from that circuit board to verify its operation. If the circuit board is rejected here, it is passed to another test center where a technician uses the Universal Tester to further diagnose the fault.

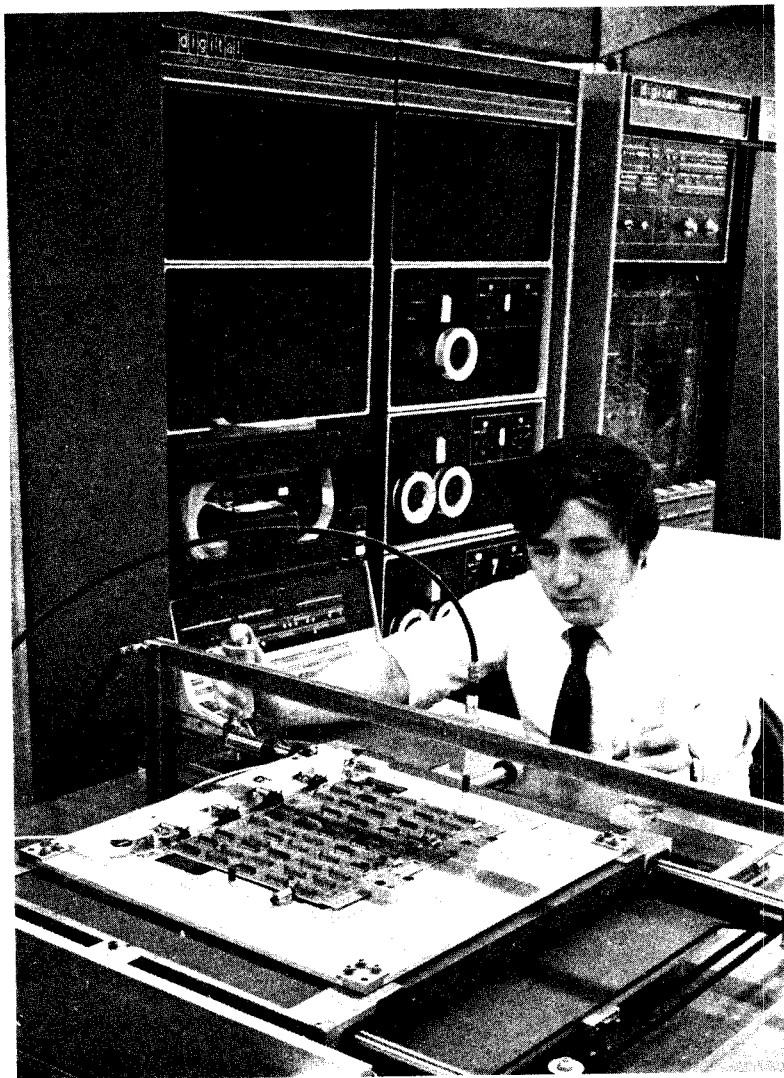

Chip-Checker—The chip-checker tests individual IC's while mounted on a module board. This unit indexes in X and Y around a circuit board with a special probe that connects to and checks out each integrated circuit on the circuit board. The computer in the background stores the programs for both testing and indexing the tester. DEC tests the integrated circuits (IC's) before being assembled on a circuit board by the incoming inspection method and tests once again after the IC's are assembled on a board.

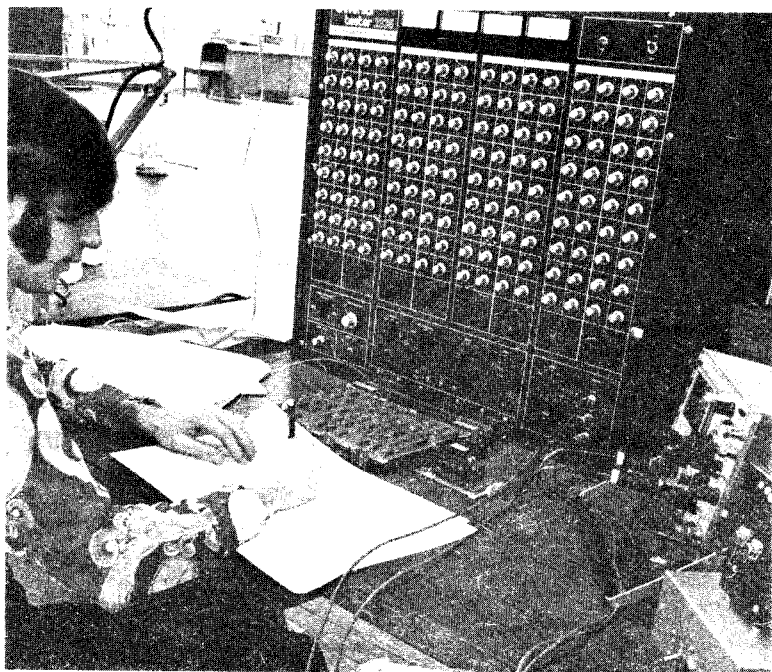

Universal Tester or Logic Analyzer—This unit is the tester especially developed for PDP-8/E modules. Using this sensitive tester, a technician can isolate faults on any circuit card used in the PDP-8/E Computer. Through the various controls on the tester, the technician sets up all the various inputs that a circuit board uses. Then, with an oscilloscope he can monitor the output at various pins to verify the operation of circuit paths.

(11) Software Development



We develop new PDP-8/E software every day. Each new program is exhaustively tested on a PDP-8/E Computer before it is released for customer use. In addition to programs developed for customer use, DEC has developed a special series of diagnostic tests that are used by the various test stations.

(13) The PDP-8/E Production Line

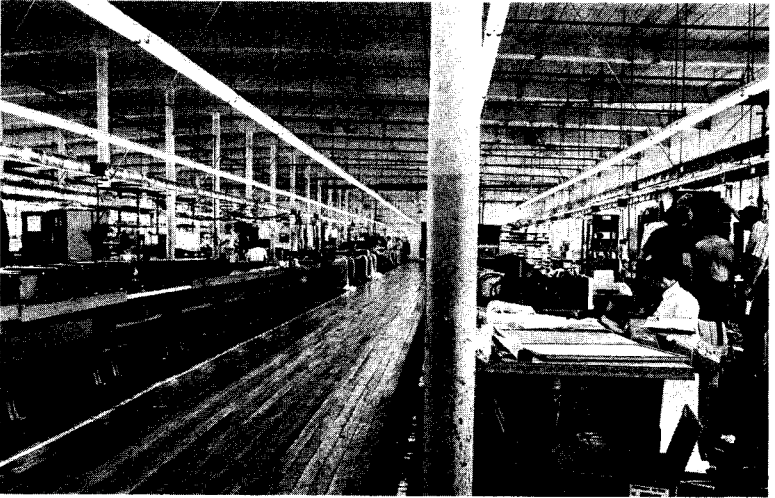

The PDP-8/E production line has the capability of manufacturing 1,000 PDP-8/E Computers per month.

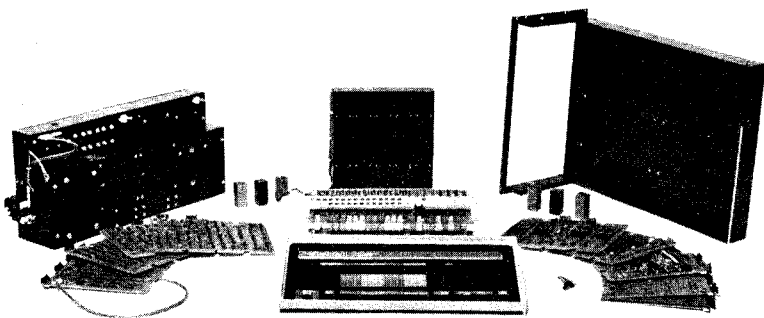

PDP-8/E System Assembly—After testing all the various components of a PDP-8/E Computer, the components are carefully assembled. This photo shows all of the components for a basic 4K Computer arranged to illustrate how modular the 8/E is and how spare parts can easily be the key to zero downtime.

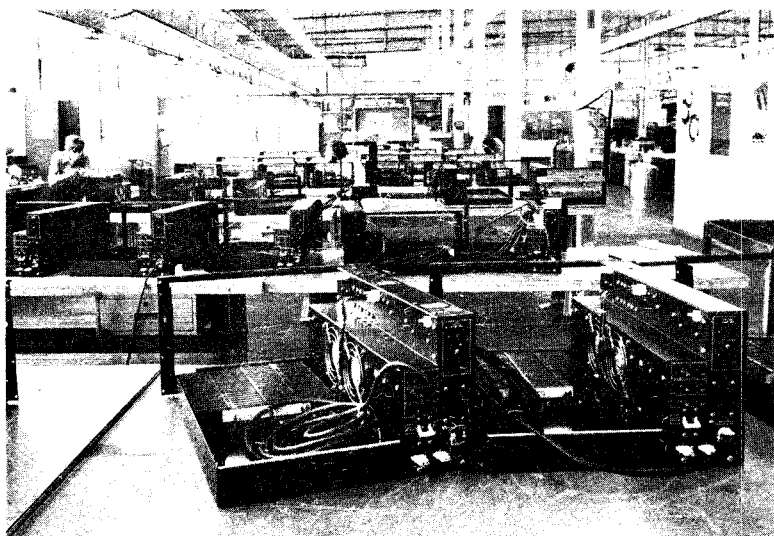
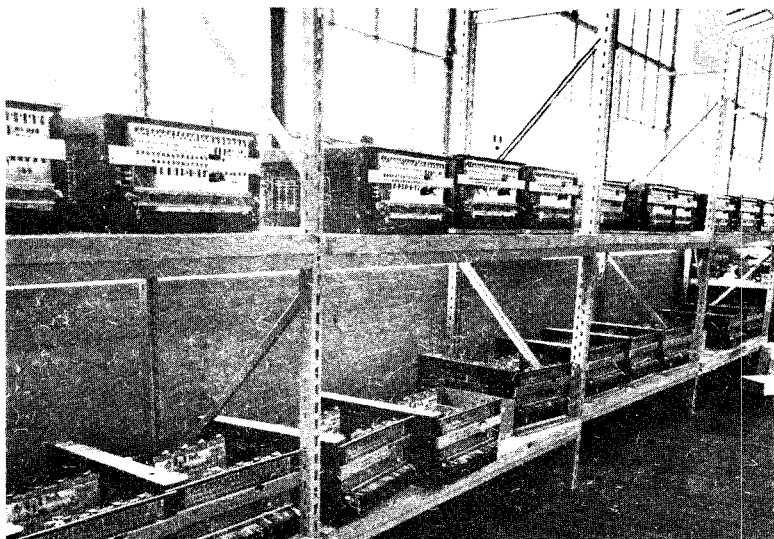

Final Assembly Area

Here, 40 PDP-8/E Computers are shown in various stages of assembly. After assembly is complete, each unit is moved to another area where power is applied and the assembled unit is tested.

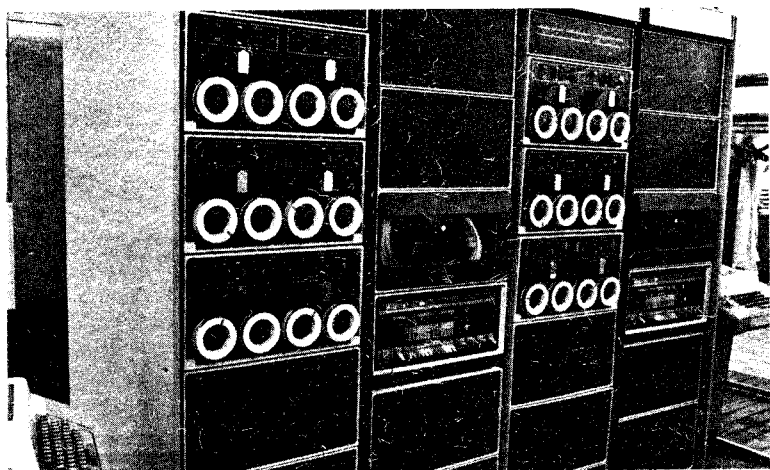
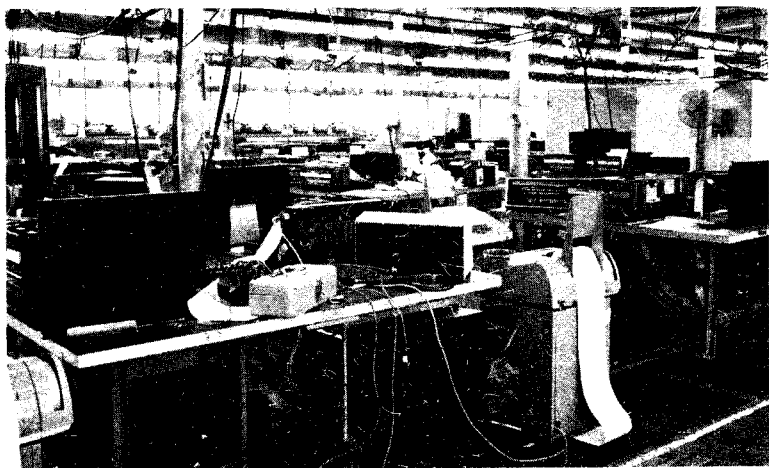

Acceptance Test Line

Assembled computer testing is done in DEC's acceptance test line. Up to 64 test stations can be controlled by one of two PDP-8/E Computer Systems; there are 6 DECTapes on each system, containing an assortment of test programs and exercises for each test station. Thus, 64 computers can be tested simultaneously by a master controller. The PDP-8/E master controller loads diagnostic programs directly into memory of the new PDP-8/E computers under test, thereby checking out the new computers thoroughly and efficiently. The DECTapes contain all of the programs required to check out the various PDP-8/E's, as well as the operating programs to control the entire test line.

(14) Computer Checkout

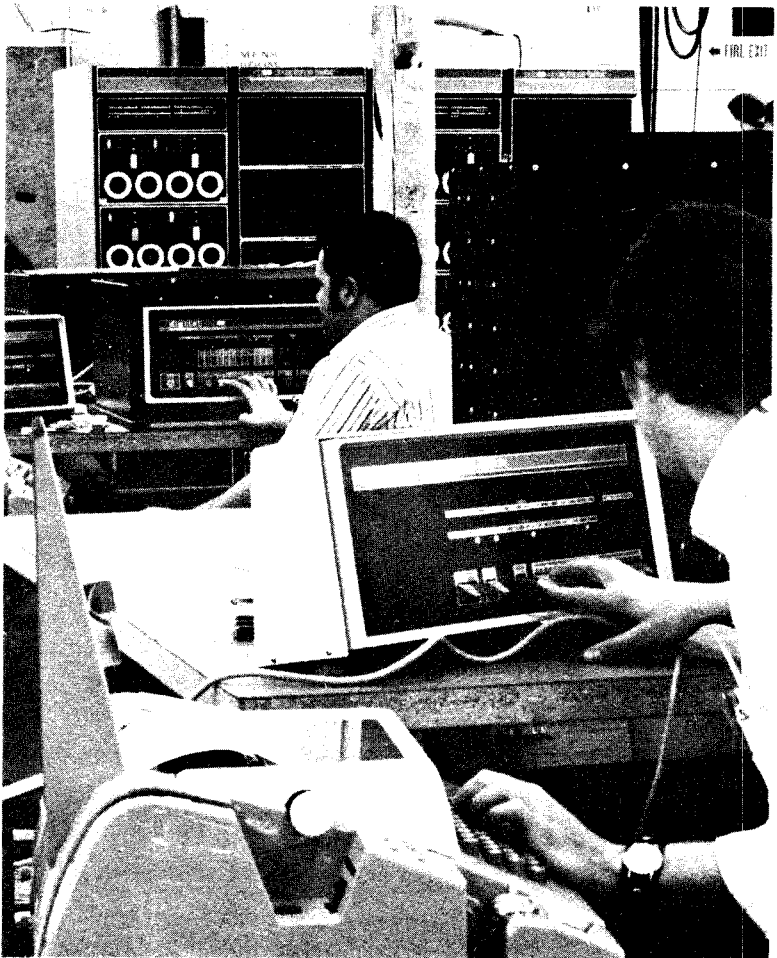

All assembled computers are tested at the 8/E Acceptance Test Station. By coding of the switches on the front of the computer, a technician can request certain diagnostic programs to be loaded into the PDP-8/E. Another switch enables Auto or Manual operation. The technician can either manually go through each test program while he is watching the results or place the switch in the Automatic Mode allowing the PDP-8/E Computer to continually cycle the various test programs through the unit without an operator. On the far left of the test panel is a switch labeled HEAT BOX. This switch activates the heater elements of another unit (not shown) and gives the computer a final heat test at this station.

(15) Vibration Test Station

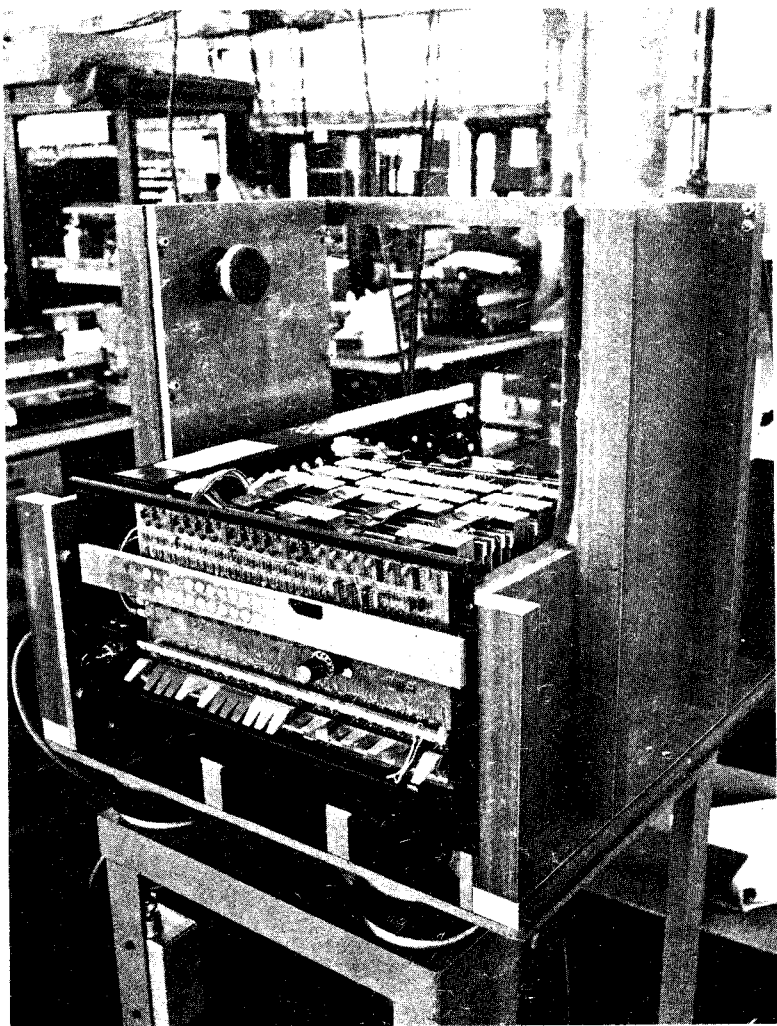

In this production phase of the computer testing, the 8/E is placed on a vibration table and vibrated for several minutes at 70 cycles per second. This test checks for any loose components, cold solder joints, and other malfunctions that can appear under severe vibration conditions. Following this test, the computer is rechecked with the various diagnostic programs. While the unit is undergoing the vibration tests, the memory checkerboard diagnostic is run.

(16) Sample 100-Hour Heat Tests

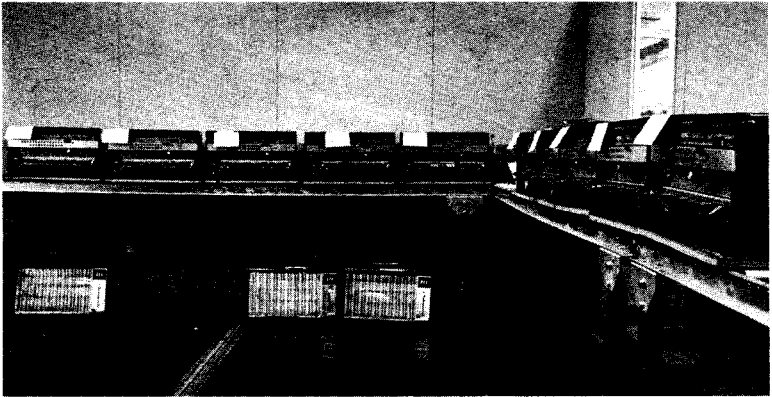

DEC takes a random sample of working PDP-8/Es and runs them for a period of 100 hours at 131° F. This workout allows us to check for "early failing components or sub-assemblies." The information gained helps us to improve the long-term reliability of all the units. In another test, all 8/Es are placed into a cold chamber at 32° F or 0° C. This forces a computer through another thermal shocking process with a very rapid change in its temperature. Following this cycle, the machine is returned to the heat room at 131 degrees F. This two-stage cycle not only verifies operation at the specified limits, but also subjects the machine to much more stress than the environmental change in the field.

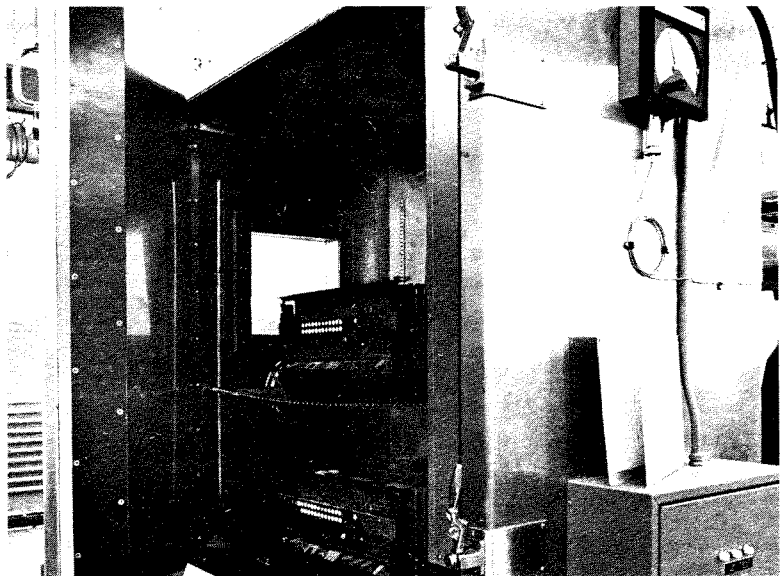

Cold Chamber

(17) Thermal Shocking

As a part of the testing and acceptance process, we place each computer in a cold chamber and a memory checkerboard program is run. The chamber temperature is reduced to the minimum specified temperature of the computer; then, the computer is placed in a heat chamber to operate at 131° F. The acceptance test station detects any faults while exercising the computer under test.

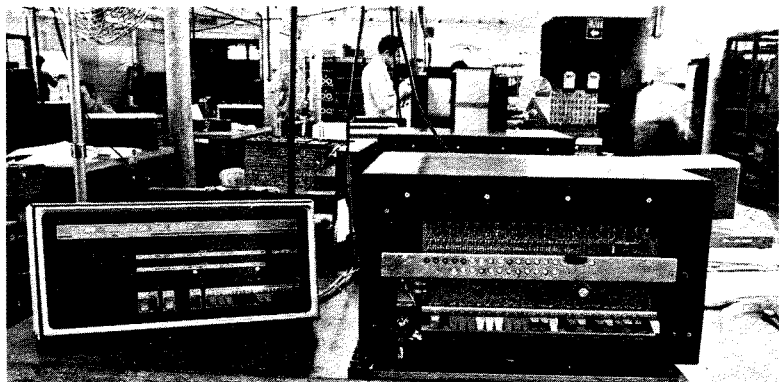

Heat Chamber

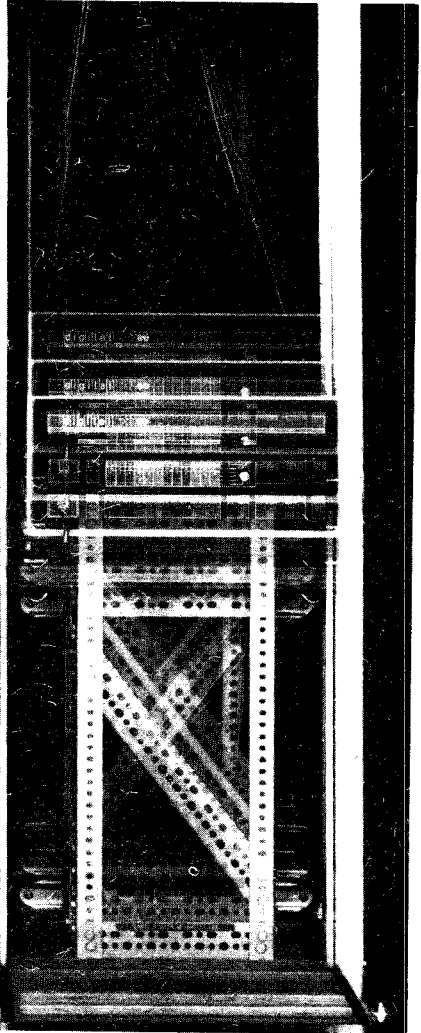

(18) The Drop Test

Some of the most frequent problems in initial installation of a computer are caused by the vibration and rough handling during shipment. To combat these problems, DEC has devised a test that is even rougher than your local transportation company. The 8/E is raised approximately 3 feet above the lower platform and then dropped hard. The test is calculated to place the various components in the 8/E under a 20G force. A second test is performed with the 8/E in a vertical position (panel up) with a 16G impact force.



(19) Quality Assurance and Field Service Acceptance

At the end of the acceptance test line, the Quality Assurance and Field Service Acceptance groups (independent of the production test groups) run their own tests to verify the quality and performance of the units being shipped.

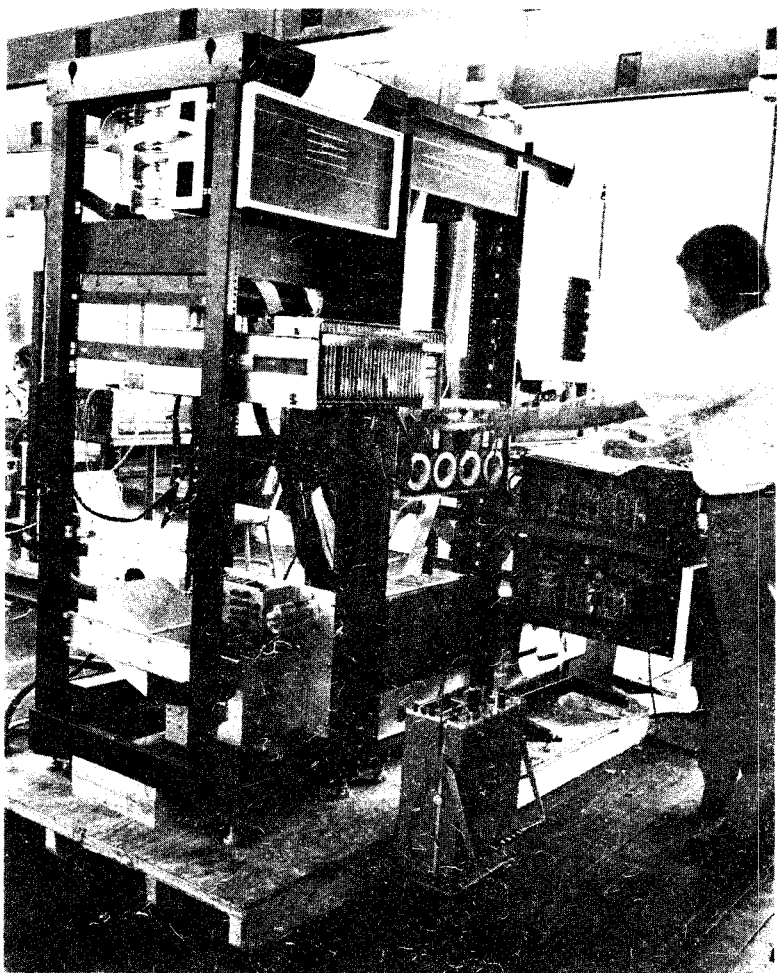

(20) PDP-8/E System Assembly and Test

After checkout of the basic computer and its internal options, the unit is moved to the system assembly area where it is installed in a cabinet containing peripheral equipment to form larger systems. In the system assembly and test area, all customer-ordered options are assembled and tested to make absolutely certain that the system is operating according to equipment and program specifications. This continuing testing process assures DEC's customers, all over the world, that each system delivered will go right to work for them and provide many years of reliable service thereafter.

CUSTOMER SERVICE

With the PDP-8/E computer fully checked out and shipped to a user facility, the scene shifts from the factory to the customer. Each PDP-8/E computer or system is installed by DEC's Field Service engineers. Each installation includes system performance checkout using a series of diagnostic programs and other programs to establish successful operation. Each system (depending upon the purchase agreement) is fully backed by a warranty which assures the customer of complete DEC support at no cost for a period of 90 days.

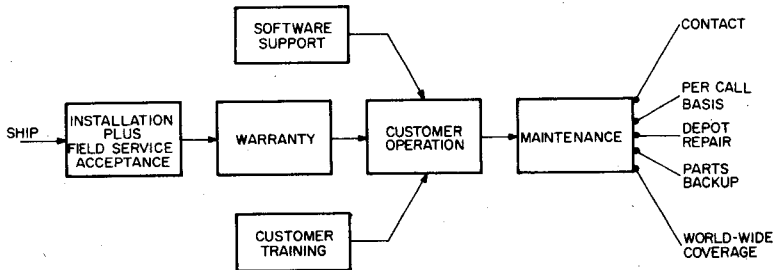

Customer Service

To further support the customer, DEC provides a software support service that assures a complete trouble-free operating software package.

For OEM* customers, DEC provides special documentation support on equipment produced by the OEM. DEC will provide a complete system package containing both theory of operation and maintenance.

How to use the PDP-8/E system and how to maintain it is another customer need that DEC satisfies by offering classroom and laboratory instruction designed to familiarize each customer with his system. Courses include programming, hardware familiarization and system familiarization that provides instruction on how to program a system, how to operate a system, how to maintain a system, and detailed knowledge of the system so that a customer may design and build interfaces to the system.

Each customer has the choice of maintaining his own system or employing DEC Field Service to support his system. His option does not stop there; he may elect to purchase a service contract or simply call his local DEC field service to obtain support on a per call basis. DEC support does not terminate; it continues throughout the life of the computer. The second PDP-1 computer system produced by DEC in 1959 has been supported by DEC Field Service for more than 12 years. This service will continue indefinitely.

* OEM — Original Equipment Manufacturer

CUSTOMER TRAINING PROGRAMS

Digital Equipment Corporation offers an extensive training program to every organization that purchases or presently owns a DEC computer. Our training objective is to familiarize the user with the hardware and software associated with his computer system, and with this in mind, we provide eleven courses for the PDP-8 Family Computers.

Software:
(Programming) Five courses ranging from a fundamental Introductory Programming Course to a sophisticated monitor system course. Designed to enable the user to: utilize the standard system software, write his own system programs, incorporate DEC programs as part of his system programs.

Hardware:
(Maintenance)
(Engineering) Six courses ranging from hardware familiarization to system maintenance. Designed to enable the user to: isolate and evaluate problems if they occur, design interfaces for his system.

Digital offers training facilities in many countries in the world. We presently have training facilities in Maynard, Massachusetts; Palo Alto; California; Australia; England; France; Germany; and Scandinavia. Our training staff consists of full time professional instructors who continually re-evaluate our courses to ensure the content is current and that it meets the needs of our students. Special Arrangements can be made to conduct courses on-site.

The next few pages illustrate our training environment—from the formal classroom aspect to the lab sessions where the student reinforces his classroom learning with actual programming and debugging time on a computer system.

After completing their training, our students leave with a "can do" outlook. Come and find out for yourself.

For further information about our training program and the scheduling of our courses, check the appropriate block on the information request card in the back of the book.

Each Digital customer is provided the opportunity to familiarize himself with all aspects of our computers and peripheral equipment. Professional class rooms employing the latest techniques are used to train customers to maintain and program the PDP-8/E and peripheral equipment. Well equipped laboratories with a complete array of equipment are employed to assure a high level of confidence of each graduating student. Courses are offered from the beginner level to the more advanced level of instruction.

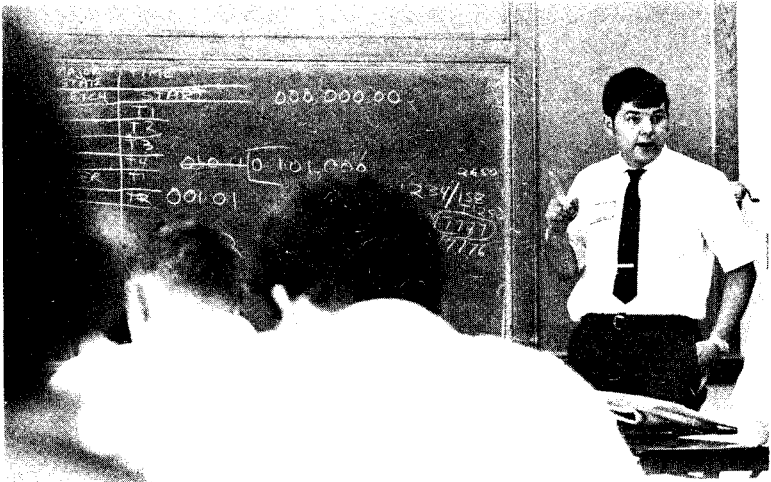

A hardware class goes through the logic with a timing breakdown.



Software students utilize lab periods with the computers to reinforce classroom learning.



One of the training laboratories—usually a very busy place.

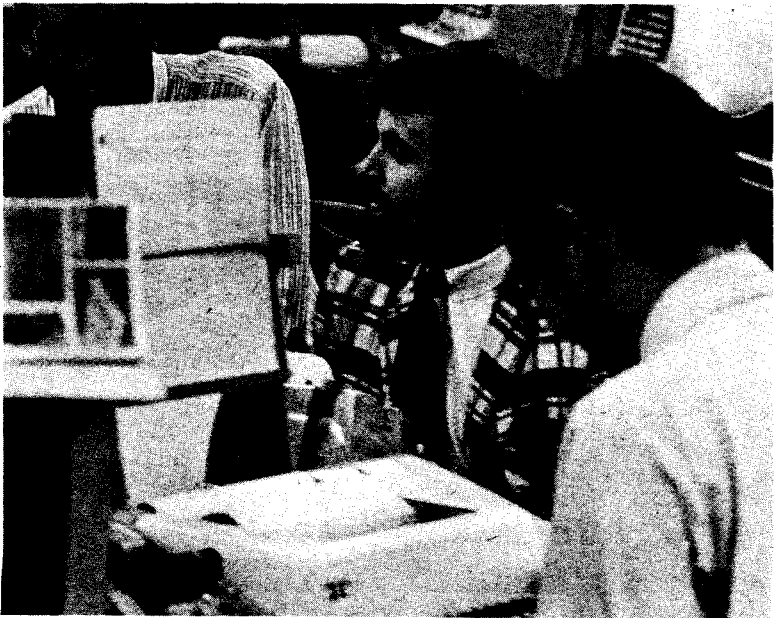

Happiness is—an assembled, edited program that works.



A peripheral class investigates the inner workings of one of our disk pack units.

REPAIR SERVICE

The key to maintaining your PDP-8/computer system is no further away than your telephone. Digital Equipment Corporation provides 113 service centers throughout the free world employing nearly 1000 trained engineers for repair and a complete range of technical assistance.



This field service engineer is not out to set the world's record on servicing a computer. However, like all field service engineers, he is fast, knowledgeable, professional, and courteous. It is men like him that give Digital Equipment Corporation "high marks" in field service.

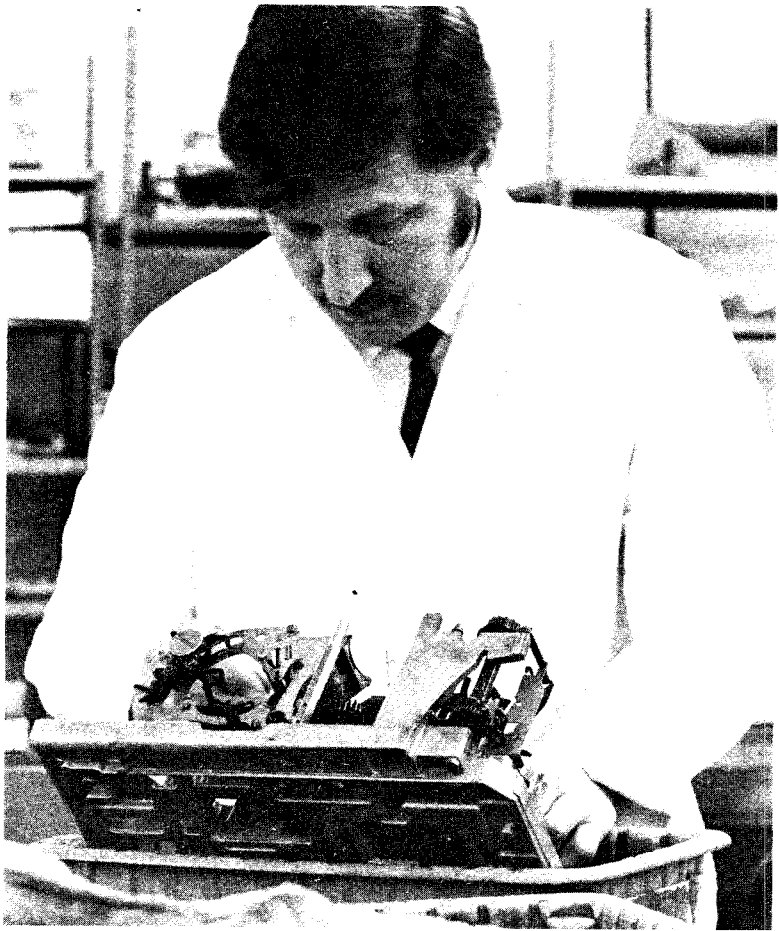

For Depot Repair Service

Depot repair service saves the customer money and time. If you operate on a tight budget . . . or if the DEC products you (or your customers) use are far from our service facilities—Digital's repair depots may be the most economical solution to your maintenance problems.

Depots provide cash-and-carry maintenance and repair service on Teletypes, computers, many standard options and peripherals. You save the cost of a service man's travel time and expense. DEC currently has depots in or near Boston, New York, Chicago, Houston, Los Angeles, San Francisco, Ottawa, Munich, and London. Other services provided at these depots include trading in your old equipment, converting your teletype or punch, etc.

MAINTENANCE CONTRACTS

The best method of assuring that your operating system is performing in peak condition all of the time is with a field service contract. With a DEC Field Service Contract, a highly trained engineer or technician will come in at regular intervals and perform carefully planned preventive maintenance to keep your PDP-8/E in top condition. Should your computer go down, you're sure to get prompt, expert service to set it right again. Everything you need to keep up your computer is yours for a fixed monthly charge, whether you need little more than a quick dusting of the keys or a complete overhaul. All contract customers are preferred on a service priority basis.



Customer Service Contracts Guarantee Continuous Operation

part**1**

BASIC SYSTEM

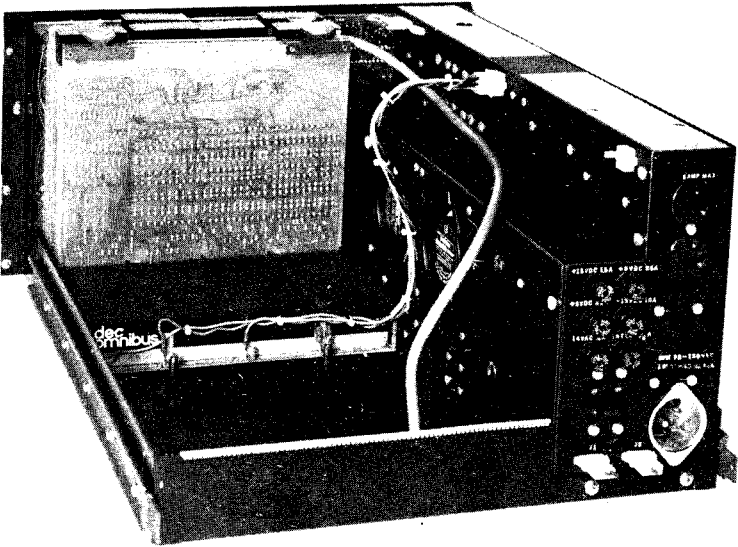

PDP-8/E Programmed Data Processor
(Table Model)