

NOTES:
 * USER MODE IS USED BY THE TIME SHARING OPTION ONLY; TO INHIBIT HALT, OSR, LAS, & PAUSE

QTY.	DESCRIPTION	PART NO.	ITEM NO.
	PDP8/E		
	PARTS LIST		
	EQUIPMENT CORPORATION		
	PROCESSOR FLOW CHART		
	EFD PDP8/E-0-06		

REV. 1	DATE	BY
REV. 2	DATE	BY
REV. 3	DATE	BY
REV. 4	DATE	BY
REV. 5	DATE	BY

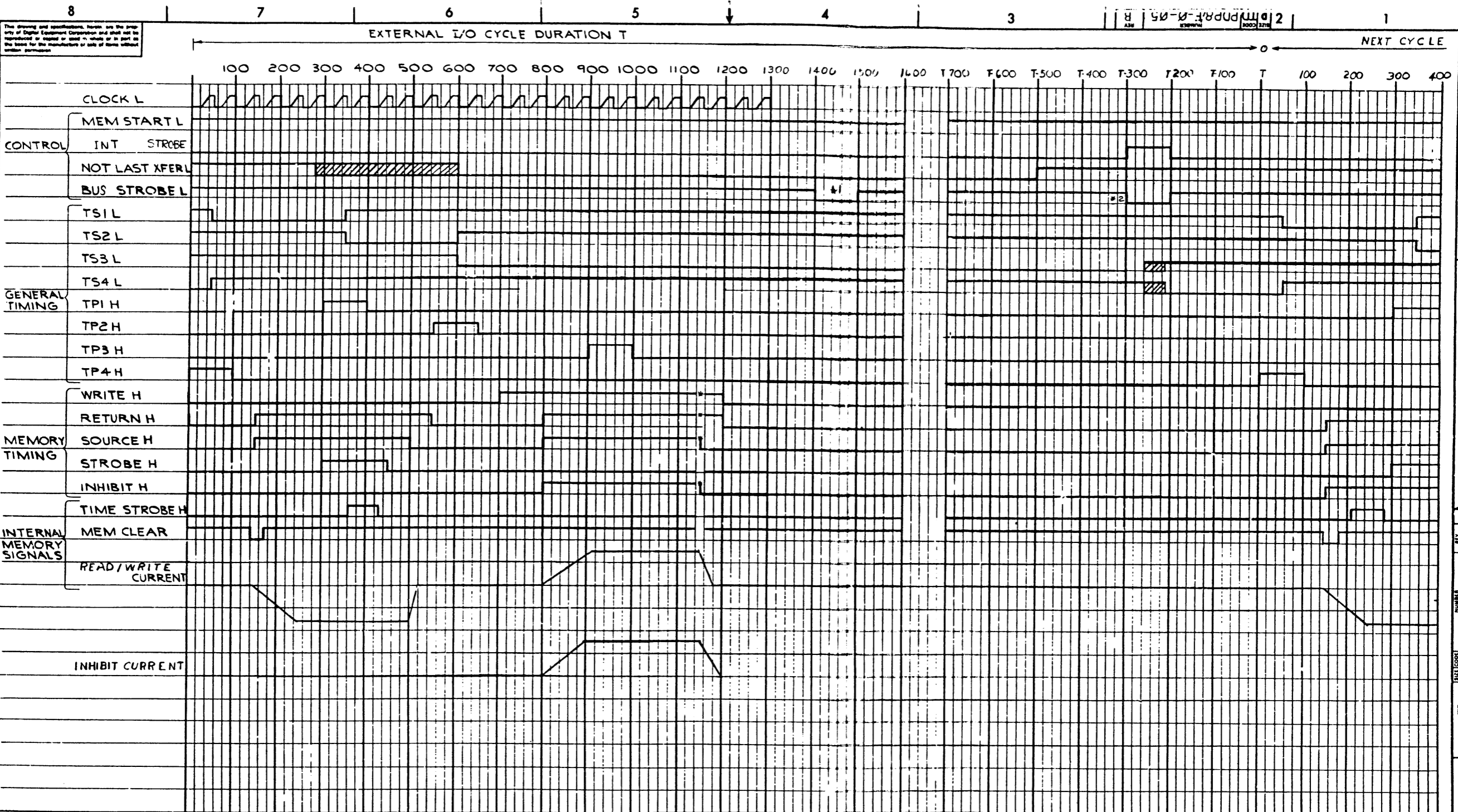

NOTE: * MEMORY SIGNALS TIME OUT, AS IN A FAST CYCLE
 * 1 GENERATED BY PERIPHERAL TO STROBE DATA
 * 2 GENERATED BY PERIPHERAL TO TERMINATE EXT. I/O CYCLE AND RESUME NORMAL OPERATION.

REV	
CHG	
CHK	

FIRST USED ON OPT/MOD PDP8/E	QTY.	DESCRIPTION	PART NO.	ITEM NO.
UNLESS OTHERWISE SPECIFIED DIMENSION IN INCHES TOLERANCES DECIMALS FRACTIONS ANGLES ± .005 ± .125 ± .075 FINAL SURFACE QUALITY REMOVE BURRS AND BREAK SHARP CORNERS	DATE 11/1/71	DATE 11/1/71	DATE 11/3/71	DATE 11/3/71
MATERIAL FINISH	PATTS LIST EQUIPMENT CORPORATION MAYNARD MASSACHUSETTS TITLE TIMING (PDP8/E) SIZE CODE D1TD NUMBER PDP8/E-0-05 REV. B			
SCALE NONE	A-ML-PDP8/E-0 SHEET 2 OF 2 DICT.			

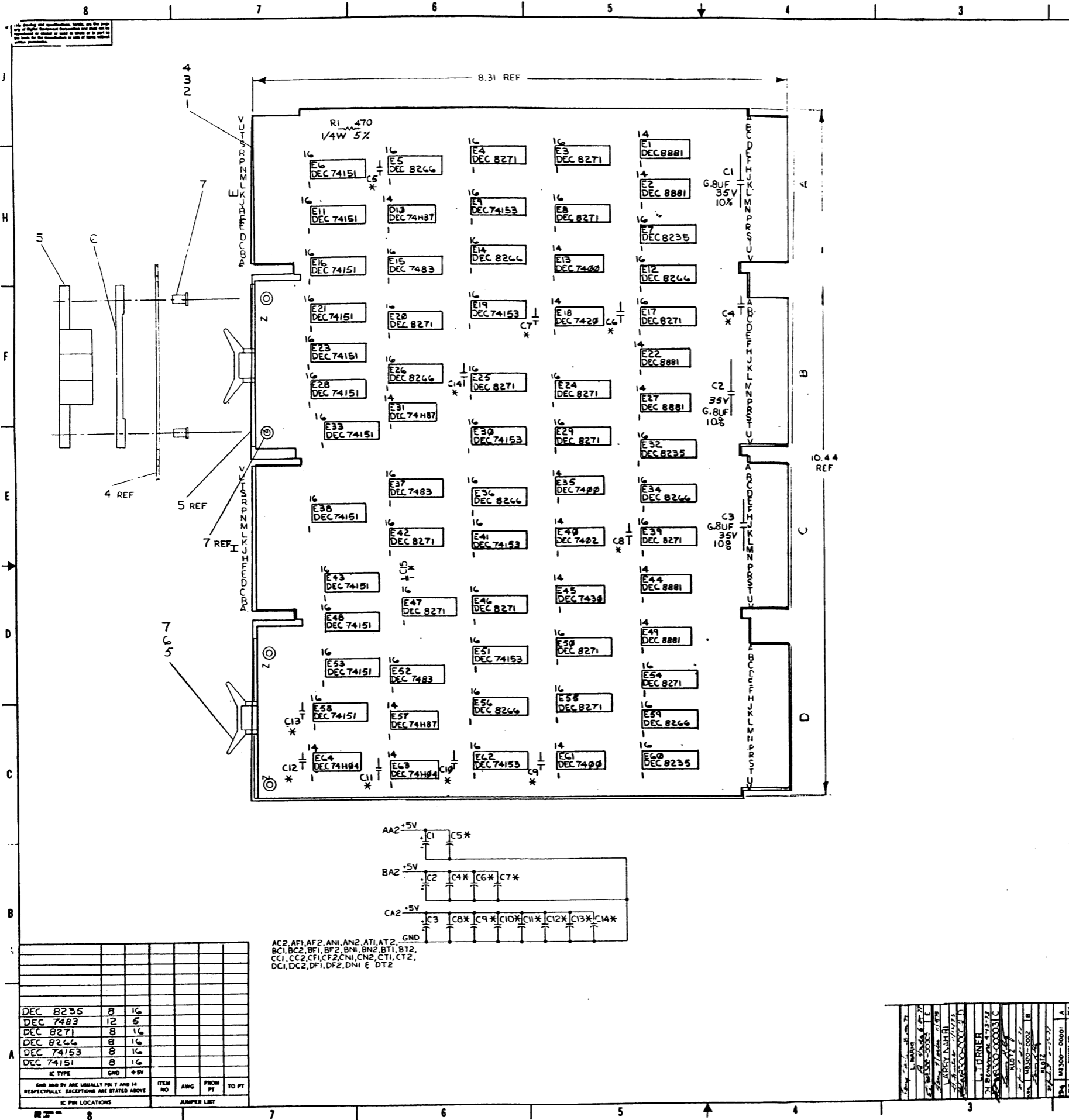

NOTES:
 * THESE COMPONENTS MUST BE ON MB300
 IF KLB-A (MB319) IS USED ON SYSTEM.

QTY.	REF DESIGNATION	DESCRIPTION	PART NO.	REV.
1	C15	CAP 100PF D.M.	1000016	25
6	E9, E19, E30, E41, E51, E62	I.C. DEC 74153	1909937	23
12	E6, E11, E16, E21, E23, E28, E33, E38, E43, E48, E53, E58	I.C. DEC 74151	1909936	22
3	E7, E32, E60	I.C. DEC 8235	1909935	21
8	E5, E12, E14, E26, E34, E36, E56, E59	I.C. DEC 8266	1909934	20
3	E15, E37, E52	I.C. DEC 7483	1909932	19
2	E63, E64	I.C. DEC 74404	1909931	18
3	E10, E31, E57	I.C. DEC 74H87	1909927	17
6	E12, E22, E27, E44, E49	I.C. DEC 8881	1909705	16
15	E24, E25, E29, E35, E40, E42, E43, E47, E49, E50, E54, E55	I.C. DEC 8271	1909615	15
1	E40	I.C. DEC 7402	1909004	14
1	E45	I.C. DEC 7430	1908578	13
1	E18	I.C. DEC 7400	1908577	12
3	E13, E35, E61	I.C. DEC 8266	1908575	11
11	C4 - C14	RESISTOR 470 1/4W 5%	100274-00	9
1	C1	CAP 22UF 50V CER	100274-00	9
3	C1, C2, C3	CAP G.BUF 35V 20X5TAN	1000002	8
4		EYELETS G54-11 STIMP	9006750	7
2		SPACER (CABLE CLAMP)	1202704	6
1		HANDLE FLIP CHIP MAGENTA	1008357	5
1		ETCHED CIRCUIT BOARD	1500485	4
REF		MODULE HISTORY LIST	84MH00000	3
REF		ASSY/DRILLING HOLE LAYOUT	84MH00000	2
REF		XY COORDINATE HOLE LOCK	84MH00000	1

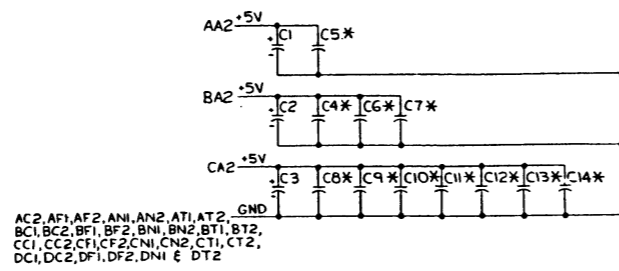

AC2, AF1, AF2, AN1, AN2, AT1, AT2,
 BC1, BC2, BF1, BF2, BN1, BN2, BT1, BT2,
 CC1, CC2, CF1, CF2, CN1, CN2, CT1, CT2,
 DC1, DC2, DF1, DF2, DN1 & DT2

IC TYPE	QTY	REF	PKG
DEC 8235	3	E7, E32, E60	16
DEC 7483	3	E15, E37, E52	16
DEC 8271	15	E24, E25, E29, E35, E40, E42, E43, E47, E49, E50, E54, E55	16
DEC 8266	8	E5, E12, E14, E26, E34, E36, E56, E59	16
DEC 74153	6	E9, E19, E30, E41, E51, E62	16
DEC 74151	12	E6, E11, E16, E21, E23, E28, E33, E38, E43, E48, E53, E58	16

REV	DATE	BY	CHKD	APP'D
1	11/14/71	W. J. TURNER		
2	11/15/71	W. J. TURNER		
3	11/15/71	W. J. TURNER		
4	11/15/71	W. J. TURNER		
5	11/15/71	W. J. TURNER		
6	11/15/71	W. J. TURNER		
7	11/15/71	W. J. TURNER		
8	11/15/71	W. J. TURNER		
9	11/15/71	W. J. TURNER		
10	11/15/71	W. J. TURNER		
11	11/15/71	W. J. TURNER		
12	11/15/71	W. J. TURNER		
13	11/15/71	W. J. TURNER		
14	11/15/71	W. J. TURNER		
15	11/15/71	W. J. TURNER		
16	11/15/71	W. J. TURNER		
17	11/15/71	W. J. TURNER		
18	11/15/71	W. J. TURNER		
19	11/15/71	W. J. TURNER		
20	11/15/71	W. J. TURNER		
21	11/15/71	W. J. TURNER		
22	11/15/71	W. J. TURNER		
23	11/15/71	W. J. TURNER		
24	11/15/71	W. J. TURNER		
25	11/15/71	W. J. TURNER		

PRINTED CIRCUIT BOARD REVISION
 CIRCUIT SCH REVISION
 TITLE: MAJOR REGISTERS (KK8/E)
 DEC NO. 0-0A-KK8-E-0
 SEMICONDUCTOR CONVERSION CHART
 SCALE 2/1
 SHEET 1 OF 5
 EICSI MB300-0-1
 REV. 15

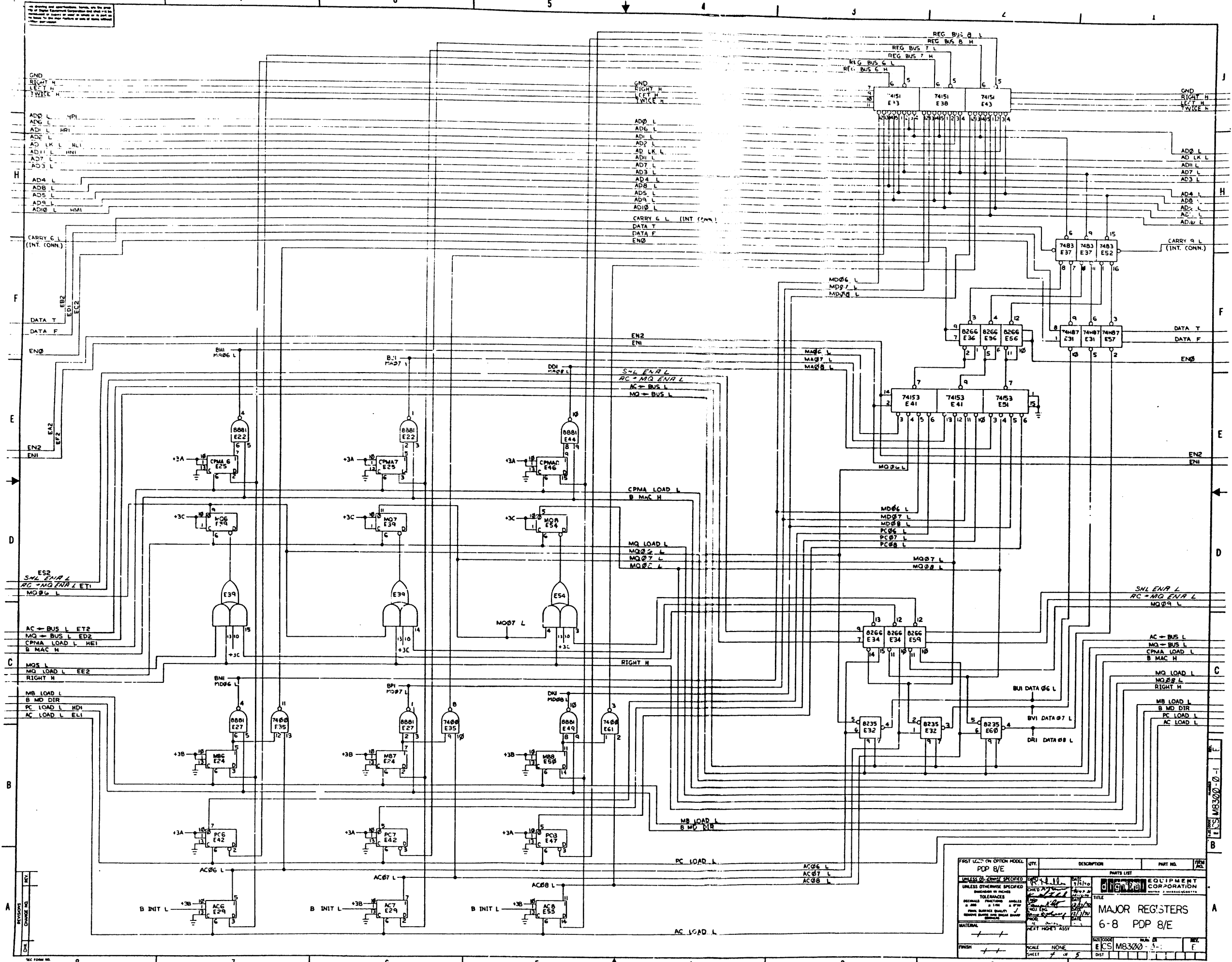

FIRST LETTER ON OPTION MODEL	QTY.	DESCRIPTION	PART NO.	REV.
PDP 8/E				
UNLESS OTHERWISE SPECIFIED				
DIMENSIONS IN INCHES				
TOLERANCES				
DECIMALS FRACTIONS ANGLES				
FINISH SURFACE QUALITY				
MATERIAL				
FINISH				
SCALE NONE				
SHEET 5 OF 5				
TITLE			PARTS LIST	
MAJOR REGISTERS			EQUIPMENT CORPORATION	
6-8 PDP 8/E			DATE 1/1/70	
DRAWN BY			CHECKED BY	
DATE 1/1/70			DATE 1/1/70	
NEXT TRIPLET ASSY			REV. 1	
SCALE NONE			REV. 1	
SHEET 5 OF 5			REV. 1	
EICS M8300-0-3-			REV. 1	
DIST			REV. 1	

EICS M8300-0-1

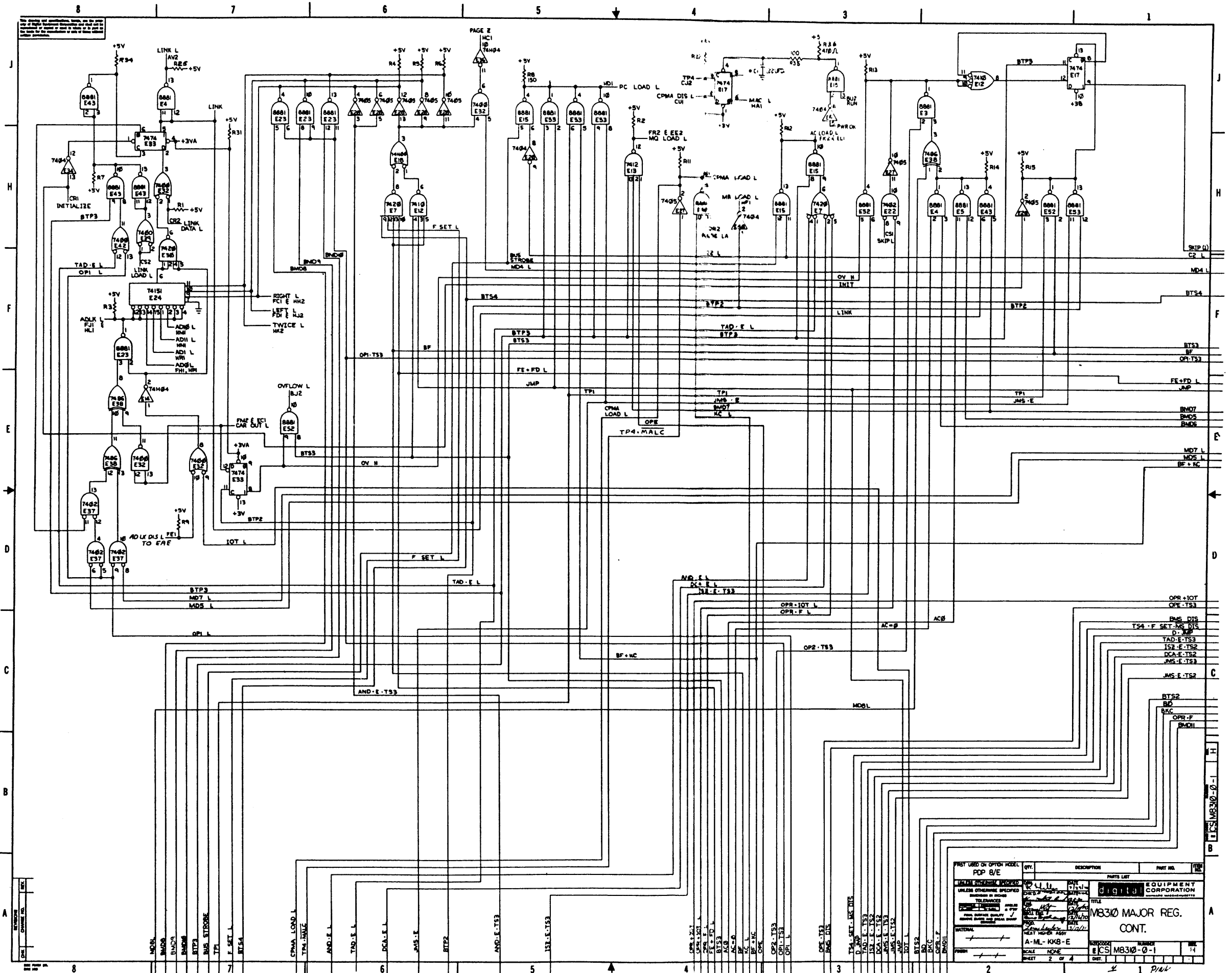

QTY.	DESCRIPTION	PART NO.	REV.
1	8881 E23	8881 E23	1
1	8881 E24	8881 E24	1
1	8881 E25	8881 E25	1
1	8881 E26	8881 E26	1
1	8881 E27	8881 E27	1
1	8881 E28	8881 E28	1
1	8881 E29	8881 E29	1
1	8881 E30	8881 E30	1
1	8881 E31	8881 E31	1
1	8881 E32	8881 E32	1
1	8881 E33	8881 E33	1
1	8881 E34	8881 E34	1
1	8881 E35	8881 E35	1
1	8881 E36	8881 E36	1
1	8881 E37	8881 E37	1
1	8881 E38	8881 E38	1
1	8881 E39	8881 E39	1
1	8881 E40	8881 E40	1
1	8881 E41	8881 E41	1
1	8881 E42	8881 E42	1
1	8881 E43	8881 E43	1
1	8881 E44	8881 E44	1
1	8881 E45	8881 E45	1
1	8881 E46	8881 E46	1
1	8881 E47	8881 E47	1
1	8881 E48	8881 E48	1
1	8881 E49	8881 E49	1
1	8881 E50	8881 E50	1
1	8881 E51	8881 E51	1
1	8881 E52	8881 E52	1
1	8881 E53	8881 E53	1
1	8881 E54	8881 E54	1
1	8881 E55	8881 E55	1
1	8881 E56	8881 E56	1
1	8881 E57	8881 E57	1
1	8881 E58	8881 E58	1
1	8881 E59	8881 E59	1
1	8881 E60	8881 E60	1
1	8881 E61	8881 E61	1
1	8881 E62	8881 E62	1
1	8881 E63	8881 E63	1
1	8881 E64	8881 E64	1
1	8881 E65	8881 E65	1
1	8881 E66	8881 E66	1
1	8881 E67	8881 E67	1
1	8881 E68	8881 E68	1
1	8881 E69	8881 E69	1
1	8881 E70	8881 E70	1
1	8881 E71	8881 E71	1
1	8881 E72	8881 E72	1
1	8881 E73	8881 E73	1
1	8881 E74	8881 E74	1
1	8881 E75	8881 E75	1
1	8881 E76	8881 E76	1
1	8881 E77	8881 E77	1
1	8881 E78	8881 E78	1
1	8881 E79	8881 E79	1
1	8881 E80	8881 E80	1
1	8881 E81	8881 E81	1
1	8881 E82	8881 E82	1
1	8881 E83	8881 E83	1
1	8881 E84	8881 E84	1
1	8881 E85	8881 E85	1
1	8881 E86	8881 E86	1
1	8881 E87	8881 E87	1
1	8881 E88	8881 E88	1
1	8881 E89	8881 E89	1
1	8881 E90	8881 E90	1
1	8881 E91	8881 E91	1
1	8881 E92	8881 E92	1
1	8881 E93	8881 E93	1
1	8881 E94	8881 E94	1
1	8881 E95	8881 E95	1
1	8881 E96	8881 E96	1
1	8881 E97	8881 E97	1
1	8881 E98	8881 E98	1
1	8881 E99	8881 E99	1
1	8881 E100	8881 E100	1

TITLE: MB310 MAJOR REG. CONT.
 DRAWING NO.: MB310-0-1
 SHEET: 2 OF 4
 DATE: 1/14/64
 DESIGNED BY: [Signature]
 CHECKED BY: [Signature]
 APPROVED BY: [Signature]
 MATERIAL: [Blank]
 FINISH: [Blank]

- NOTES:
- UNLESS OTHERWISE SPECIFIED:
CAPACITORS = .047UF 16V 15-20%
RESISTORS = 1500 1/4W 5%
DIODES = D664
 - CONNECT ALL PINS C, F, N, T (EXCEPT AC1)
TOGETHER TO GROUND.
 - ITEM NO. B (D664) MAY BE REPLACED WITH D600
P.N. 1105366 (REV C ONLY).
 - INSTALL ITEM 25 (TUBING) ON BASE LEAD OF
EACH 2N3725.
 - ANY COLOR TUBING MAY BE USED FOR ITEM 25.

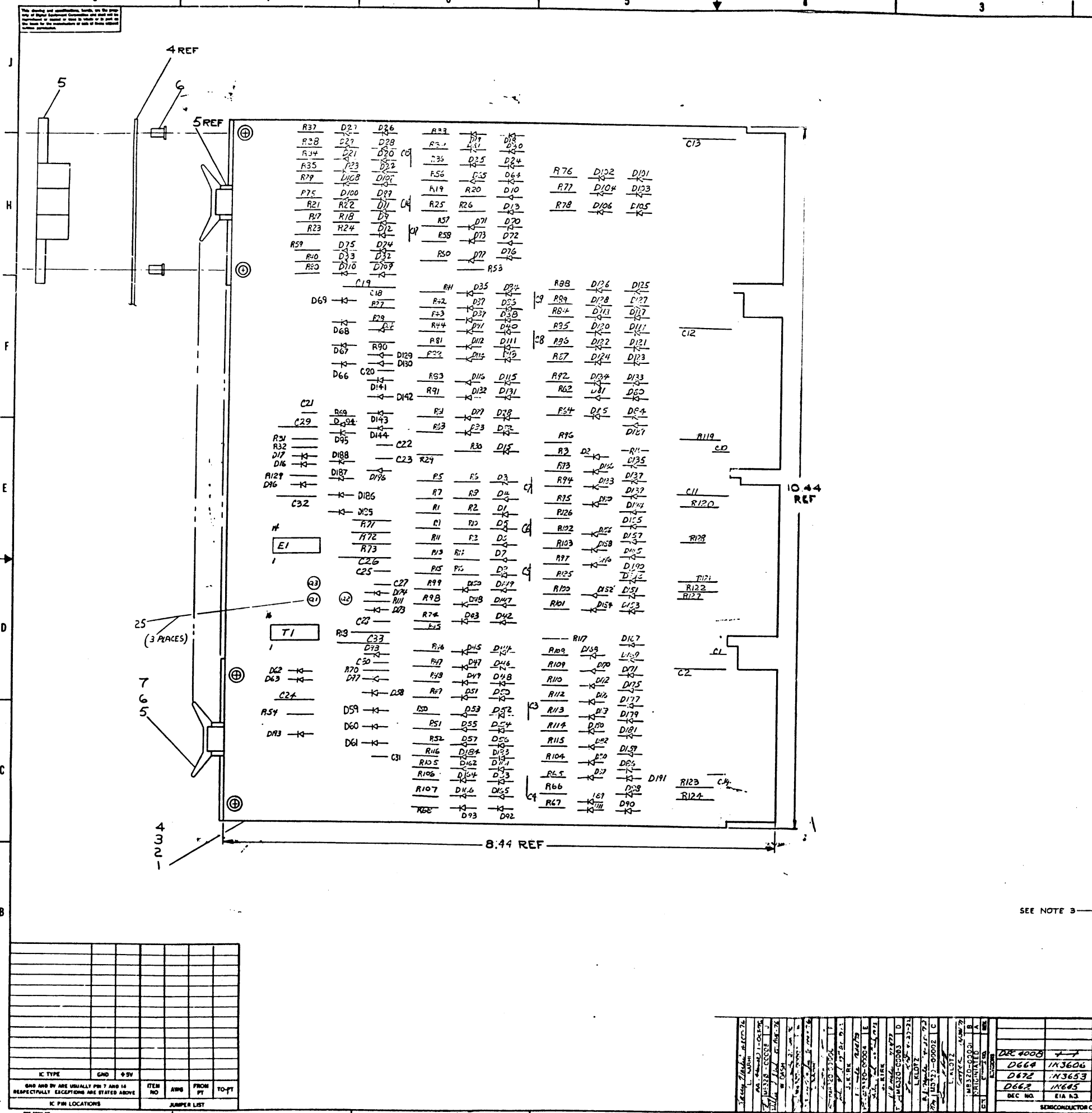

A/R	TUBING, 22 AWG	9107256-11	25
3	TRANS 2N3725	1510959	24
12	RES 1K 1/4 W 5%	1300365	23
14	GRIPLET	1210244-0	22
3	C24, C29, C32	CAP 330PF 100V 5%	1000023
7	C8, C11, C12, C13, C19, C26, C33	CAP 6.8UF 35V 20%	1000067
23	C13-C10, C14-C18, C20-C23, C25, C27, C28, C30, C31	CAP .047UF 16V 15-20%	1009678
1	E1	IC DEC 7400	195875
17	R152-R158	RES 1/2W 10% GOODWILL LINE	1609651
17	R159-R165	RES 1/4W 10% GOODWILL	1510015
6	R119-R124	RES 1K 1/4W 10%	1302187
4	R71-R73, R118	RES 12K 1/2W 10%	1300387
46	R53, R69, R74-R77	RES 1500 1/4W 5%	1300391
40	R24, R26, R28, R31, R32, R34, R36, R38, R40, R42, R44, R46, R48, R50, R52, R54, R56, R58, R60, R62, R64, R66, R68, R70, R72, R74, R76, R78, R80, R82, R84, R86, R88, R90, R92, R94, R96, R98, R100, R102, R104, R106, R108, R110, R112, R114, R116, R118, R120, R122, R124, R126, R128, R130, R132, R134, R136, R138, R140, R142, R144, R146, R148, R150, R152, R154, R156, R158, R160, R162, R164, R166, R168, R170, R172, R174, R176, R178, R180, R182, R184, R186, R188, R190, R192, R194, R196, R198, R200, R202, R204, R206, R208, R210, R212, R214, R216, R218, R220, R222, R224, R226, R228, R230, R232, R234, R236, R238, R240, R242, R244, R246, R248, R250, R252, R254, R256, R258, R260, R262, R264, R266, R268, R270, R272, R274, R276, R278, R280, R282, R284, R286, R288, R290, R292, R294, R296, R298, R300, R302, R304, R306, R308, R310, R312, R314, R316, R318, R320, R322, R324, R326, R328, R330, R332, R334, R336, R338, R340, R342, R344, R346, R348, R350, R352, R354, R356, R358, R360, R362, R364, R366, R368, R370, R372, R374, R376, R378, R380, R382, R384, R386, R388, R390, R392, R394, R396, R398, R400, R402, R404, R406, R408, R410, R412, R414, R416, R418, R420, R422, R424, R426, R428, R430, R432, R434, R436, R438, R440, R442, R444, R446, R448, R450, R452, R454, R456, R458, R460, R462, R464, R466, R468, R470, R472, R474, R476, R478, R480, R482, R484, R486, R488, R490, R492, R494, R496, R498, R500, R502, R504, R506, R508, R510, R512, R514, R516, R518, R520, R522, R524, R526, R528, R530, R532, R534, R536, R538, R540, R542, R544, R546, R548, R550, R552, R554, R556, R558, R560, R562, R564, R566, R568, R570, R572, R574, R576, R578, R580, R582, R584, R586, R588, R590, R592, R594, R596, R598, R600, R602, R604, R606, R608, R610, R612, R614, R616, R618, R620, R622, R624, R626, R628, R630, R632, R634, R636, R638, R640, R642, R644, R646, R648, R650, R652, R654, R656, R658, R660, R662, R664, R666, R668, R670, R672, R674, R676, R678, R680, R682, R684, R686, R688, R690, R692, R694, R696, R698, R700, R702, R704, R706, R708, R710, R712, R714, R716, R718, R720, R722, R724, R726, R728, R730, R732, R734, R736, R738, R740, R742, R744, R746, R748, R750, R752, R754, R756, R758, R760, R762, R764, R766, R768, R770, R772, R774, R776, R778, R780, R782, R784, R786, R788, R790, R792, R794, R796, R798, R800, R802, R804, R806, R808, R810, R812, R814, R816, R818, R820, R822, R824, R826, R828, R830, R832, R834, R836, R838, R840, R842, R844, R846, R848, R850, R852, R854, R856, R858, R860, R862, R864, R866, R868, R870, R872, R874, R876, R878, R880, R882, R884, R886, R888, R890, R892, R894, R896, R898, R900, R902, R904, R906, R908, R910, R912, R914, R916, R918, R920, R922, R924, R926, R928, R930, R932, R934, R936, R938, R940, R942, R944, R946, R948, R950, R952, R954, R956, R958, R960, R962, R964, R966, R968, R970, R972, R974, R976, R978, R980, R982, R984, R986, R988, R990, R992, R994, R996, R998, R1000, R1002, R1004, R1006, R1008, R1010, R1012, R1014, R1016, R1018, R1020, R1022, R1024, R1026, R1028, R1030, R1032, R1034, R1036, R1038, R1040, R1042, R1044, R1046, R1048, R1050, R1052, R1054, R1056, R1058, R1060, R1062, R1064, R1066, R1068, R1070, R1072, R1074, R1076, R1078, R1080, R1082, R1084, R1086, R1088, R1090, R1092, R1094, R1096, R1098, R1100, R1102, R1104, R1106, R1108, R1110, R1112, R1114, R1116, R1118, R1120, R1122, R1124, R1126, R1128, R1130, R1132, R1134, R1136, R1138, R1140, R1142, R1144, R1146, R1148, R1150, R1152, R1154, R1156, R1158, R1160, R1162, R1164, R1166, R1168, R1170, R1172, R1174, R1176, R1178, R1180, R1182, R1184, R1186, R1188, R1190, R1192, R1194, R1196, R1198, R1200, R1202, R1204, R1206, R1208, R1210, R1212, R1214, R1216, R1218, R1220, R1222, R1224, R1226, R1228, R1230, R1232, R1234, R1236, R1238, R1240, R1242, R1244, R1246, R1248, R1250, R1252, R1254, R1256, R1258, R1260, R1262, R1264, R1266, R1268, R1270, R1272, R1274, R1276, R1278, R1280, R1282, R1284, R1286, R1288, R1290, R1292, R1294, R1296, R1298, R1300, R1302, R1304, R1306, R1308, R1310, R1312, R1314, R1316, R1318, R1320, R1322, R1324, R1326, R1328, R1330, R1332, R1334, R1336, R1338, R1340, R1342, R1344, R1346, R1348, R1350, R1352, R1354, R1356, R1358, R1360, R1362, R1364, R1366, R1368, R1370, R1372, R1374, R1376, R1378, R1380, R1382, R1384, R1386, R1388, R1390, R1392, R1394, R1396, R1398, R1400, R1402, R1404, R1406, R1408, R1410, R1412, R1414, R1416, R1418, R1420, R1422, R1424, R1426, R1428, R1430, R1432, R1434, R1436, R1438, R1440, R1442, R1444, R1446, R1448, R1450, R1452, R1454, R1456, R1458, R1460, R1462, R1464, R1466, R1468, R1470, R1472, R1474, R1476, R1478, R1480, R1482, R1484, R1486, R1488, R1490, R1492, R1494, R1496, R1498, R1500, R1502, R1504, R1506, R1508, R1510, R1512, R1514, R1516, R1518, R1520, R1522, R1524, R1526, R1528, R1530, R1532, R1534, R1536, R1538, R1540, R1542, R1544, R1546, R1548, R1550, R1552, R1554, R1556, R1558, R1560, R1562, R1564, R1566, R1568, R1570, R1572, R1574, R1576, R1578, R1580, R1582, R1584, R1586, R1588, R1590, R1592, R1594, R1596, R1598, R1600, R1602, R1604, R1606, R1608, R1610, R1612, R1614, R1616, R1618, R1620, R1622, R1624, R1626, R1628, R1630, R1632, R1634, R1636, R1638, R1640, R1642, R1644, R1646, R1648, R1650, R1652, R1654, R1656, R1658, R1660, R1662, R1664, R1666, R1668, R1670, R1672, R1674, R1676, R1678, R1680, R1682, R1684, R1686, R1688, R1690, R1692, R1694, R1696, R1698, R1700, R1702, R1704, R1706, R1708, R1710, R1712, R1714, R1716, R1718, R1720, R1722, R1724, R1726, R1728, R1730, R1732, R1734, R1736, R1738, R1740, R1742, R1744, R1746, R1748, R1750, R1752, R1754, R1756, R1758, R1760, R1762, R1764, R1766, R1768, R1770, R1772, R1774, R1776, R1778, R1780, R1782, R1784, R1786, R1788, R1790, R1792, R1794, R1796, R1798, R1800, R1802, R1804, R1806, R1808, R1810, R1812, R1814, R1816, R1818, R1820, R1822, R1824, R1826, R1828, R1830, R1832, R1834, R1836, R1838, R1840, R1842, R1844, R1846, R1848, R1850, R1852, R1854, R1856, R1858, R1860, R1862, R1864, R1866, R1868, R1870, R1872, R1874, R1876, R1878, R1880, R1882, R1884, R1886, R1888, R1890, R1892, R1894, R1896, R1898, R1900, R1902, R1904, R1906, R1908, R1910, R1912, R1914, R1916, R1918, R1920, R1922, R1924, R1926, R1928, R1930, R1932, R1934, R1936, R1938, R1940, R1942, R1944, R1946, R1948, R1950, R1952, R1954, R1956, R1958, R1960, R1962, R1964, R1966, R1968, R1970, R1972, R1974, R1976, R1978, R1980, R1982, R1984, R1986, R1988, R1990, R1992, R1994, R1996, R1998, R2000, R2002, R2004, R2006, R2008, R2010, R2012, R2014, R2016, R2018, R2020, R2022, R2024, R2026, R2028, R2030, R2032, R2034, R2036, R2038, R2040, R2042, R2044, R2046, R2048, R2050, R2052, R2054, R2056, R2058, R2060, R2062, R2064, R2066, R2068, R2070, R2072, R2074, R2076, R2078, R2080, R2082, R2084, R2086, R2088, R2090, R2092, R2094, R2096, R2098, R2100, R2102, R2104, R2106, R2108, R2110, R2112, R2114, R2116, R2118, R2120, R2122, R2124, R2126, R2128, R2130, R2132, R2134, R2136, R2138, R2140, R2142, R2144, R2146, R2148, R2150, R2152, R2154, R2156, R2158, R2160, R2162, R2164, R2166, R2168, R2170, R2172, R2174, R2176, R2178, R2180, R2182, R2184, R2186, R2188, R2190, R2192, R2194, R2196, R2198, R2200, R2202, R2204, R2206, R2208, R2210, R2212, R2214, R2216, R2218, R2220, R2222, R2224, R2226, R2228, R2230, R2232, R2234, R2236, R2238, R2240, R2242, R2244, R2246, R2248, R2250, R2252, R2254, R2256, R2258, R2260, R2262, R2264, R2266, R2268, R2270, R2272, R2274, R2276, R2278, R2280, R2282, R2284, R2286, R2288, R2290, R2292, R2294, R2296, R2298, R2300, R2302, R2304, R2306, R2308, R2310, R2312, R2314, R2316, R2318, R2320, R2322, R2324, R2326, R2328, R2330, R2332, R2334, R2336, R2338, R2340, R2342, R2344, R2346, R2348, R2350, R2352, R2354, R2356, R2358, R2360, R2362, R2364, R2366, R2368, R2370, R2372, R2374, R2376, R2378, R2380, R2382, R2384, R2386, R2388, R2390, R2392, R2394, R2396, R2398, R2400, R2402, R2404, R2406, R2408, R2410, R2412, R2414, R2416, R2418, R2420, R2422, R2424, R2426, R2428, R2430, R2432, R2434, R2436, R2438, R2440, R2442, R2444, R2446, R2448, R2450, R2452, R2454, R2456, R2458, R2460, R2462, R2464, R2466, R2468, R2470, R2472, R2474, R2476, R2478, R2480, R2482, R2484, R2486, R2488, R2490, R2492, R2494, R2496, R2498, R2500, R2502, R2504, R2506, R2508, R2510, R2512, R2514, R2516, R2518, R2520, R2522, R2524, R2526, R2528, R2530, R2532, R2534, R2536, R2538, R2540, R2542, R2544, R2546, R2548, R2550, R2552, R2554, R2556, R2558, R2560, R2562, R2564, R2566, R2568, R2570, R2572, R2574, R2576, R2578, R2580, R2582, R2584, R2586, R2588, R2590, R2592, R2594, R2596, R2598, R2600, R2602, R2604, R2606, R2608, R2610, R2612, R2614, R2616, R2618, R2620, R2622, R2624, R2626, R2628, R2630, R2632, R2634, R2636, R2638, R2640, R2642, R2644, R2646, R2648, R2650, R2652, R2654, R2656, R2658, R2660, R2662, R2664, R2666, R2668, R2670, R2672, R2674, R2676, R2678, R2680, R2682, R2684, R2686, R2688, R2690, R2692, R2694, R2696, R2698, R2700, R2702, R2704, R2706, R2708, R2710, R2712, R2714, R2716, R2718, R2720, R2722, R2724, R2726, R2728, R2730, R2732, R2734, R2736, R2738, R2740, R2742, R2744, R2746, R2748, R2750, R2752, R2754, R2756, R2758, R2760, R2762, R2764, R2766, R2768, R2770, R2772, R2774, R2776, R2778, R2780, R2782, R2784, R2786, R2788, R2790, R2792, R2794, R2796, R2798, R2800, R2802, R2804, R2806, R2808, R2810, R2812, R2814, R2816, R2818, R2820, R2822, R2824, R2826, R2828, R2830, R2832, R2834, R2836, R2838, R2840, R2842, R2844, R2846, R2848, R2850, R2852, R2854, R2856, R2858, R2860, R2862, R2864, R2866, R2868, R2870, R2872, R2874, R2876, R2878, R2880, R2882, R2884, R2886, R2888, R2890, R2892, R2894, R2896, R2898, R2900, R2902, R2904, R2906, R2908, R2910, R2912, R2914, R2916, R2918, R2920, R2922, R2924, R2926, R2928, R2930, R2932, R2934, R2936, R2938, R2940, R2942, R2944, R2946, R2948, R2950, R2952, R2954, R2956, R2958, R2960, R2962, R2964, R2966, R2968, R2970, R2972, R2974, R2976, R2978, R2980, R2982, R2984, R2986, R2988, R2990, R2992, R2994, R2996, R2998, R3000, R3002, R3004, R3006, R3008, R3010, R3012, R3014, R3016, R3018, R3020, R3022, R3024, R3026, R3028, R3030, R3032, R3034, R3036, R3038, R3040, R3042, R3044, R3046, R3048, R3050, R3052, R3054, R3056, R3058, R3060, R3062, R3064, R3066, R3068, R3070, R3072, R3074, R3076, R3078, R3080, R3082, R3084, R3086, R3088, R3090, R3092, R3094, R3096, R3098, R3100, R3102, R3104, R3106, R3108, R3110, R3112, R3114, R3116, R3118, R3120, R3122, R3124, R3126, R3128, R3130, R3132, R3134, R3136, R3138, R3140, R3142, R3144, R3146, R3148, R3150, R3152, R3154, R3156, R3158, R3160, R3162, R3164, R3166, R3168, R3170, R3172, R3174, R3176, R3178, R3180, R3182, R3184, R3186, R3188, R3190, R3192, R3194, R3196, R3198, R3200, R3202, R3204, R3206, R3208, R3210, R3212, R3214, R3216, R3218, R3220, R3222, R3224, R3226, R3228, R3230, R3232, R3234, R3236, R3238, R3240, R3242, R3244, R3246, R3248, R3250, R3252, R3254, R3256, R3258, R3260, R3262, R3264, R3266, R3268, R3270, R3272, R3274, R3276, R3278, R3280, R3282, R3284, R3286, R3288, R3290, R3292, R3294, R3296, R3298, R3300, R3302, R3304, R3306, R3308, R3310, R3312, R3314, R3316, R3318, R3320, R3322, R3324, R3326, R3328, R3330, R3332, R3334, R3336, R3338, R3340, R3342, R3344, R3346, R3348, R3350, R3352, R3354, R3356, R3358, R3360, R3362, R3364, R3366, R3368, R3370, R3372, R3374, R3376, R3378, R3380, R3382, R3384, R3386, R3388, R3390, R3392, R3394, R3396, R3398, R3400, R3402, R3404, R3406, R3408, R3410, R3412, R3414, R3416, R3418, R3420, R3422, R3424, R3426, R3428, R3430, R3432, R3434, R3436, R3438, R3440, R3442, R3444, R3446, R3448, R3450, R3452, R3454, R3456, R3458, R3460, R3462, R3464, R3466, R3468, R3470, R3472, R3474, R3476, R3478, R3480, R3482, R3484, R3486, R3488, R3490, R3492, R3494, R3496, R3498, R3500, R3502, R3504, R3506, R3508, R3510, R3512, R3514, R3516, R3518, R3520, R3522, R3524, R3526, R3528, R3530, R3532, R3534, R3536, R3538, R3540, R3542, R3544, R3546, R3548, R3550, R3552, R3554, R3556, R3558, R3560, R3562, R3564, R3566, R3568, R3570, R3572, R3574, R3576, R3578, R3580, R3582, R3584, R3586, R3588, R3590, R3592, R3594, R3596, R3598, R3600, R3602, R3604, R3606, R3608, R3610, R3612, R3614, R3616, R3618, R3620, R3622, R3624, R3626, R3628, R3630, R3632, R3634, R3636, R3638, R3640, R3642, R3644, R3646, R3648, R3650, R3652, R3654, R3656, R3658, R3660, R3662, R3664, R3666, R3668, R3670, R3672, R3674, R3676, R3678, R3680, R3682, R3684, R3686, R3688, R3690, R3692, R3694, R3696, R3698, R3700, R3702, R3704, R3706, R3708, R3710, R3712, R3714, R3716, R3718, R3720, R3722, R3724, R3726, R3728, R3730, R3732, R3734, R3736, R3738, R3740, R3742, R3744, R3746, R3748, R3750, R3752, R3754, R3756, R3758, R3760, R3762, R3764, R3766, R3768, R3770, R3772, R3774, R3776, R3778, R3780, R3782, R3784, R3786, R3788, R3790, R3792, R3794, R3796, R3798, R3800, R3802, R3804, R3806, R3808, R3810, R3812, R3814, R3816, R3818, R3820, R3822, R3824, R3826, R3828, R3830, R3832, R3834, R3836, R3838, R3840, R3842, R3844, R3846, R3848, R3850, R3852, R3854, R3856, R3858, R3860, R3862, R3864, R3866, R3868, R3870, R3872, R3874, R3876, R3878, R3880, R3882, R3884, R3886, R3888, R3890, R3892, R3894, R3896, R3898, R3900, R3902, R3904, R3906, R3908, R3910, R3912		

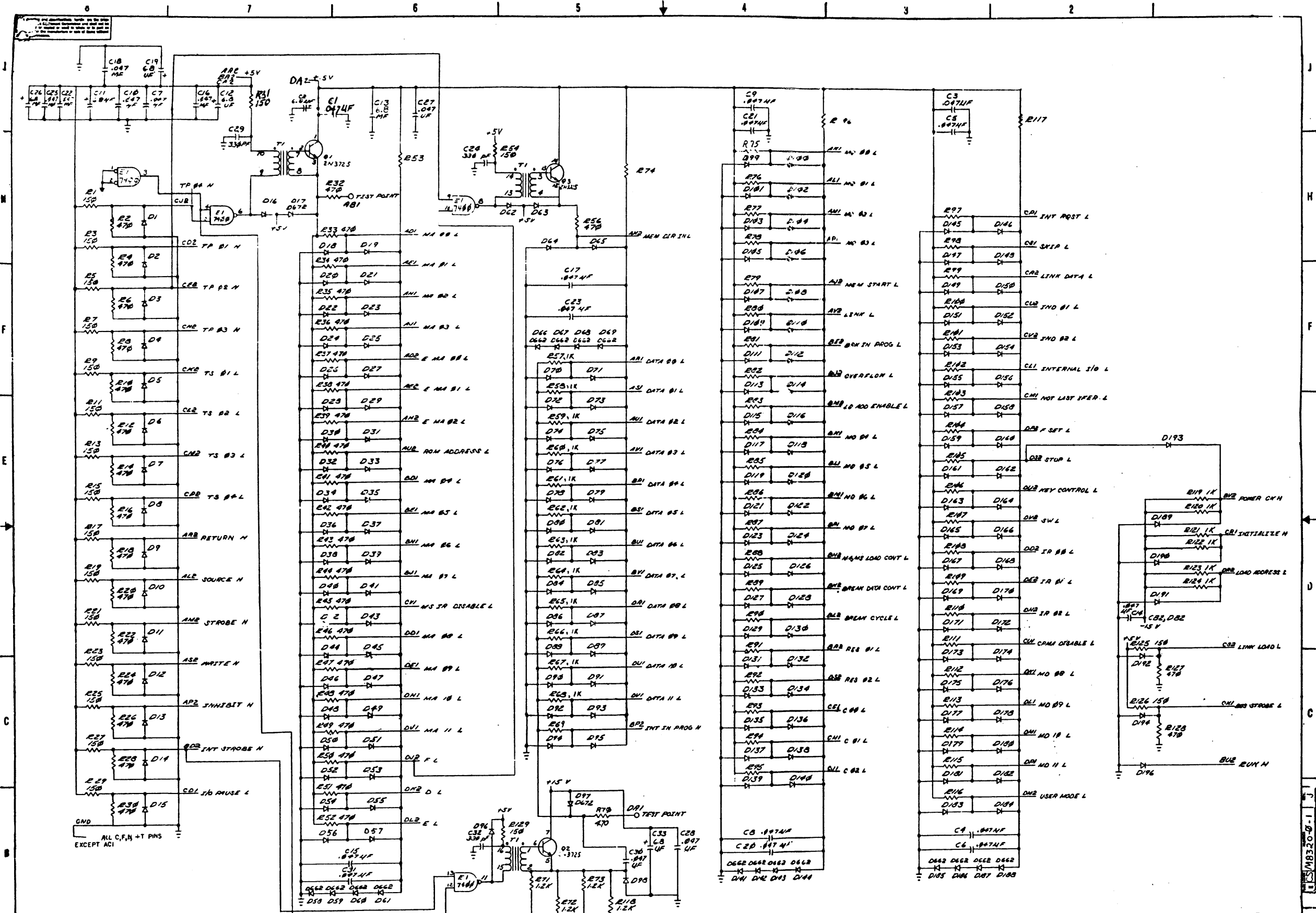

REV.	DESCRIPTION	DATE	BY	CHECKED	DATE	BY	DESCRIPTION	PART NO.	ITEM
1	REVISED	1-25-79	BUS LOADS	EKS MB320-D-1	J
2

EKS MB320-D-1 J

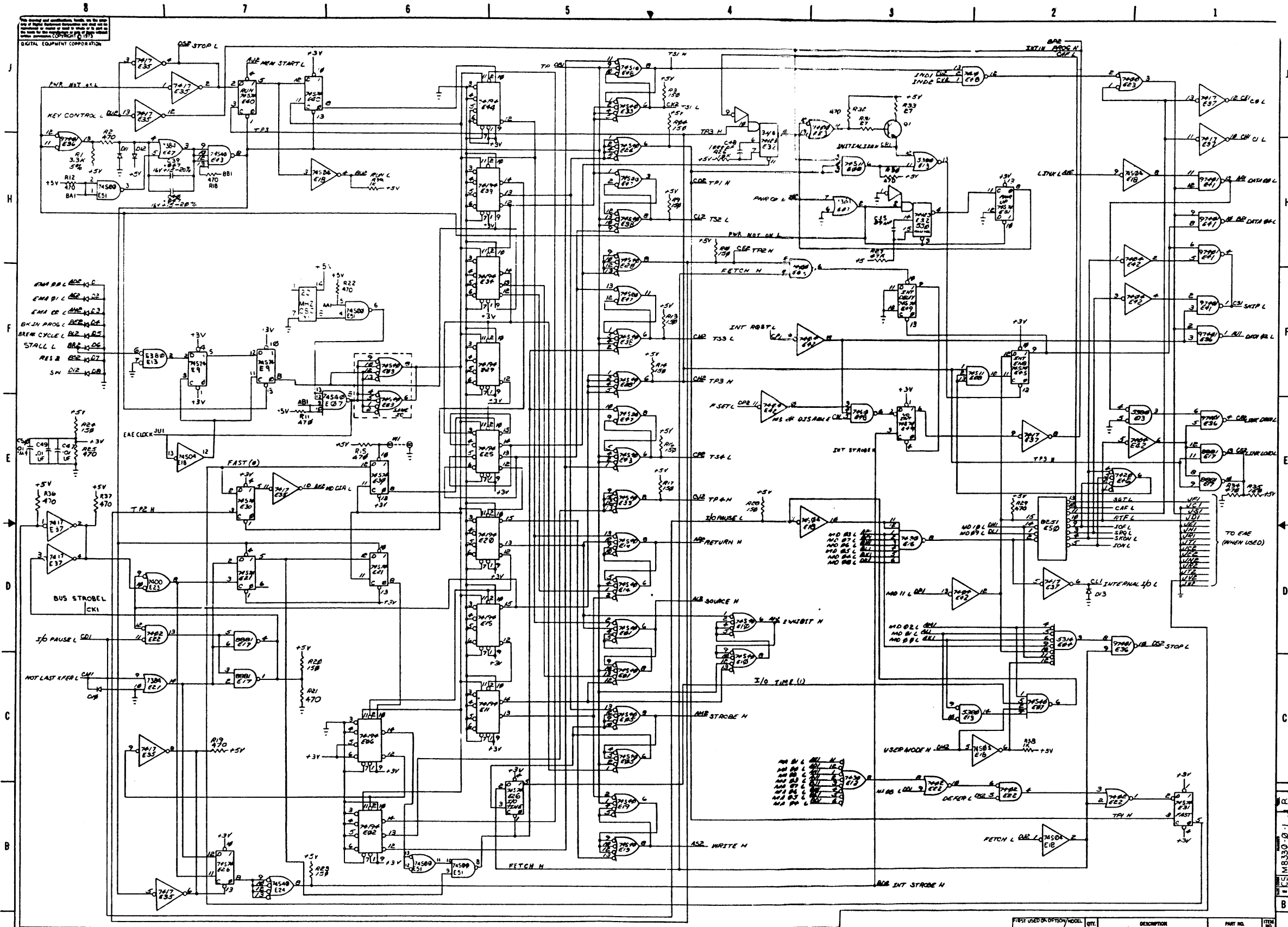

REV	DATE	DESCRIPTION	BY	CHKD
1				
2				
3				
4				
5				
6				
7				
8				
9				
10				
11				
12				
13				
14				
15				
16				
17				
18				
19				
20				
21				
22				
23				
24				
25				
26				
27				
28				
29				
30				
31				
32				
33				
34				
35				
36				
37				
38				
39				
40				
41				
42				
43				
44				
45				
46				
47				
48				
49				
50				
51				
52				
53				
54				
55				
56				
57				
58				
59				
60				
61				
62				
63				
64				
65				
66				
67				
68				
69				
70				
71				
72				
73				
74				
75				
76				
77				
78				
79				
80				
81				
82				
83				
84				
85				
86				
87				
88				
89				
90				
91				
92				
93				
94				
95				
96				
97				
98				
99				
100				

digital EQUIPMENT CORPORATION
 TITLE: TIMING GENERATOR
 PART NO. MB330-01
 REV. R

ECS MB330-01