

REV. C
 NUMBER M405-0-1
 CS B
 SIZE 3215

THIS SCHEMATIC IS FURNISHED ONLY FOR TEST AND MAINTENANCE PURPOSES. THE CIRCUITS ARE PROPRIETARY IN NATURE AND SHOULD BE TREATED ACCORDINGLY. COPYRIGHT 1968 BY DIGITAL EQUIPMENT CORPORATION

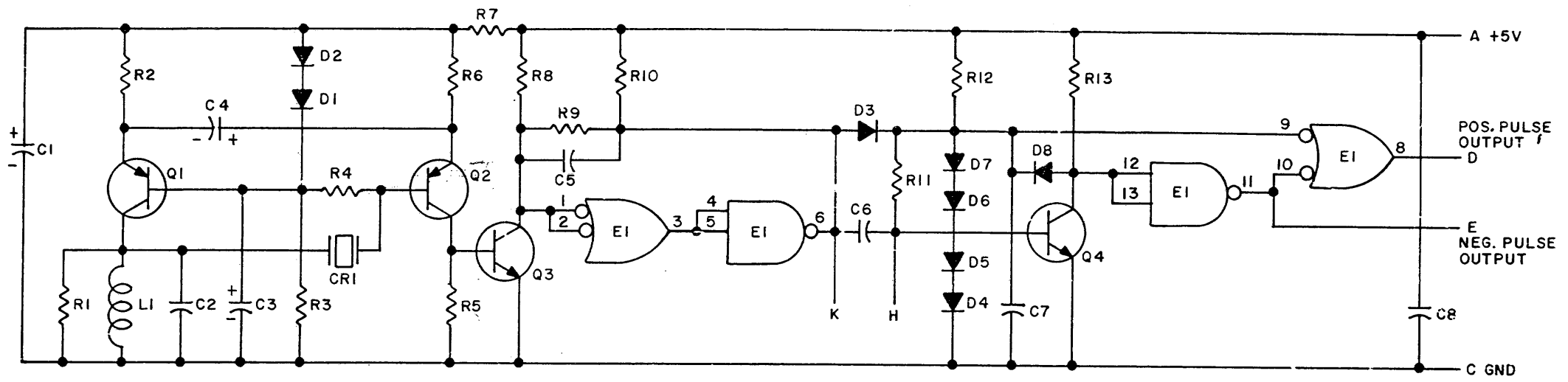

NOTES:
 1. PIN 14 ON IC = +5V
 2. PIN 7 ON IC = GND
 3. FOR VALUES OF C2, L1, CRI SEE DWG. CHART A-00517-2

R11, R12	RES. 390 1/4W 5% CC	1300309
C6	CAP. 120 MMF 100V 5% D.M.	1000018
L1, C2, CRI	SEE NOTE 3	
E1	INTEGRATED CKT. DEC7400N	1905575
Q3, Q4	TRANSISTOR DEC4274	1505302
Q1, Q2	TRANSISTOR DEC4258	1505321
R7	RES. 100 1/4W 10% CC	1300231
R4	RES. 100K 1/4W 10% CC	1300534
R3, R8, R10, R13	RES. 1K 1/4W 5% CC	1300365
R2, R5, R6, R9	RES. 2.2K 1/4W 10% CC	1300418
R1	RES. 10K 1/4W 10% CC	1300481
D3, D8	DIODE D664	1100114
D1, D2, D4-D7	DIODE D662	1100113
C7, C8	CAP. .01MFD 100V 20% DISC	1001610
C5	CAP. 47 MMF 100V 5% D.M.	1000011
C1, C3, C4	CAP. 39 MFD 10V 10% S.TANT	1000076
PARTS LIST		A-PL-M405-0-0
REFERENCE DESIGNATION	DESCRIPTION	PART NO.

REVISIONS	CHK	CHG NO.	REV.
		00001	B
		00003	C

DRN.	DATE
M. Peller	4-17-68
CHK'D	DATE
ENG.	DATE
P. Rickett	4-17-68
PROD.	DATE

TRANSISTOR & DIODE CONVERSION CHART			
DEC	EIA	DEC	EIA
DEC4258	2N4256		
DEC4274	NONE		
D662	1N645		
D664	1N3606		

digital		TITLE	
EQUIPMENT CORPORATION		CRYSTAL CLOCK M405	
SIZE	CODE	NUMBER	REV.
B	CS	M405-0-1	C
PRINTED CIRCUIT REV.			
			3

DEC FORM NO. DRB 102

DIST. 2/2/68 PINK