

DRN.	DATE	BY	DATE	TITLE:
CHK'D	DATE	BY	DATE	BOARD LOCATION:
DSK1P062.12P.158.3417	11-JUN-79	11-JUN-79	11-JUN-79	11-JUN-79
FIRST USED ON OPTION/MODEL:	11-744	B-DD-KD11-2-2	11-744	B-DD-KD11-2-2
SIZE	CODE	FD	REV.	
D	D	D	B	B

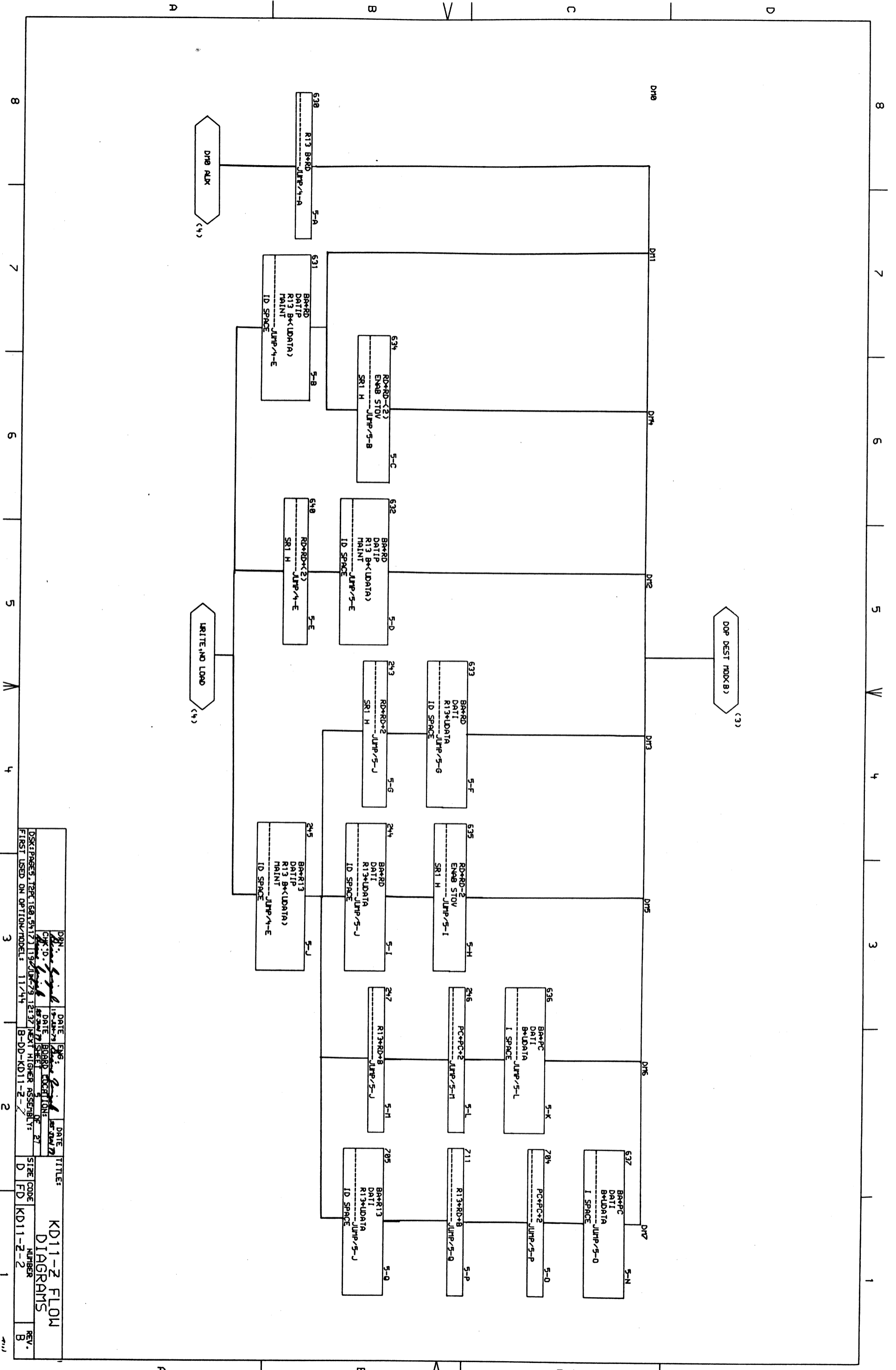





DPN.	DATE	ENG.	DATE	TITLE:
15-11-79	15-11-79	11/79	11/79	KD11-2 FLOW
CHK'D.	DATE	BOB'D	DATE	DIAGRAMS
11/79	11/79	11/79	11/79	NUMBER
DSKIPAGES: 12PC 158, 5112, 119, 79, 12137	11/79	8-DD-KD11-2-2		REV. B
FIRST USED ON OPTION/ROBEL: 11/79				

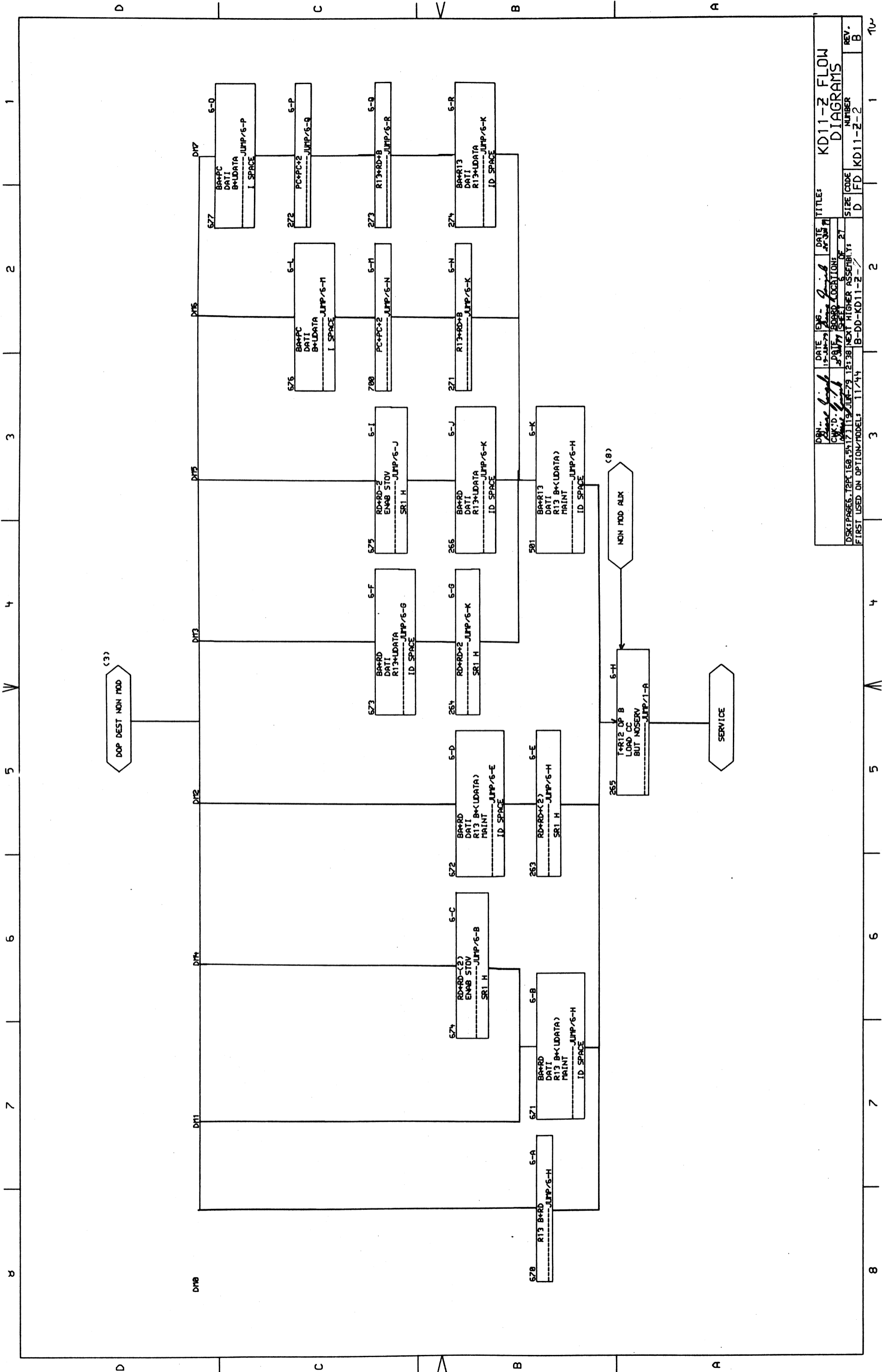

DATE	19-11-79	DATE	19-11-79	TITLE	11-11-79
CHK'D.	PAUL	CHK'D.	PAUL	BOARD LOCATION	11-11-79
DATE	11/44	DATE	11/44	SIZE	D
REV.	B	REV.	B	FD	11-11-79
FIRST USED ON OPTION/MODEL: 11/44		NEXT HIGHER ASSEMBLY: B-DD-KD11-2		NUMBER	
				11-11-79	

11-11-79  
 11-11-79  
 11-11-79  
 11-11-79  
 11-11-79

11-11-79  
 11-11-79  
 11-11-79  
 11-11-79  
 11-11-79

11-11-79  
 11-11-79  
 11-11-79  
 11-11-79  
 11-11-79

11-11-79  
 11-11-79  
 11-11-79  
 11-11-79  
 11-11-79

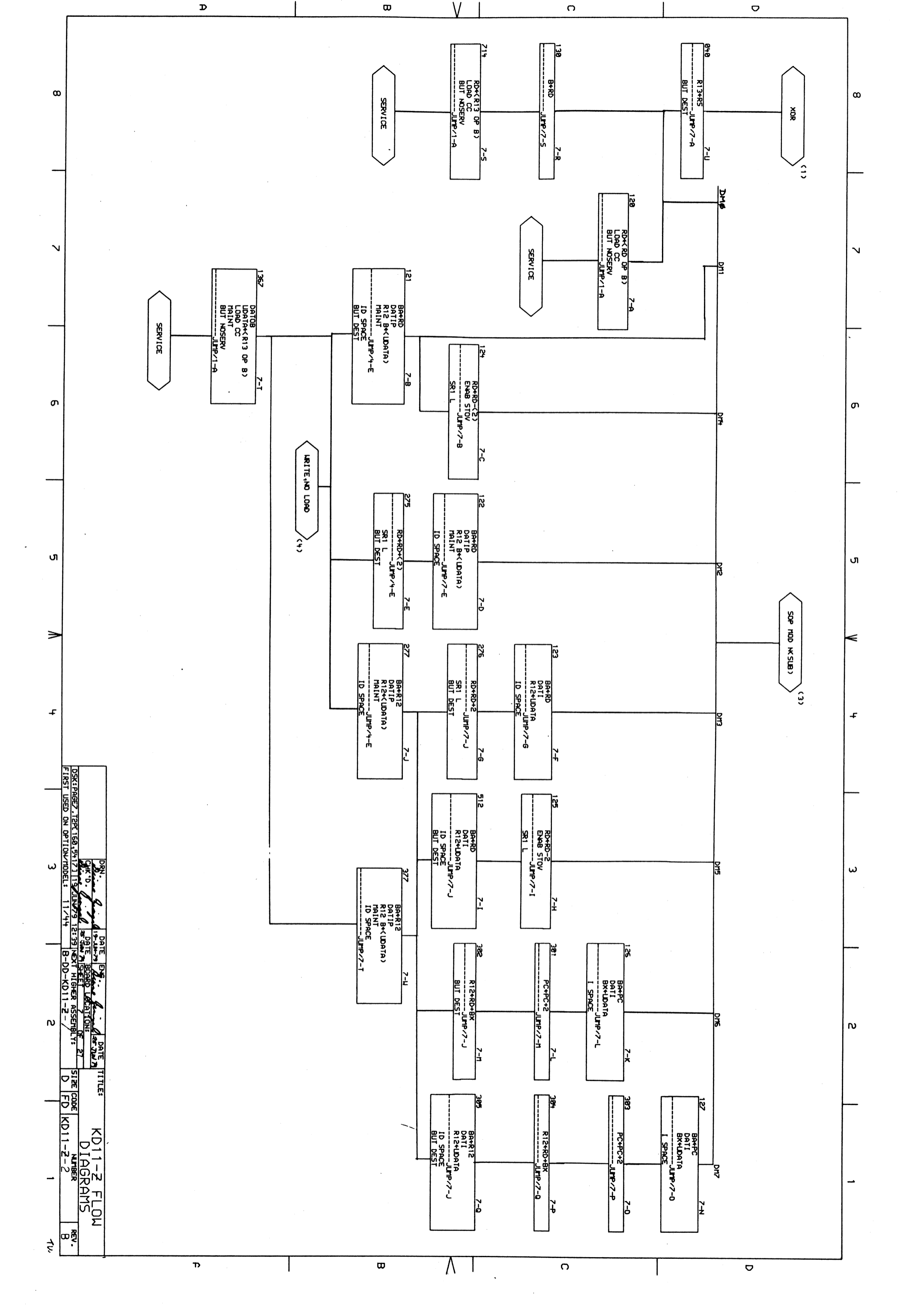

DSN: [Signature] DATE: 15 JUN 79  
 CHK'D: [Signature] DATE: 27 JUN 79  
 DESIGNED BY: [Signature] DATE: 11 JUN 79  
 FIRST USED ON OPTION/MODEL: 11/44 B-DD-KD11-2-2

TITLE: **KD11-Z FLOW DIAGRAMS**  
 SIZE CODE: D FD  
 NUMBER: KD11-2-2  
 REV: B



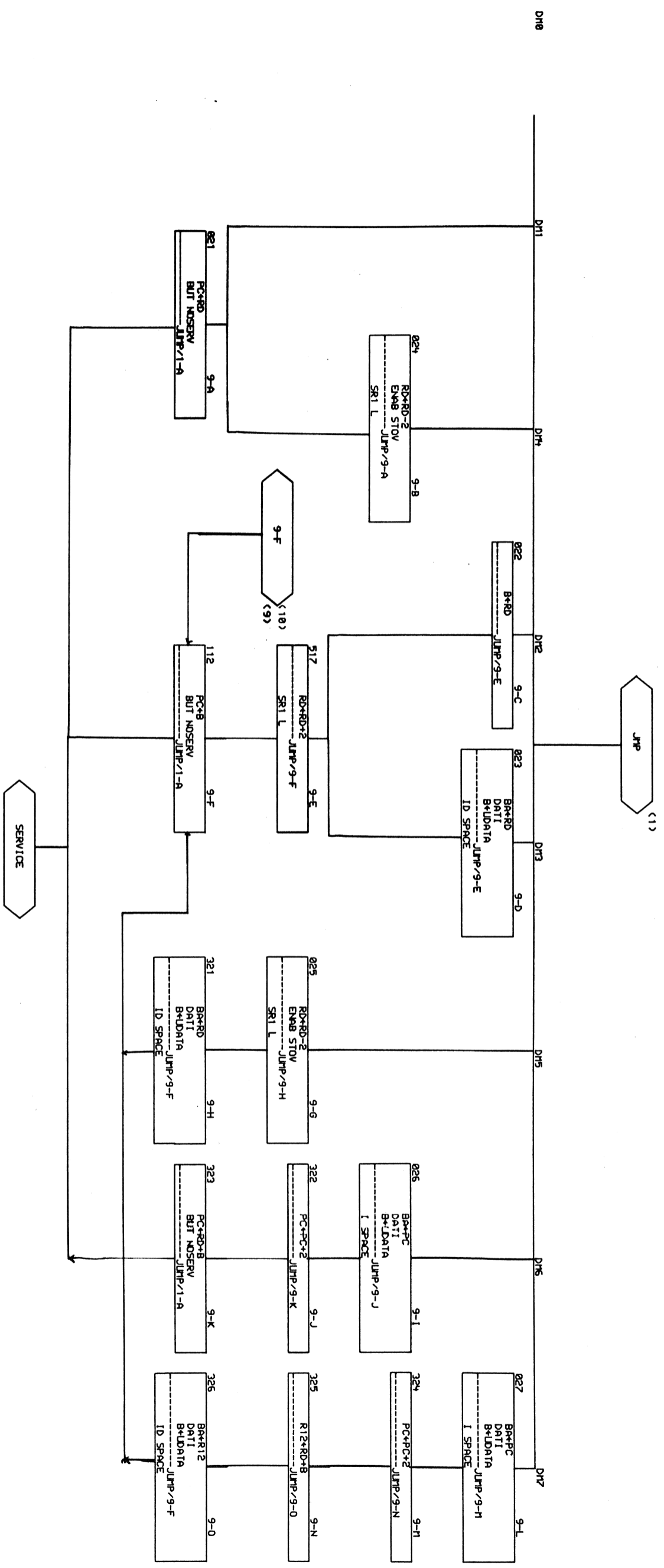

DRN.	11-2-73	DATE	11-2-73	ENG.	11-2-73	DATE	11-2-73	TITLE:	KD11-2 FLOW
CHK'D.	11-2-73	DATE	11-2-73	BOARD	11-2-73	DATE	11-2-73	SIZE CODE	D
DSK:PAGE9	12PK150	EXT	115	EXT	1239	EXT	115	NUMBER	KD11-2-2
FIRST USED ON OPTION/MODEL:	11/44 B-DD-KD11-2								

DIAGRAMS

REV. B

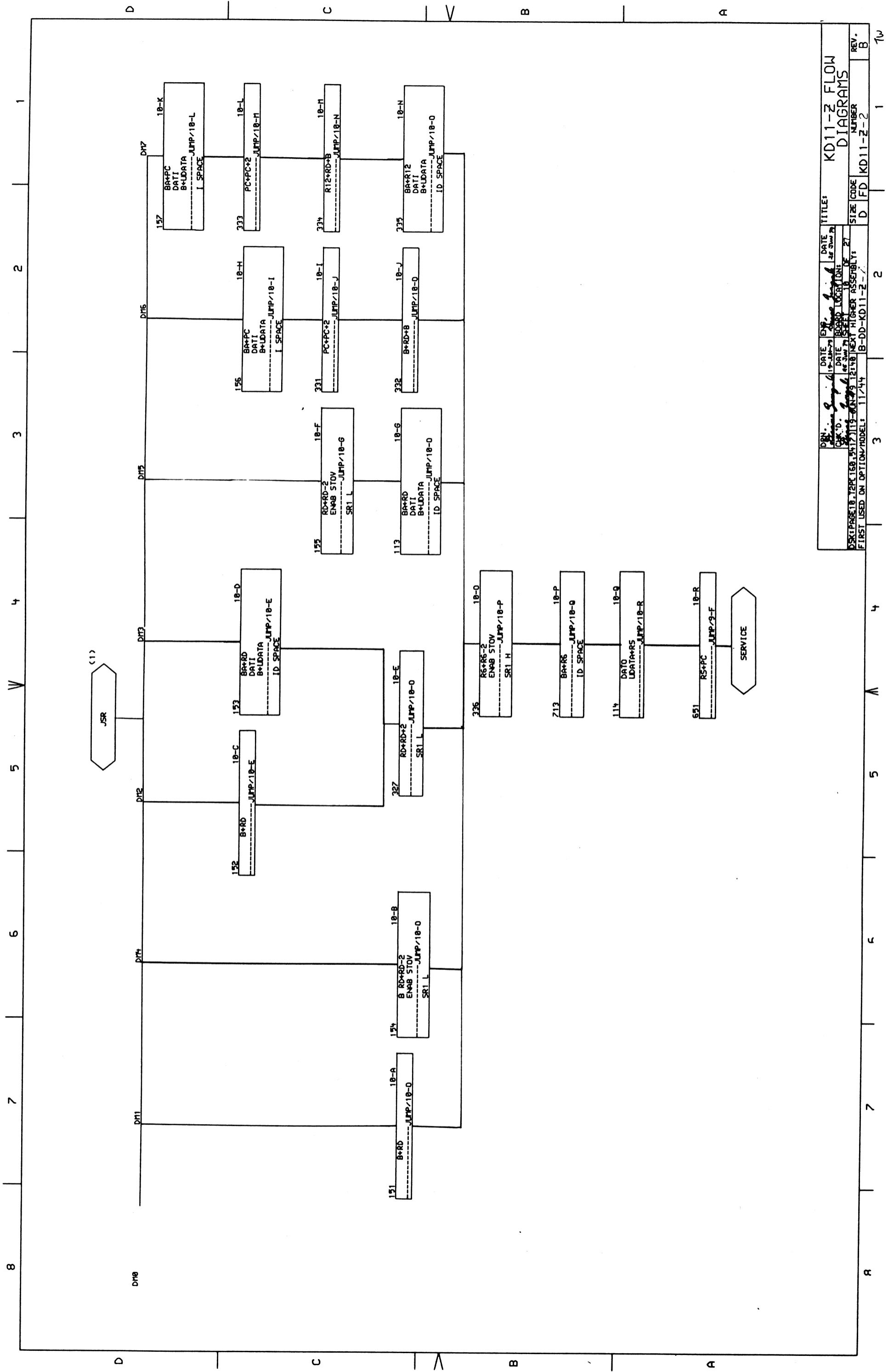

DATE	11/12/79	DATE	11/12/79	DATE	11/12/79	DATE	11/12/79
BY	...	BY	...	BY	...	BY	...
CHK'D	...	CHK'D	...	CHK'D	...	CHK'D	...
SIZE	D	SIZE	D	SIZE	D	SIZE	D
FD	FD	FD	FD	FD	FD	FD	FD
NUMBER	1	NUMBER	1	NUMBER	1	NUMBER	1
REV.	B	REV.	B	REV.	B	REV.	B

TITLE: KD11-Z FLOW DIAGRAMS  
 BOARD LOCATION: 10 OF 27  
 NEXT HIGHER ASSEMBLY: B-DD-KD11-Z-1  
 FIRST USED ON OPTION/MODEL: 11/44 B-DD-KD11-Z-1





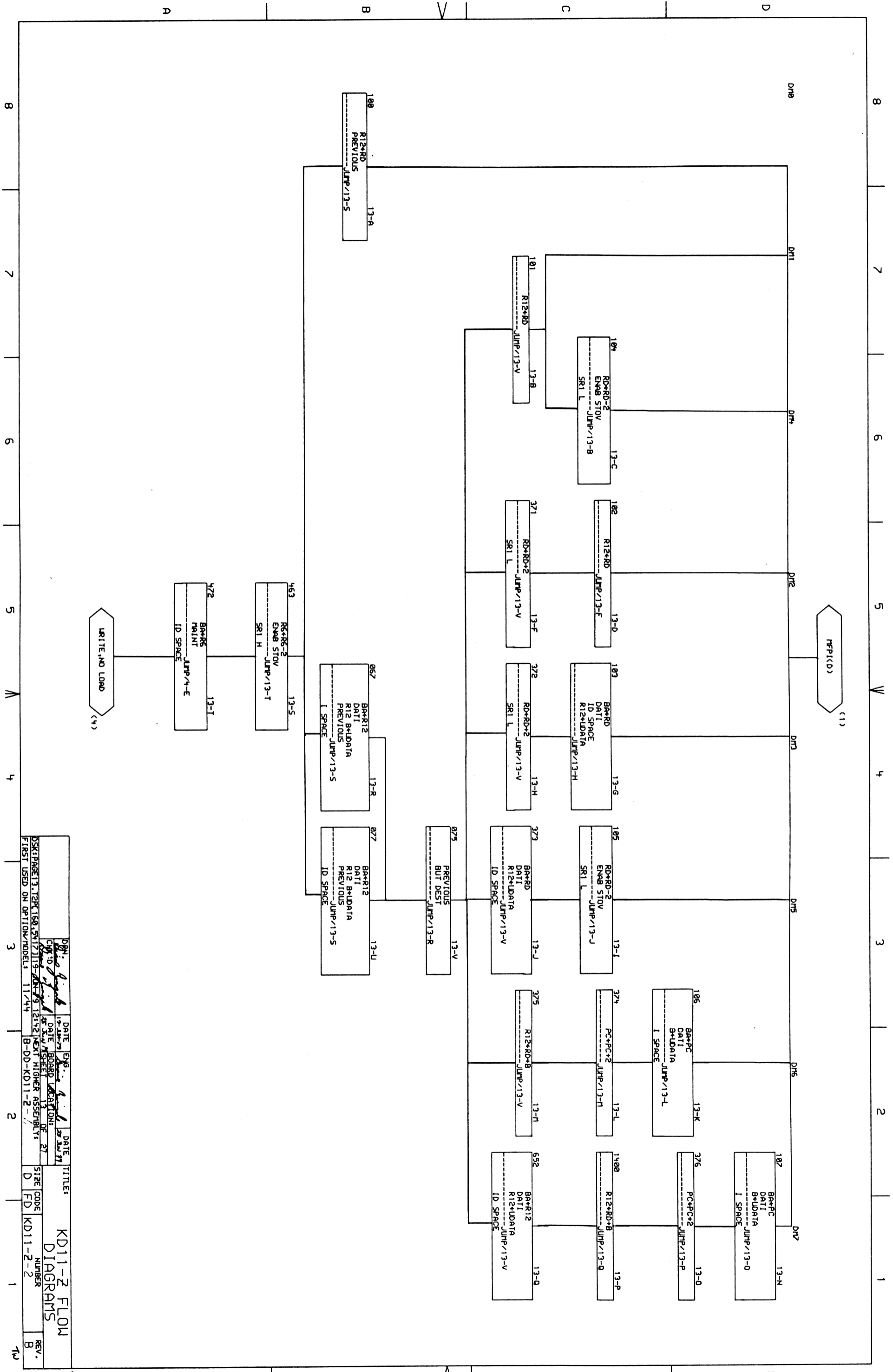

DATE		ENG.	DATE	TITLE:
11/27	11/27	11/27	11/27	KD11-2 FLOW
11/27	11/27	11/27	11/27	DIAGRAMS
11/27	11/27	11/27	11/27	NUMBER
11/27	11/27	11/27	11/27	REV. B
DSK:PAGE13.TPR:158.512.113-05-29 12:42 FIRST USED ON OPTION/MODEL: 11/44 B-DD-KD11-2-2				SIZE CODE FD KD11-2-2

KD11-2 FLOW  
DIAGRAMS  
NUMBER

REV. B

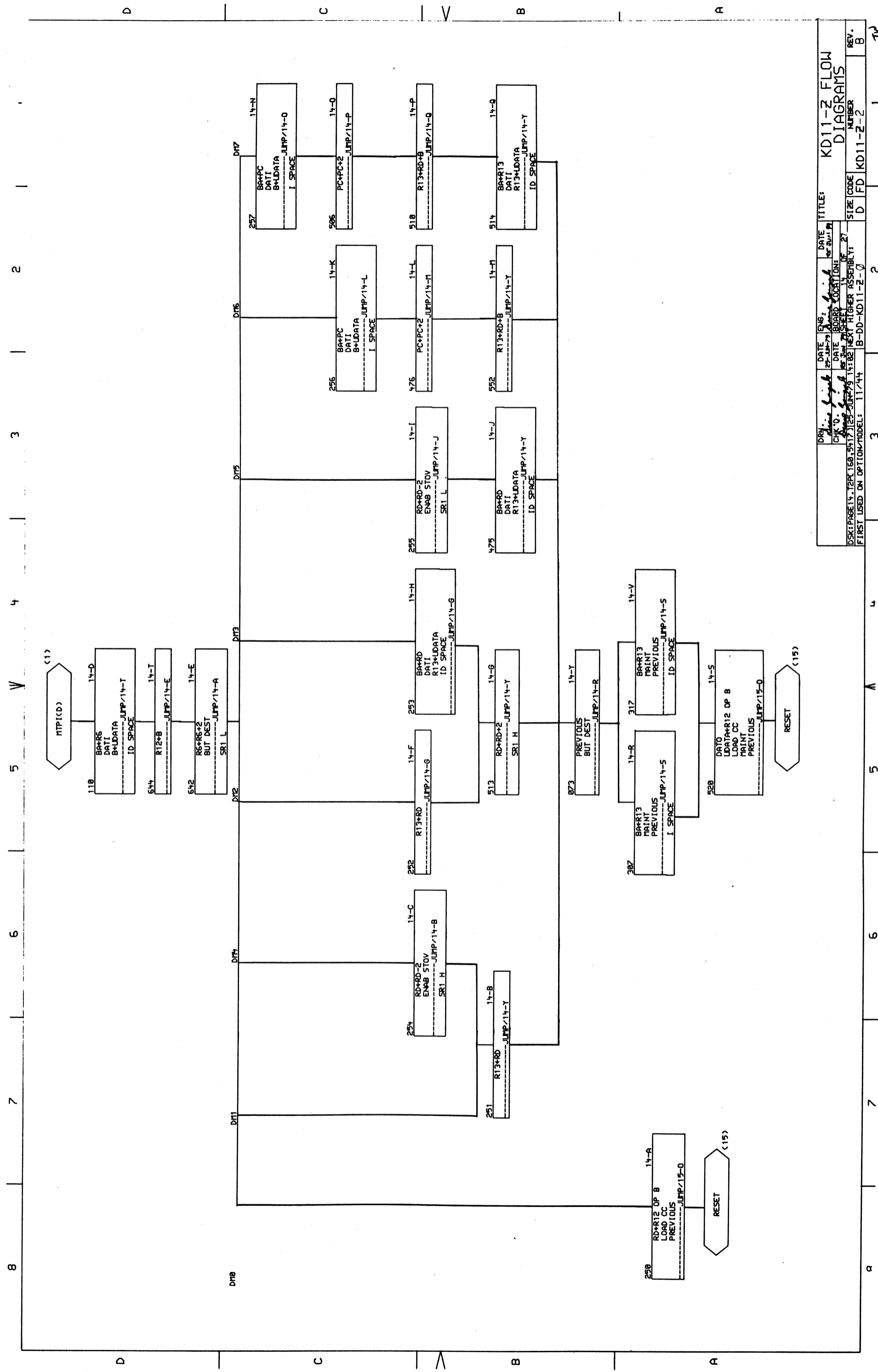

REV. B	NUMBER	SIZE	DATE	TITLE
27	27	D	11/14	KD11-Z FLOW DIAGRAMS
REV. B	NUMBER	SIZE	DATE	TITLE
27	27	D	11/14	KD11-Z FLOW DIAGRAMS
REV. B	NUMBER	SIZE	DATE	TITLE
27	27	D	11/14	KD11-Z FLOW DIAGRAMS

REV. B	NUMBER	SIZE	DATE	TITLE
27	27	D	11/14	KD11-Z FLOW DIAGRAMS
REV. B	NUMBER	SIZE	DATE	TITLE
27	27	D	11/14	KD11-Z FLOW DIAGRAMS
REV. B	NUMBER	SIZE	DATE	TITLE
27	27	D	11/14	KD11-Z FLOW DIAGRAMS

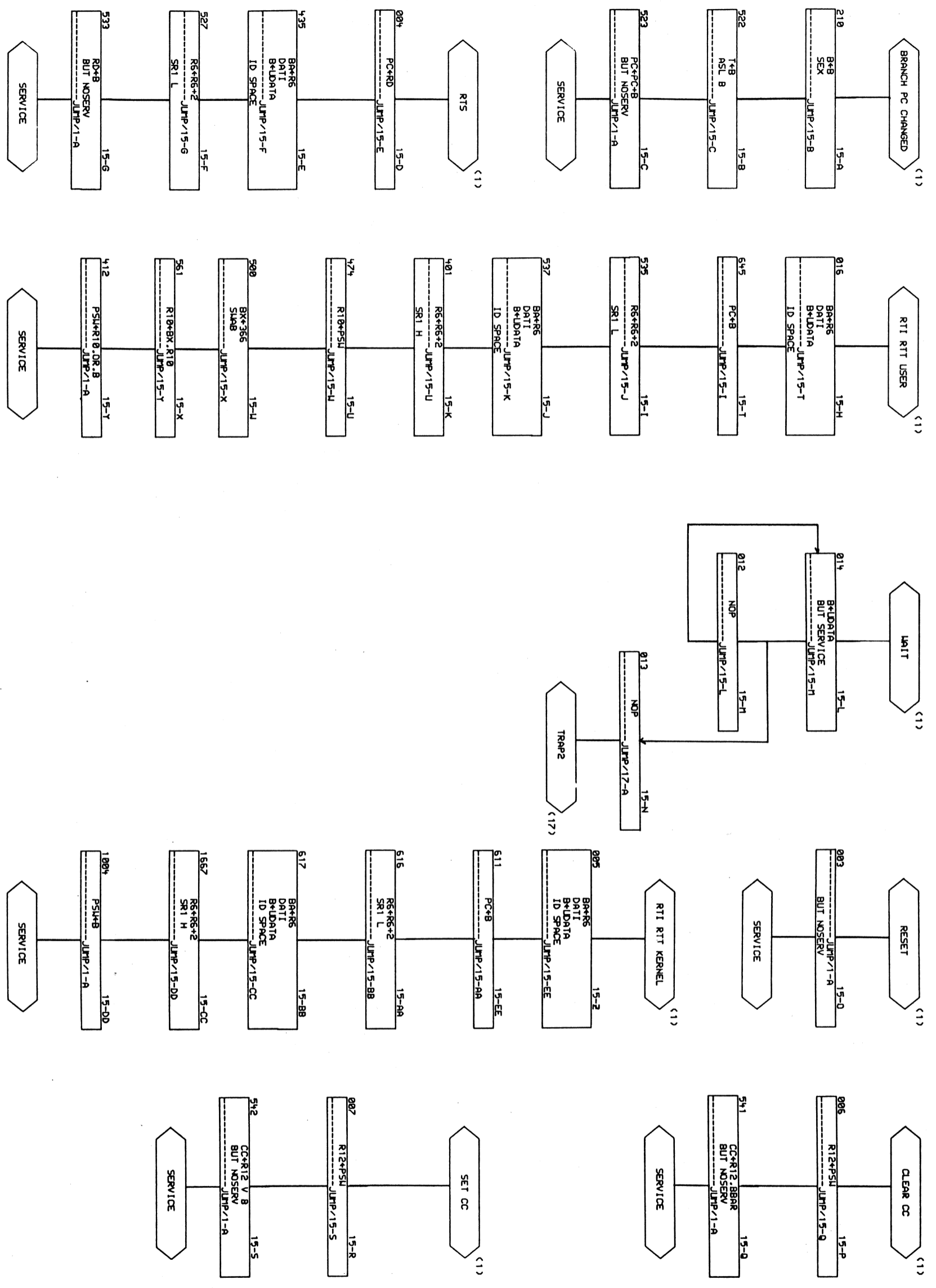

DATE	ENG.	DATE	TITLE:
12-11-73	...	12-11-73	KD11-2 FLOW
DATE	BOARD LOCATION	DATE	NUMBER
12-11-73	...	12-11-73	DIAGRAMS
SHEET	OF	REV.	
15	27	B	
FIRST USED ON OPTION/MODEL: 11/74			
B-DD-KD11-2-C			
SIZE	CODE	FD	REV.
D	FD	KD11-2-2	B

2 7 5 5 4 3 3 1

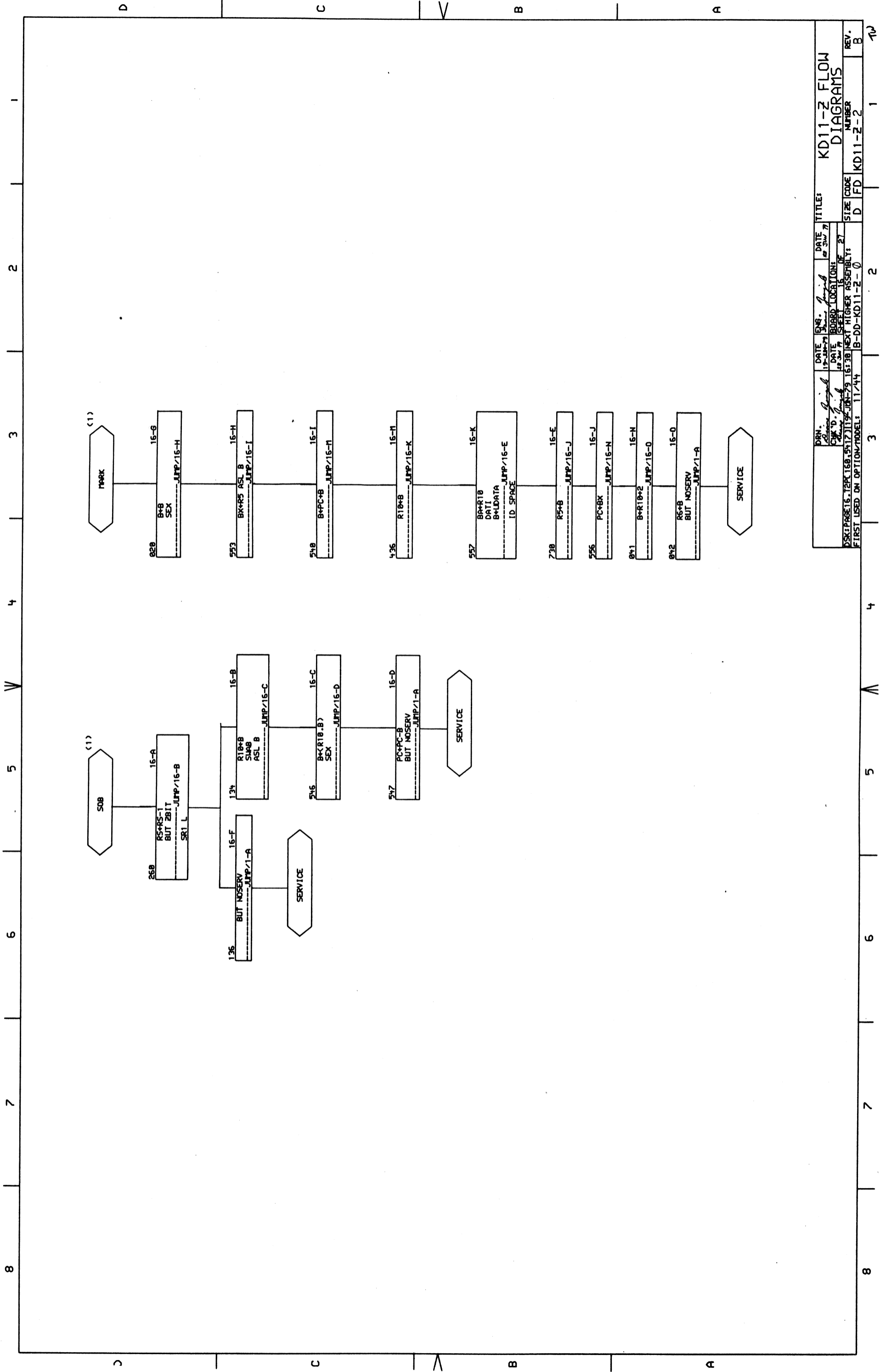

DRN.	ENG.	DATE	DATE	TITLE:
CHK'D	CHK'D	15-JUN-79	15-JUN-79	KD11-Z FLOW DIAGRAMS
BY	BY	15	15	DIAGRAMS
NO.	NO.	15	15	DIAGRAMS
REV.	REV.	15	15	DIAGRAMS
1	1	15	15	DIAGRAMS
2	2	15	15	DIAGRAMS
3	3	15	15	DIAGRAMS
4	4	15	15	DIAGRAMS
5	5	15	15	DIAGRAMS
6	6	15	15	DIAGRAMS
7	7	15	15	DIAGRAMS
8	8	15	15	DIAGRAMS
9	9	15	15	DIAGRAMS
10	10	15	15	DIAGRAMS
11	11	15	15	DIAGRAMS
12	12	15	15	DIAGRAMS
13	13	15	15	DIAGRAMS
14	14	15	15	DIAGRAMS
15	15	15	15	DIAGRAMS
16	16	15	15	DIAGRAMS
17	17	15	15	DIAGRAMS
18	18	15	15	DIAGRAMS
19	19	15	15	DIAGRAMS
20	20	15	15	DIAGRAMS
21	21	15	15	DIAGRAMS
22	22	15	15	DIAGRAMS
23	23	15	15	DIAGRAMS
24	24	15	15	DIAGRAMS
25	25	15	15	DIAGRAMS
26	26	15	15	DIAGRAMS
27	27	15	15	DIAGRAMS
28	28	15	15	DIAGRAMS
29	29	15	15	DIAGRAMS
30	30	15	15	DIAGRAMS
31	31	15	15	DIAGRAMS
32	32	15	15	DIAGRAMS
33	33	15	15	DIAGRAMS
34	34	15	15	DIAGRAMS
35	35	15	15	DIAGRAMS
36	36	15	15	DIAGRAMS
37	37	15	15	DIAGRAMS
38	38	15	15	DIAGRAMS
39	39	15	15	DIAGRAMS
40	40	15	15	DIAGRAMS
41	41	15	15	DIAGRAMS
42	42	15	15	DIAGRAMS
43	43	15	15	DIAGRAMS
44	44	15	15	DIAGRAMS
45	45	15	15	DIAGRAMS
46	46	15	15	DIAGRAMS
47	47	15	15	DIAGRAMS
48	48	15	15	DIAGRAMS
49	49	15	15	DIAGRAMS
50	50	15	15	DIAGRAMS
51	51	15	15	DIAGRAMS
52	52	15	15	DIAGRAMS
53	53	15	15	DIAGRAMS
54	54	15	15	DIAGRAMS
55	55	15	15	DIAGRAMS
56	56	15	15	DIAGRAMS
57	57	15	15	DIAGRAMS
58	58	15	15	DIAGRAMS
59	59	15	15	DIAGRAMS
60	60	15	15	DIAGRAMS
61	61	15	15	DIAGRAMS
62	62	15	15	DIAGRAMS
63	63	15	15	DIAGRAMS
64	64	15	15	DIAGRAMS
65	65	15	15	DIAGRAMS
66	66	15	15	DIAGRAMS
67	67	15	15	DIAGRAMS
68	68	15	15	DIAGRAMS
69	69	15	15	DIAGRAMS
70	70	15	15	DIAGRAMS
71	71	15	15	DIAGRAMS
72	72	15	15	DIAGRAMS
73	73	15	15	DIAGRAMS
74	74	15	15	DIAGRAMS
75	75	15	15	DIAGRAMS
76	76	15	15	DIAGRAMS
77	77	15	15	DIAGRAMS
78	78	15	15	DIAGRAMS
79	79	15	15	DIAGRAMS
80	80	15	15	DIAGRAMS
81	81	15	15	DIAGRAMS
82	82	15	15	DIAGRAMS
83	83	15	15	DIAGRAMS
84	84	15	15	DIAGRAMS
85	85	15	15	DIAGRAMS
86	86	15	15	DIAGRAMS
87	87	15	15	DIAGRAMS
88	88	15	15	DIAGRAMS
89	89	15	15	DIAGRAMS
90	90	15	15	DIAGRAMS
91	91	15	15	DIAGRAMS
92	92	15	15	DIAGRAMS
93	93	15	15	DIAGRAMS
94	94	15	15	DIAGRAMS
95	95	15	15	DIAGRAMS
96	96	15	15	DIAGRAMS
97	97	15	15	DIAGRAMS
98	98	15	15	DIAGRAMS
99	99	15	15	DIAGRAMS
100	100	15	15	DIAGRAMS

DSK:PAGE16.TEPC16B.517 J1197 JON-79 16:38 NEXT HIGHER ASSEMBLY:  
 FIRST USED ON OPTION/MODEL: 11/44 B-DD-KD11-Z-0  
 B-DD-KD11-Z-2  
 REV. B

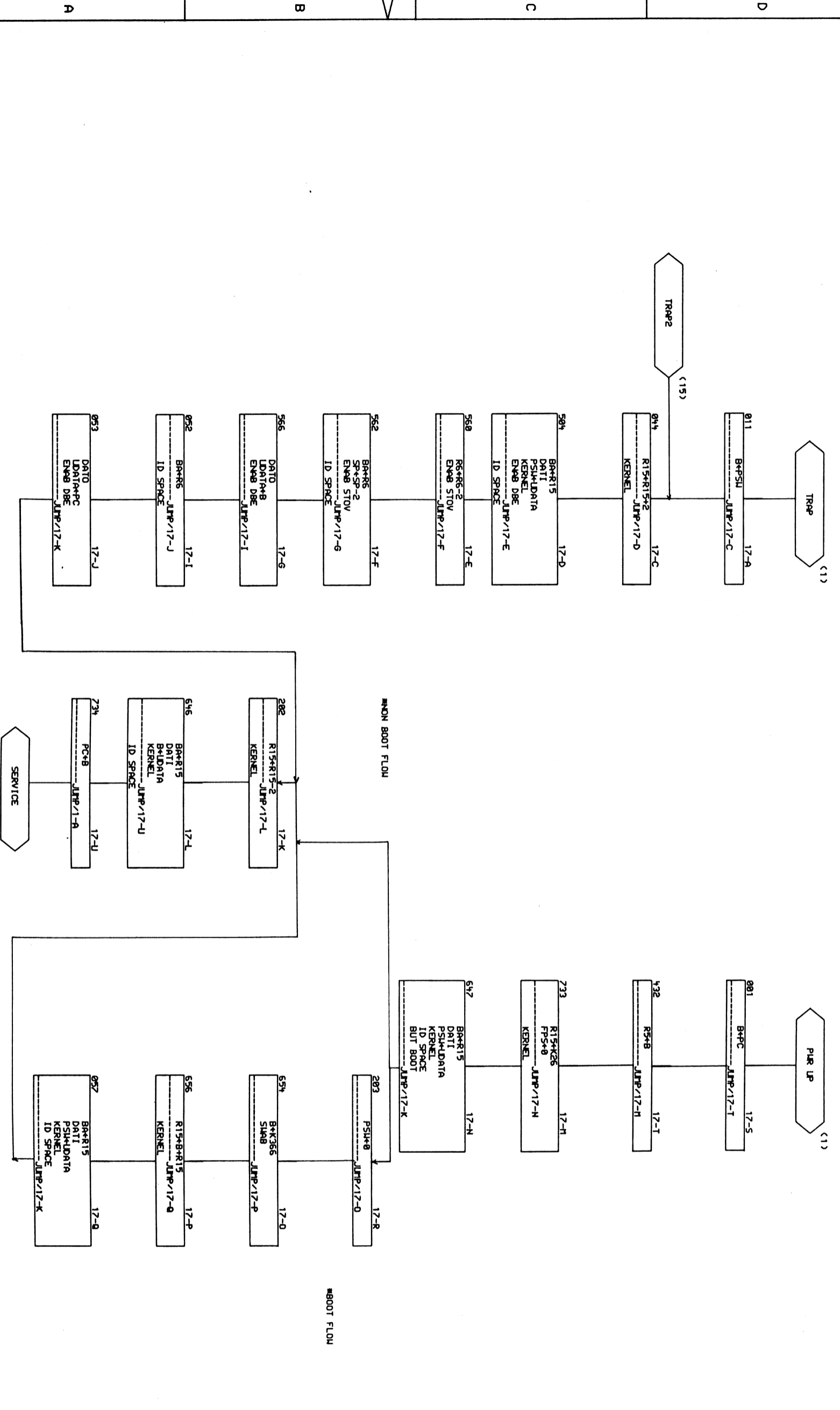

DGN: <i>George</i>		DATE: <i>11/27/74</i>		TITLE: <b>KD11-2 FLOW</b>	
CHK'D: <i>George</i>		DATE: <i>11/27/74</i>		TITLE: <b>DIAGRAMS</b>	
DATE: <i>11/27/74</i>		DATE: <i>11/27/74</i>		REV: <b>B</b>	
SHEET: <i>17</i>		SHEET: <i>17</i>		REV. NUMBER: <b>2</b>	
OSK: PAGE 17, TRAP, 168, 517, 1128		OSK: NEXT HIGHER ASSEMBLY: <b>B-DD-KD11-2-0</b>		REV. NUMBER: <b>2</b>	
FIRST USED ON OPTION-MODEL: <b>11/74</b>		B-DD-KD11-2-0		REV. NUMBER: <b>2</b>	

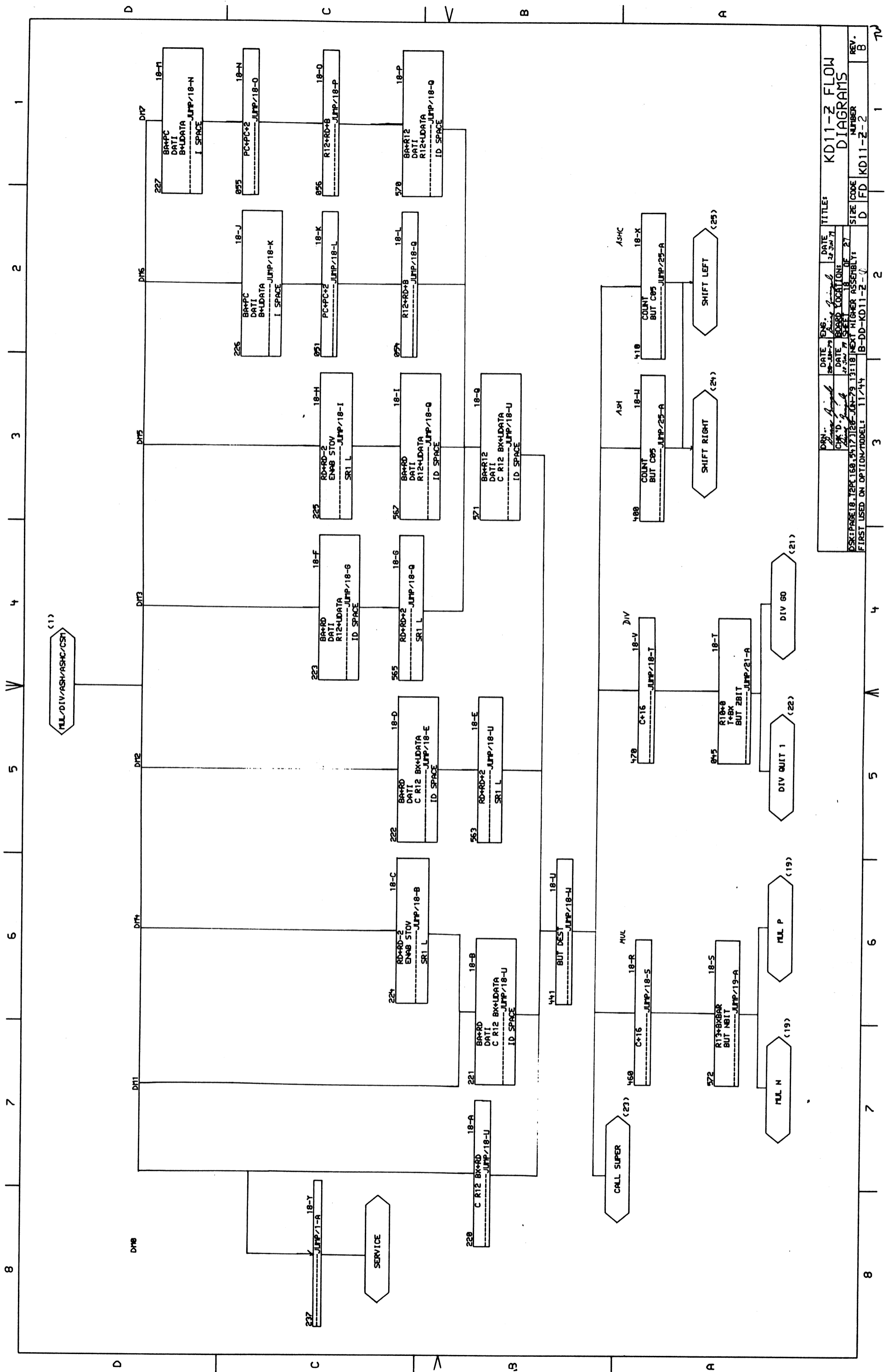

TITLE: KD11-Z FLOW DIAGRAMS			
DATE	ENG.	DATE	REV.
28-JUN-79	John J. ...	27-JUN-79	B
27-JUN-79	...	18-JUN-79	A
18-JUN-79	...	11-JUN-79	...

DSK: PAGE 18, 18P, 18S, 18T, 18U, 18V, 18W, 18X, 18Y, 18Z, 18AA, 18AB, 18AC, 18AD, 18AE, 18AF, 18AG, 18AH, 18AI, 18AJ, 18AK, 18AL, 18AM, 18AN, 18AO, 18AP, 18AQ, 18AR, 18AS, 18AT, 18AU, 18AV, 18AW, 18AX, 18AY, 18AZ, 18BA, 18BB, 18BC, 18BD, 18BE, 18BF, 18BG, 18BH, 18BI, 18BJ, 18BK, 18BL, 18BM, 18BN, 18BO, 18BP, 18BQ, 18BR, 18BS, 18BT, 18BU, 18BV, 18BW, 18BX, 18BY, 18BZ, 18CA, 18CB, 18CC, 18CD, 18CE, 18CF, 18CG, 18CH, 18CI, 18CJ, 18CK, 18CL, 18CM, 18CN, 18CO, 18CP, 18CQ, 18CR, 18CS, 18CT, 18CU, 18CV, 18CW, 18CX, 18CY, 18CZ, 18DA, 18DB, 18DC, 18DD, 18DE, 18DF, 18DG, 18DH, 18DI, 18DJ, 18DK, 18DL, 18DM, 18DN, 18DO, 18DP, 18DQ, 18DR, 18DS, 18DT, 18DU, 18DV, 18DW, 18DX, 18DY, 18DZ, 18EA, 18EB, 18EC, 18ED, 18EE, 18EF, 18EG, 18EH, 18EI, 18EJ, 18EK, 18EL, 18EM, 18EN, 18EO, 18EP, 18EQ, 18ER, 18ES, 18ET, 18EU, 18EV, 18EW, 18EX, 18EY, 18EZ, 18FA, 18FB, 18FC, 18FD, 18FE, 18FF, 18FG, 18FH, 18FI, 18FJ, 18FK, 18FL, 18FM, 18FN, 18FO, 18FP, 18FQ, 18FR, 18FS, 18FT, 18FU, 18FV, 18FW, 18FX, 18FY, 18FZ, 18GA, 18GB, 18GC, 18GD, 18GE, 18GF, 18GG, 18GH, 18GI, 18GJ, 18GK, 18GL, 18GM, 18GN, 18GO, 18GP, 18GQ, 18GR, 18GS, 18GT, 18GU, 18GV, 18GW, 18GX, 18GY, 18GZ, 18HA, 18HB, 18HC, 18HD, 18HE, 18HF, 18HG, 18HH, 18HI, 18HJ, 18HK, 18HL, 18HM, 18HN, 18HO, 18HP, 18HQ, 18HR, 18HS, 18HT, 18HU, 18HV, 18HW, 18HX, 18HY, 18HZ, 18IA, 18IB, 18IC, 18ID, 18IE, 18IF, 18IG, 18IH, 18II, 18IJ, 18IK, 18IL, 18IM, 18IN, 18IO, 18IP, 18IQ, 18IR, 18IS, 18IT, 18IU, 18IV, 18IW, 18IX, 18IY, 18IZ, 18JA, 18JB, 18JC, 18JD, 18JE, 18JF, 18JG, 18JH, 18JI, 18JJ, 18JK, 18JL, 18JM, 18JN, 18JO, 18JP, 18JQ, 18JR, 18JS, 18JT, 18JU, 18JV, 18JW, 18JX, 18JY, 18JZ, 18KA, 18KB, 18KC, 18KD, 18KE, 18KF, 18KG, 18KH, 18KI, 18KJ, 18KK, 18KL, 18KM, 18KN, 18KO, 18KP, 18KQ, 18KR, 18KS, 18KT, 18KU, 18KV, 18KW, 18KX, 18KY, 18KZ, 18LA, 18LB, 18LC, 18LD, 18LE, 18LF, 18LG, 18LH, 18LI, 18LJ, 18LK, 18LL, 18LM, 18LN, 18LO, 18LP, 18LQ, 18LR, 18LS, 18LT, 18LU, 18LV, 18LW, 18LX, 18LY, 18LZ, 18MA, 18MB, 18MC, 18MD, 18ME, 18MF, 18MG, 18MH, 18MI, 18MJ, 18MK, 18ML, 18MN, 18MO, 18MP, 18MQ, 18MR, 18MS, 18MT, 18MU, 18MV, 18MW, 18MX, 18MY, 18MZ, 18NA, 18NB, 18NC, 18ND, 18NE, 18NF, 18NG, 18NH, 18NI, 18NJ, 18NK, 18NL, 18NM, 18NO, 18NP, 18NQ, 18NR, 18NS, 18NT, 18NU, 18NV, 18NW, 18NX, 18NY, 18NZ, 18OA, 18OB, 18OC, 18OD, 18OE, 18OF, 18OG, 18OH, 18OI, 18OJ, 18OK, 18OL, 18OM, 18ON, 18OO, 18OP, 18OQ, 18OR, 18OS, 18OT, 18OU, 18OV, 18OW, 18OX, 18OY, 18OZ, 18PA, 18PB, 18PC, 18PD, 18PE, 18PF, 18PG, 18PH, 18PI, 18PJ, 18PK, 18PL, 18PM, 18PN, 18PO, 18PP, 18PQ, 18PR, 18PS, 18PT, 18PU, 18PV, 18PW, 18PX, 18PY, 18PZ, 18QA, 18QB, 18QC, 18QD, 18QE, 18QF, 18QG, 18QH, 18QI, 18QJ, 18QK, 18QL, 18QM, 18QN, 18QO, 18QP, 18QQ, 18QR, 18QS, 18QT, 18QU, 18QV, 18QW, 18QX, 18QY, 18QZ, 18RA, 18RB, 18RC, 18RD, 18RE, 18RF, 18RG, 18RH, 18RI, 18RJ, 18RK, 18RL, 18RM, 18RN, 18RO, 18RP, 18RQ, 18RR, 18RS, 18RT, 18RU, 18RV, 18RW, 18RX, 18RY, 18RZ, 18SA, 18SB, 18SC, 18SD, 18SE, 18SF, 18SG, 18SH, 18SI, 18SJ, 18SK, 18SL, 18SM, 18SN, 18SO, 18SP, 18SQ, 18SR, 18SS, 18ST, 18SU, 18SV, 18SW, 18SX, 18SY, 18SZ, 18TA, 18TB, 18TC, 18TD, 18TE, 18TF, 18TG, 18TH, 18TI, 18TJ, 18TK, 18TL, 18TM, 18TN, 18TO, 18TP, 18TQ, 18TR, 18TS, 18TT, 18TU, 18TV, 18TW, 18TX, 18TY, 18TZ, 18UA, 18UB, 18UC, 18UD, 18UE, 18UF, 18UG, 18UH, 18UI, 18UJ, 18UK, 18UL, 18UM, 18UN, 18UO, 18UP, 18UQ, 18UR, 18US, 18UT, 18UU, 18UV, 18UW, 18UX, 18UY, 18UZ, 18VA, 18VB, 18VC, 18VD, 18VE, 18VF, 18VG, 18VH, 18VI, 18VJ, 18VK, 18VL, 18VM, 18VN, 18VO, 18VP, 18VQ, 18VR, 18VS, 18VT, 18VU, 18VV, 18VW, 18VX, 18VY, 18VZ, 18WA, 18WB, 18WC, 18WD, 18WE, 18WF, 18WG, 18WH, 18WI, 18WJ, 18WK, 18WL, 18WM, 18WN, 18WO, 18WP, 18WQ, 18WR, 18WS, 18WT, 18WU, 18WV, 18WW, 18WX, 18WY, 18WZ, 18XA, 18XB, 18XC, 18XD, 18XE, 18XF, 18XG, 18XH, 18XI, 18XJ, 18XK, 18XL, 18XM, 18XN, 18XO, 18XP, 18XQ, 18XR, 18XS, 18XT, 18XU, 18XV, 18XW, 18XX, 18XY, 18XZ, 18YA, 18YB, 18YC, 18YD, 18YE, 18YF, 18YG, 18YH, 18YI, 18YJ, 18YK, 18YL, 18YM, 18YN, 18YO, 18YP, 18YQ, 18YR, 18YS, 18YT, 18YU, 18YV, 18YW, 18YX, 18YY, 18YZ, 18ZA, 18ZB, 18ZC, 18ZD, 18ZE, 18ZF, 18ZG, 18ZH, 18ZI, 18ZJ, 18ZK, 18ZL, 18ZM, 18ZN, 18ZO, 18ZP, 18ZQ, 18ZR, 18ZS, 18ZT, 18ZU, 18ZV, 18ZW, 18ZX, 18ZY, 18ZZ.

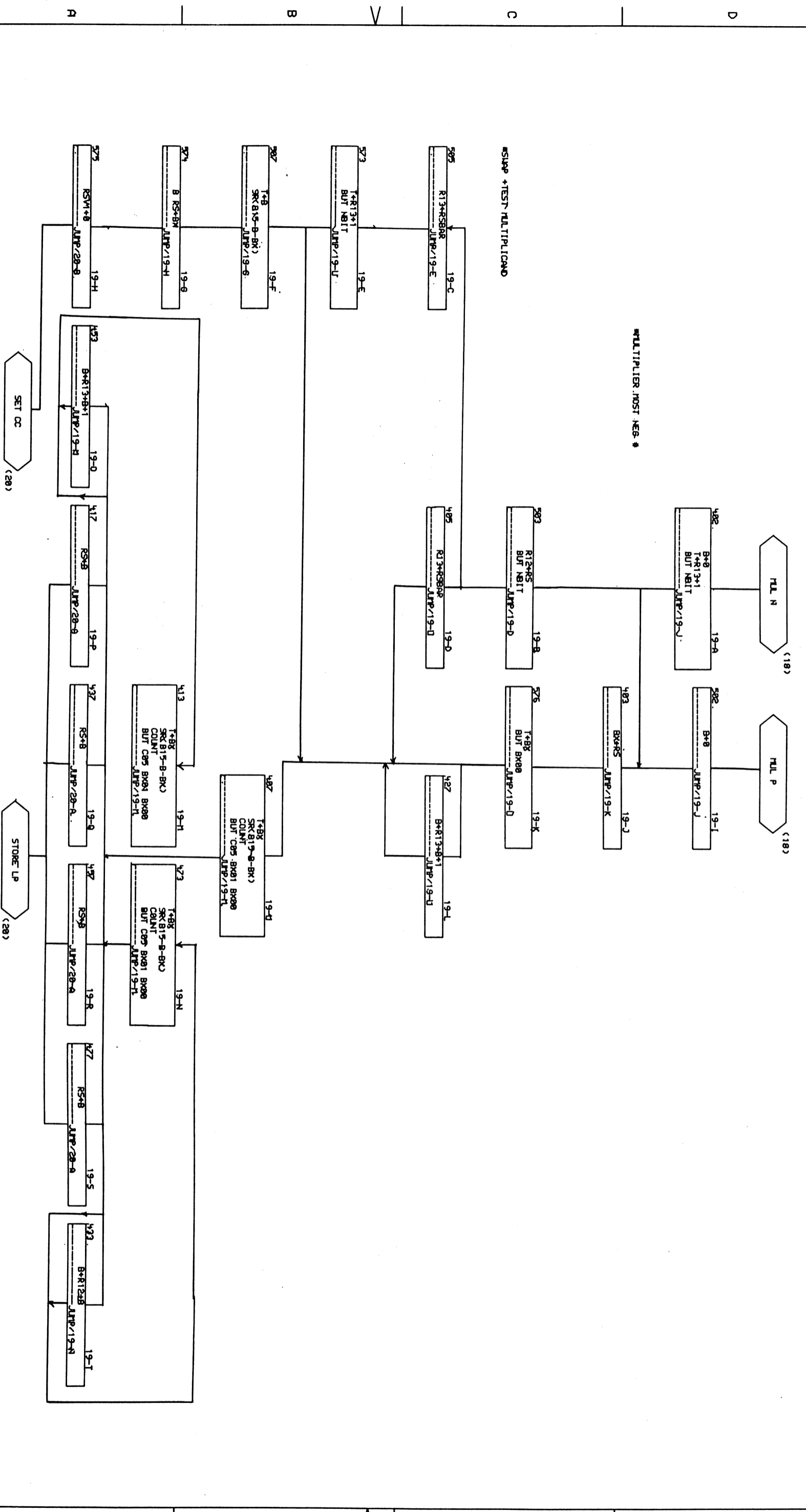

DATE	BY	DATE	TITLE
11/27/74	...	...	KD11-2 FLOW DIAGRAMS

DATE	BY	DATE	TITLE
11/27/74	...	...	KD11-2 FLOW DIAGRAMS

DATE	BY	DATE	TITLE
11/27/74	...	...	KD11-2 FLOW DIAGRAMS

  

DATE	BY	DATE	TITLE
11/27/74	...	...	KD11-2 FLOW DIAGRAMS

DATE	BY	DATE	TITLE
11/27/74	...	...	KD11-2 FLOW DIAGRAMS

DSK11-2-2-0  
 FIRST USED ON OPTION MODEL 11/74  
 B-DD-KD11-2-0

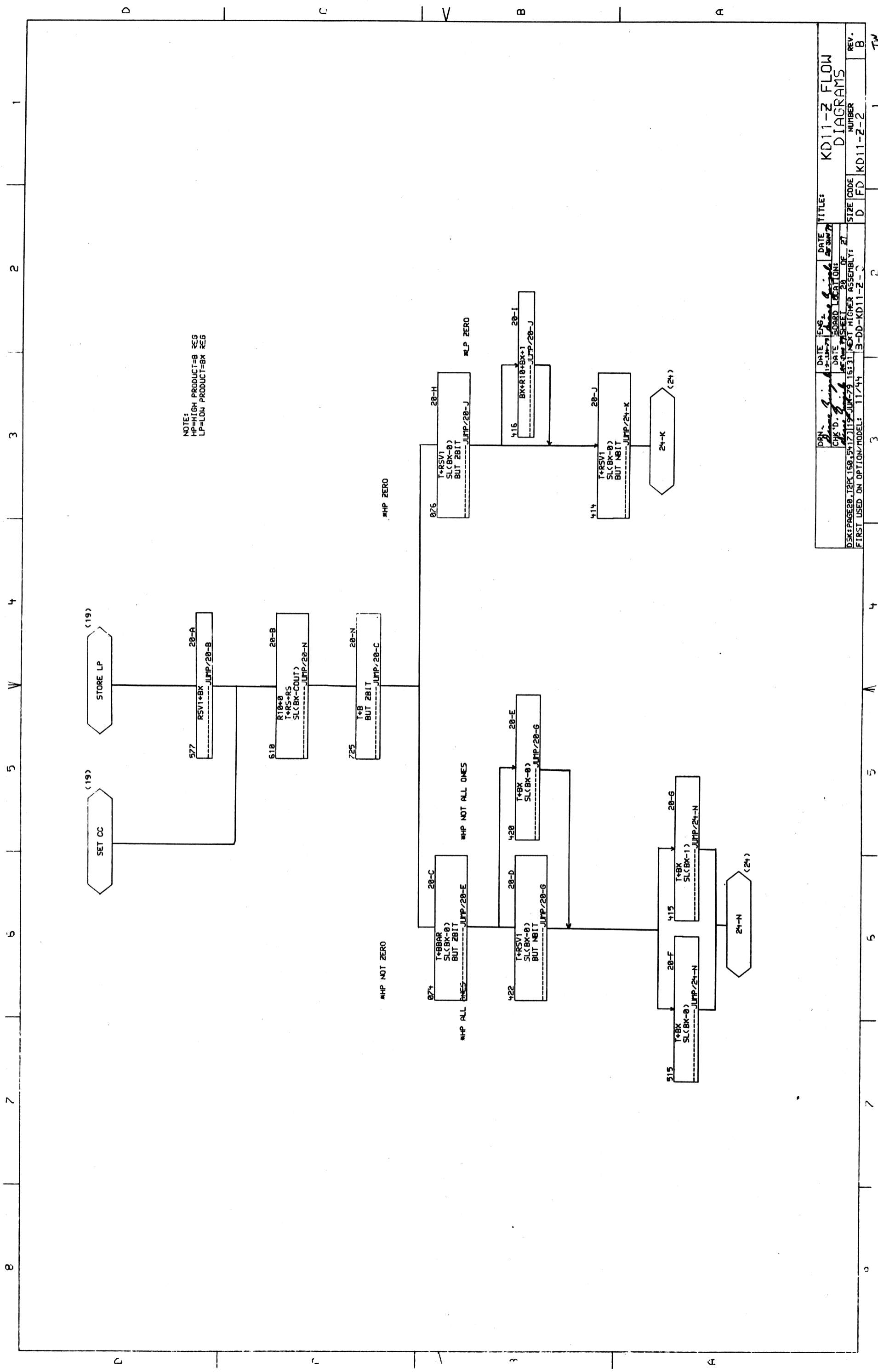

NOTE:  
 HP=HIGH PRODUCT=B RES  
 LP=LOW PRODUCT=BX RES

DRN	DATE	ENG	DATE	TITLE
CHD	11/44	3-DD	11/44	KD11-Z FLOW DIAGRAMS
DATE	11/44	DATE	11/44	REV. B
SIZE	27	SIZE	27	REV. B
CODE	D	CODE	D	REV. B
FD	KD11-Z-2	FD	KD11-Z-2	REV. B
NUMBER	1	NUMBER	1	REV. B
REV.	B	REV.	B	REV. B



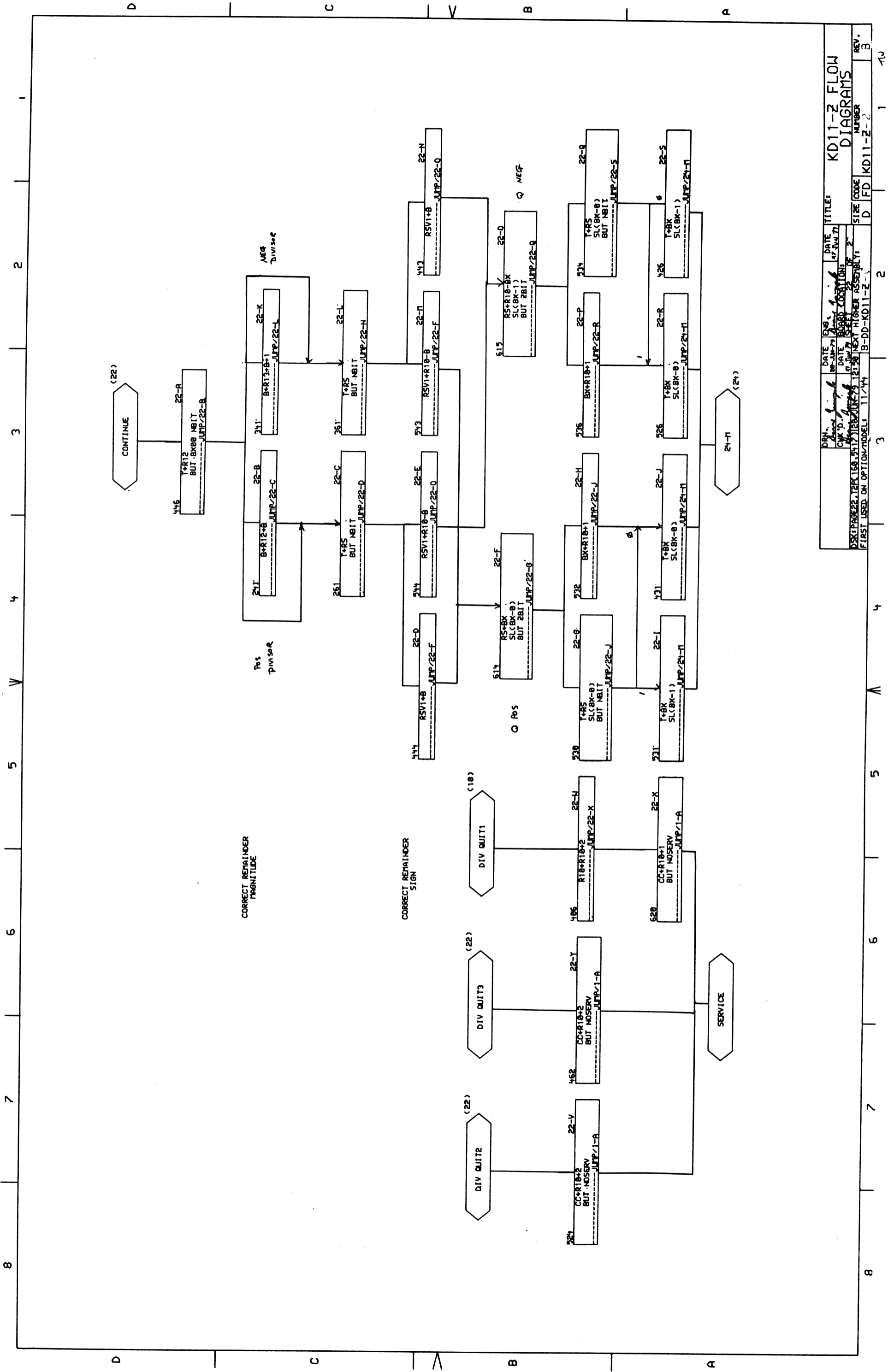

DRN.	ENG.	DATE	TITLE
CHK'D.	APP'D.	DATE	KD11-2 FLOW DIAGRAMS
DATE	BY	DATE	SIZE
11/24	B-DD	11/24	D
FIRST USED ON OPTION MODEL: 11/24			REV. 3
NEXT HIGHER ASSEMBLY: B-DD-KD11-2-1			NUMBER
NEXT LOWER ASSEMBLY:			REV. 3

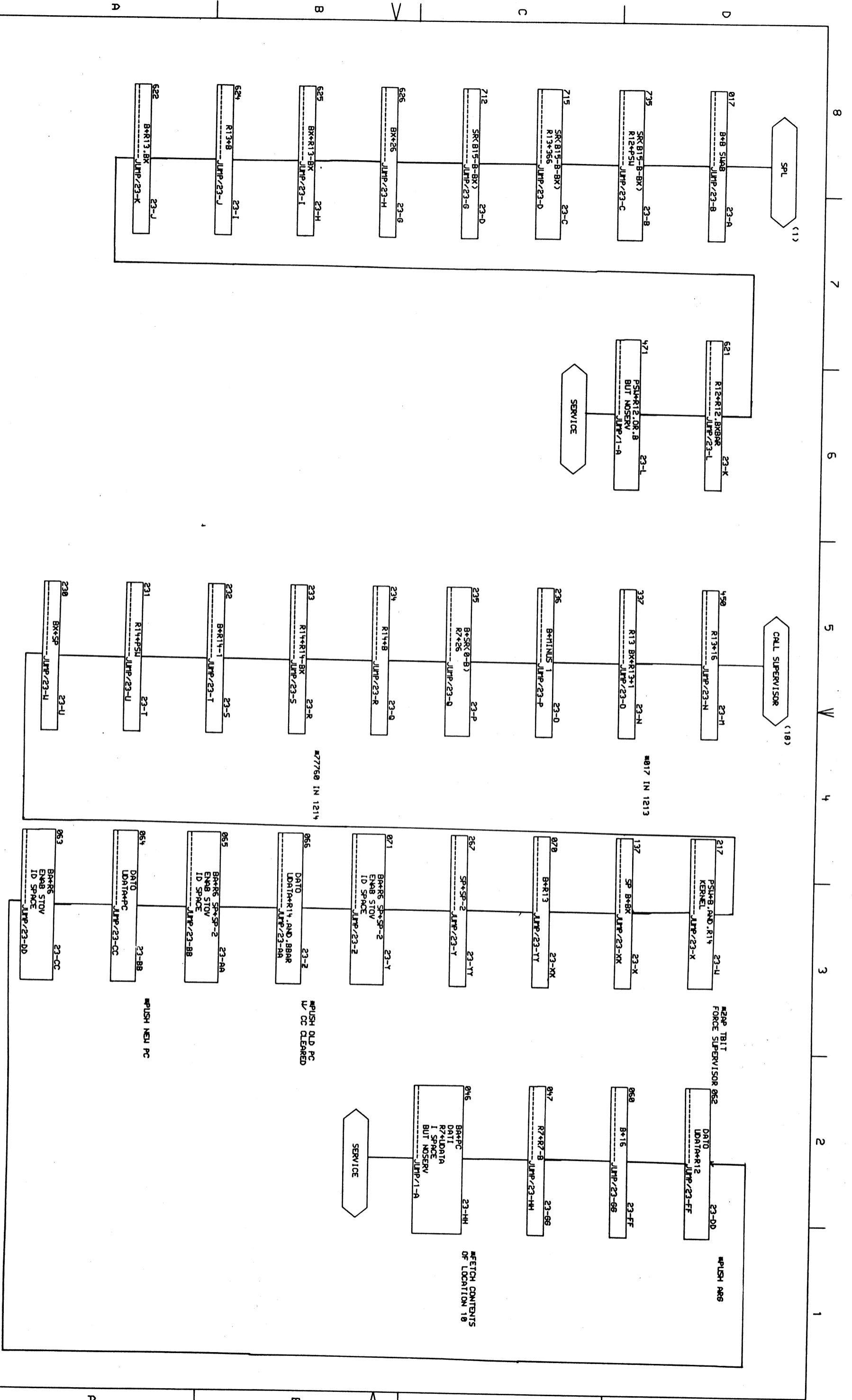

DN	DATE	BY	DATE	TITLE
CHK'D	DATE	BY	DATE	KD11-2 FLOW
DATE	DATE	BY	DATE	DIAGRAMS
DATE	DATE	BY	DATE	NUMBER
DATE	DATE	BY	DATE	REV.
DATE	DATE	BY	DATE	B
DATE	DATE	BY	DATE	8
DATE	DATE	BY	DATE	7
DATE	DATE	BY	DATE	6
DATE	DATE	BY	DATE	5
DATE	DATE	BY	DATE	4
DATE	DATE	BY	DATE	3
DATE	DATE	BY	DATE	2
DATE	DATE	BY	DATE	1

DK:PAGE23.TZPC.160.512/J128/JUN/29/1251 NEXT HIGHER ASSEMBLY  
FIRST USED ON OPTION/MODEL: 11/74 B-DD-KD11-2-C

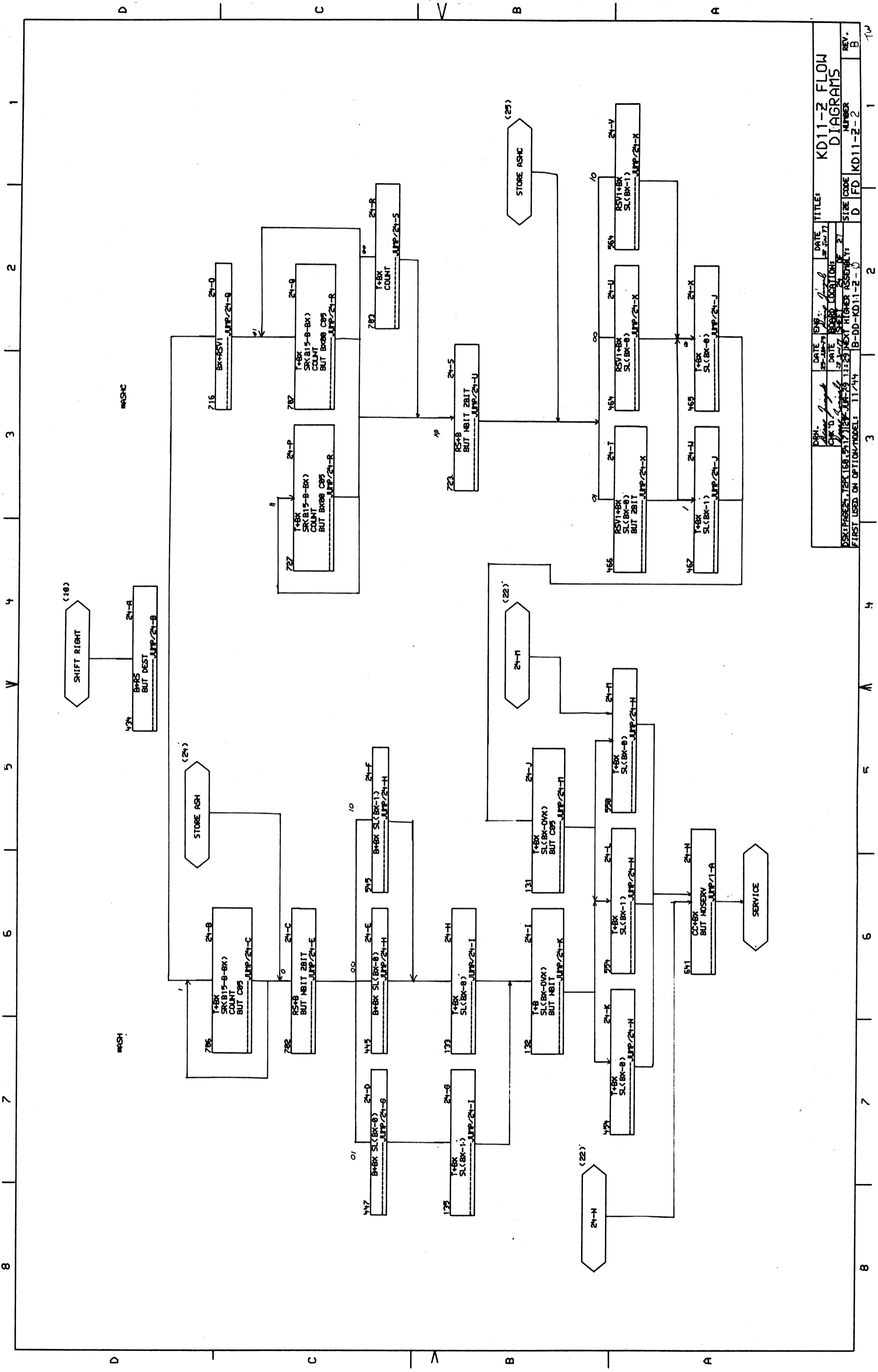

DATE	BY	DESCRIPTION	DATE	BY	DESCRIPTION
11/24/44	B-D	DD-KD11-2-0	11/24/44	B-D	DD-KD11-2-0
11/24/44	B-D	DD-KD11-2-0	11/24/44	B-D	DD-KD11-2-0
11/24/44	B-D	DD-KD11-2-0	11/24/44	B-D	DD-KD11-2-0

DSK: PAPER 25, TYP: 168, 2517, JTB: 4, 2517, 11/24/44, 11/24/44, 11/24/44, 11/24/44  
 FIRST USED ON OPTION MODEL: 11/24/44 B-DD-KD11-2-0  
 TITLE: KD11-2 FLOW DIAGRAMS  
 SIZE CODE: D FD  
 NUMBER: 1  
 REV. B

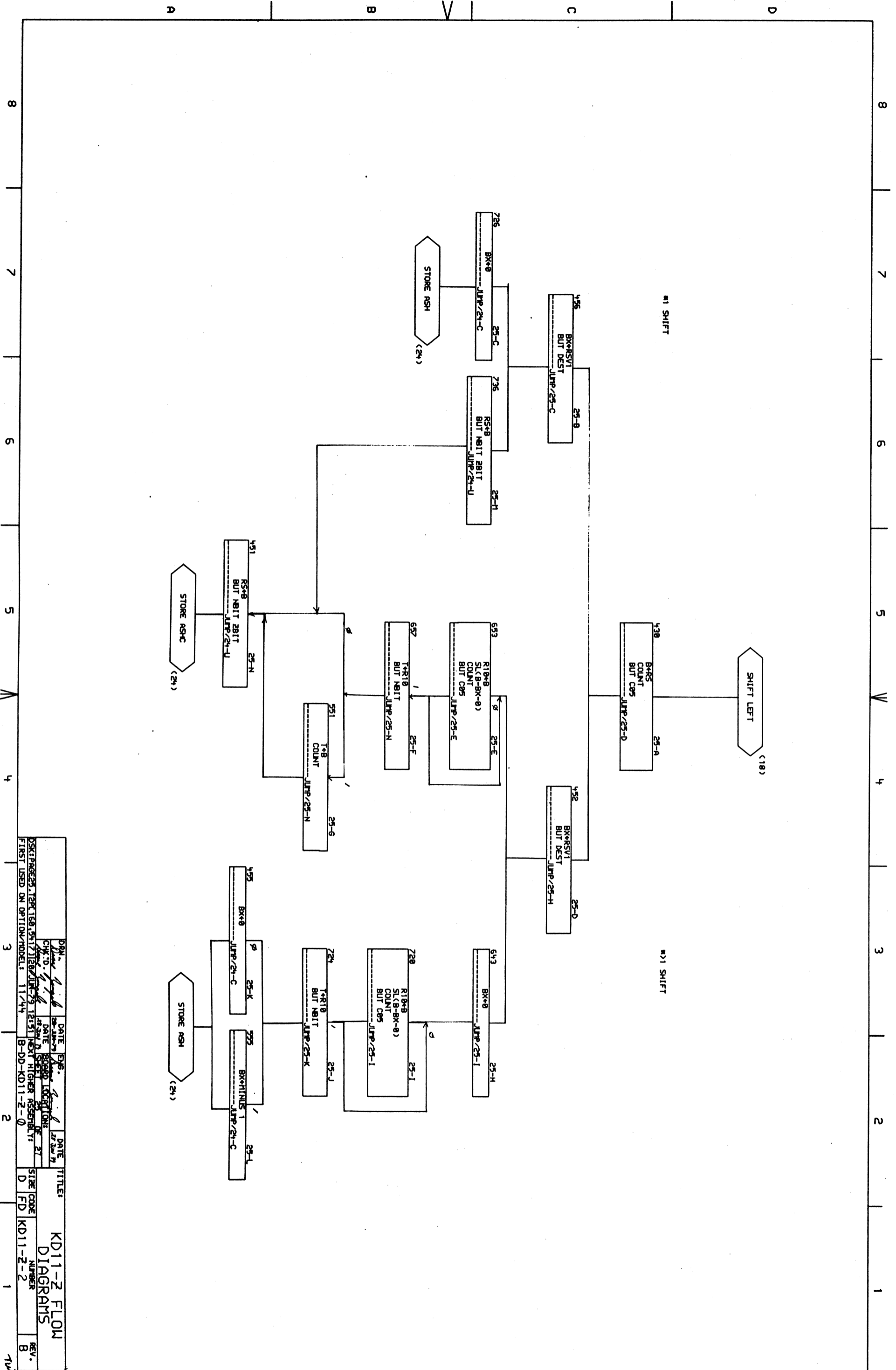

DGM		DATE		DATE		TITLES	
CHK'D		DATE		DATE		KD11-2 FLOW	
DATE		DATE		DATE		DIAGRAMS	
DATE		DATE		DATE		NUMBER	
DATE		DATE		DATE		REV.	
DATE		DATE		DATE		B	
DATE		DATE		DATE		1	
DATE		DATE		DATE		2	
DATE		DATE		DATE		3	
DATE		DATE		DATE		4	
DATE		DATE		DATE		5	
DATE		DATE		DATE		6	
DATE		DATE		DATE		7	
DATE		DATE		DATE		8	

DSK:PAGE25 12PK 158,517,128/JUN-79 12151  
 FIRST USED ON OPTION-MODEL: 11/74  
 B-DD-KD11-2-0



THIS DRAWING AND ITS CONTENTS ARE UNCLASSIFIED AND THE INFORMATION CONTAINED HEREIN IS UNCLASSIFIED EXCEPT WHERE SHOWN OTHERWISE. IT IS THE POLICY OF THE NATIONAL ARCHIVES AND RECORDS ADMINISTRATION TO RELEASE ALL INFORMATION CONTAINED HEREIN TO THE PUBLIC UNLESS INDICATED OTHERWISE.

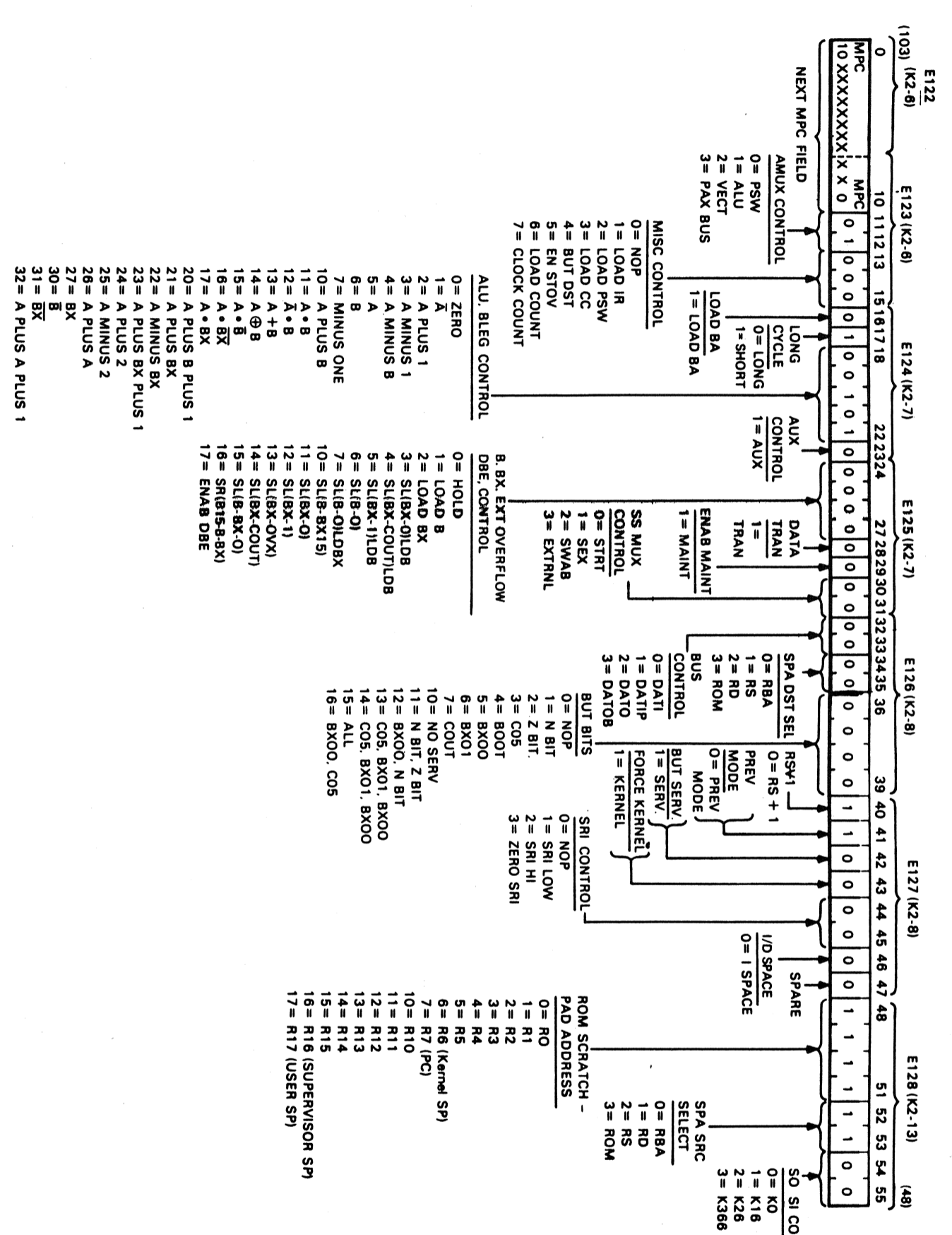

(CONTROL WORD FIELD DEFINITIONS)

REVISION HISTORY		
DATE	ECO NUMBER	REV.

DATE	BY	TITLE	SCALE
17-APR-81	S. STEARN	KDII-Z FLOW	1
17-APR-81	B. GIST	KDII-Z-2 DIAGRAM	1
17-APR-81	B. GIST		1
17-APR-81	B. GIST		1