

PrintServer 17 Printer

Maintenance Kit Guide

Order Number: EK-PRT17-MG. A01

First Printing, February 1993

The information in this document is subject to change without notice and should not be construed as a commitment by Digital Equipment Corporation. Digital Equipment Corporation assumes no responsibility for any errors that may appear in this document.

The software described in this document is furnished under a license and may be used or copied only in accordance with the terms of such license.

No responsibility is assumed for the use or reliability of software on equipment that is not supplied by Digital Equipment Corporation or its affiliated companies.

Restricted Rights: Use, duplication, or disclosure by the U.S. Government is subject to restrictions as set forth in subparagraph (c)(1)(ii) of the Rights in Technical Data and Computer Software clause at DFARS 252.227-7013.

© Digital Equipment Corporation 1993.

All Rights Reserved.
Printed in U.S.A.

The postpaid Reader's Comments forms at the end of this document request your critical evaluation to assist in preparing future documentation.

The following are trademarks of Digital Equipment Corporation: DECnet, DECprint, PrintServer, ULTRIX, VAX, VMS, and the DIGITAL logo.

PostScript™ is a trademark of Adobe Systems Incorporated, which may be registered in certain jurisdictions.

All other trademarks and registered trademarks are the property of their respective holders.

S2258

This document was prepared using VAX DOCUMENT, Version 2.1.

Contents

Preface	v
1 Maintenance	
1.1 Replacing the Toner Cartridge	1-2
1.2 Performing 200K Maintenance	1-3
1.2.1 Replacing the Pickup Rollers	1-4
1.2.2 Replacing the Duplex Unit Reversing Roller	1-10
1.2.3 Replacing the Transfer Charge Roller	1-13
1.2.4 Replacing the Fusing Unit	1-21
1.2.5 Resetting the Maintenance Counter	1-31
1.3 Cleaning the Printer	1-32
Index	

Preface

This guide describes how to perform 200K maintenance on the PrintServer 17 printer. This information is also in Chapter 5 of the *PrintServer 17 Printer Operator's Guide*.

Conventions

The following terms and conventions are used in this guide:

Term or Convention	Meaning
NOTE	Notes provide important additional information.
CAUTION	Cautions provide information required to prevent damage to equipment.
WARNING	Warnings provide information to prevent personal injury.
Dash (—)	<p>A statement preceded by a dash describes the result of a step. For example:</p> <ol style="list-style-type: none">1. Insert the paper cassette into the printer. <ul style="list-style-type: none">— The Error indicator shuts off.— The display reads Ready.
Check Mark (✓)	<p>A statement marked by a check mark indicates a special instruction related to a step. For example:</p> <ol style="list-style-type: none">1. Insert a small stack of paper (about 100 sheets) into the cassette first, being sure it is inserted below the bottom row of maximum height arrows on the label. <ul style="list-style-type: none">✓ Make sure the paper lies perfectly flat in the cassette.
Key	<p>A key enclosed in a box indicates that you press that key on the operator panel. Key names are always shown in initial capital letters. For example:</p> <ol style="list-style-type: none">1. Press Pause to pause the printer.
Bold	<p>Messages are shown bolded. For example:</p> <ul style="list-style-type: none">— The display reads Ready.— The display reads Add paper.

Term or Convention	Meaning
Toner Cartridge	This manual refers to the cartridge containing the toner as the toner cartridge. In addition to toner, this cartridge also contains a photo-sensitive drum, the primary charge roller, a drum cleaning blade, and a toner application roller. The model designation for this cartridge is “EP-N”, and it is designed specifically for the PrintServer 17 printer. For purposes of clarity, this manual will refer to the EP-N cartridge as the toner cartridge.

Printer Safety

Be sure to observe the following safety precautions when operating and servicing the PrintServer 17 printer:

WARNING

- This printer weighs 44 kg (97.1 lbs). To prevent personal injury do not attempt to move it by yourself. Two people are required to move the printer.
 - Be sure the front and rear power switches are in their off positions before connecting or disconnecting cables to the printer.
 - Power off and unplug the printer before performing the cleaning and maintenance procedures.
 - Do not modify the AC power cord. A Protective Earth wire has been incorporated into this printer to protect against the risk of electrical shock. This printer must be connected to a three-wire wall receptacle that has its Protective Earth terminal reliably connected to the building's protective earth connection.
 - The fusing unit in the printer may be HOT. Wait until the fusing unit has cooled down before maintaining or troubleshooting the printer.
-

Laser Safety

The PrintServer 17 printer complies with laser product performance standards by government agencies as a Class 1 Laser Product. The PrintServer 17 printer does not emit hazardous light, since the beam is enclosed during all modes of customer operation and maintenance.

Warning

Use of controls or adjustment procedures other than those specified in this guide may result in hazardous laser light exposure.

1

Maintenance

This chapter contains the following information:

- Replacing the toner cartridge (Section 1.1)
- Performing 200K maintenance (Section 1.2)
 - Replacing the pickup rollers (Section 1.2.1)
 - Replacing the duplex unit reversing roller (Section 1.2.2)
 - Replacing the transfer charge roller (Section 1.2.3)
 - Replacing the fusing unit (Section 1.2.4)
 - Resetting the maintenance counter (Section 1.2.5)
- General cleaning of the printer (Section 1.3)

1.1 Replacing the Toner Cartridge

The toner cartridge is typically replaced under the following conditions:

- To remedy a print quality problem (see Chapter 7 in the *PrintServer 17 Printer Operator's Guide*).
- When the Supplies Needed indicator lights and pressing displays the **Toner low - see Operator's Guide** message.

When the **Toner low** message is initially displayed, the toner cartridge may still contain enough toner to print additional pages before you have to replace the cartridge. Perform the following steps before replacing the cartridge:

1. Remove the toner cartridge and gently rock it a few times to redistribute the remaining toner (refer to Illustration 1 on the toner cartridge label inside the printer).
2. Reinstall the toner cartridge and print a job.
 - ✓ If the Supplies Needed indicator remains on or the print is too light, install a new toner cartridge (refer to instructions on the toner cartridge box).

NOTE

The toner cartridge is also known as an “EP-N” cartridge, which is the specific model designation assigned to the PrintServer 17 printer (see Conventions in the Preface). See Appendix C in the *PrintServer 17 Printer Operator's Guide* for information about ordering the toner cartridge.

1.2 Performing 200K Maintenance

Maintenance is required at 200K page intervals to ensure peak printer performance. The Supplies Needed indicator lights and the message **Perform user maintenance** is displayed.

Perform the following tasks at 200K-page intervals:

- Replace the six pickup rollers
- Replace the duplex unit reversing roller (if your printer has a duplex unit)
- Replace the transfer charge roller
- Replace the fusing unit
- Reset the maintenance counter

All replacement parts are in the 200K maintenance kit, which also includes a pair of protective rubber gloves. See Appendix C in the *PrintServer 17 Printer Operator's Guide* for information about ordering the 200K maintenance kit.

After performing 200K maintenance, reset the maintenance counter (see Section 1.2.5) and clean the printer (see Section 1.3).

WARNING

Power down and unplug the printer before performing any type of maintenance to prevent a possible electrical shock.

The fusing unit in the printer may be HOT and needs time to cool down before it can be handled. Wait at least 30 minutes after powering off the printer before attempting to replace the fusing unit.

1.2.1 Replacing the Pickup Rollers

Replace the six pickup rollers using the following procedure:

Note

To prevent paper jams, always replace all six pickup rollers at the same time. Do not mix old and new rollers together.

1. Power off both the front **1** and rear **2** power switches on the printer.

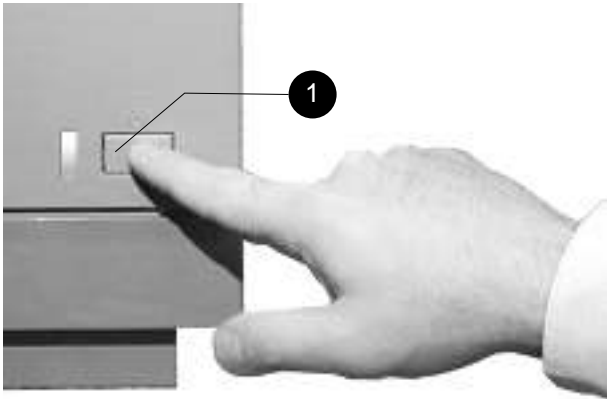

DSG-000241

2. Unplug the power cord from the wall outlet.

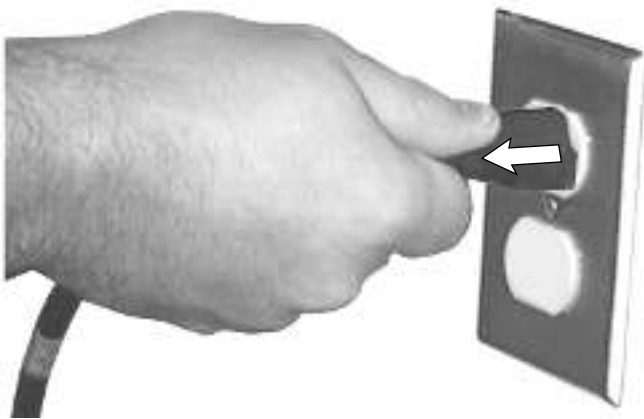

DSG-000238

3. Remove the top and bottom paper cassettes by lifting them up slightly and then pulling them out of the printer.



DSG-000234

4. Put on the rubber gloves supplied in the maintenance kit.

CAUTION

Be sure that you are wearing the rubber gloves to avoid contaminating the new rollers and getting toner on your hands.

5. Remove each roller by pinching its tab and then sliding the roller off its shaft.

✓ Discard the old rollers.

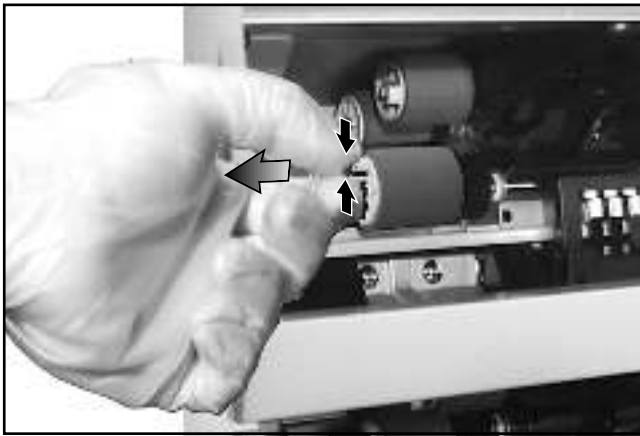

DSG-000247

6. Install each new pickup roller by sliding it onto its shaft until it “clicks” into place.
 - ✓ Make sure each roller is properly installed by trying to slide it off its shaft; the roller should not slide off the shaft.



DSG-000246

7. If you have a duplex unit installed in your printer, go to Section 1.2.2 to continue with 200K maintenance.

If you do not have a duplex unit in your printer, continue with the next step.

8. Insert the top and bottom paper cassettes.



MLO-009515C

9. Go to Section 1.2.3 to continue with 200K maintenance.

1.2.2 Replacing the Duplex Unit Reversing Roller

Replace the duplex unit reversing roller using the following procedure:

1. Remove the duplex unit reversing roller by lifting the bottom paper tray arm **1**, pinching the roller tab, and then sliding the roller off its shaft **2**.
✓ Discard the old roller.

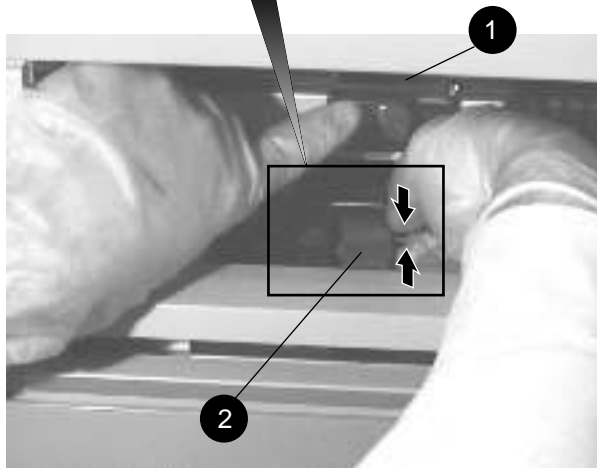
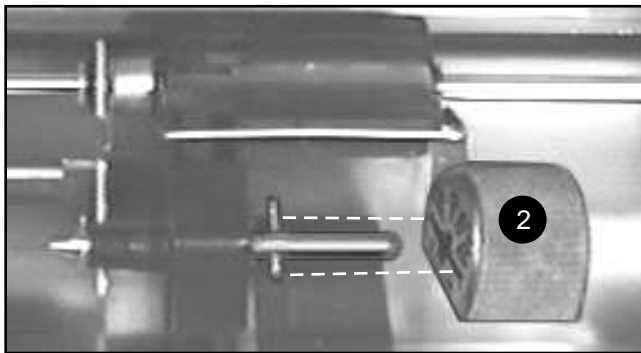

DSG-000248

2. Install the new roller (flat side down) by sliding it onto its shaft until it “clicks” into place.
 - ✓ The alignment pin ❶ on the metal shaft fits into the slot ❷ in the roller.
 - ✓ Make sure the roller is properly installed by trying to slide it off the shaft; the roller should not slide off the shaft.

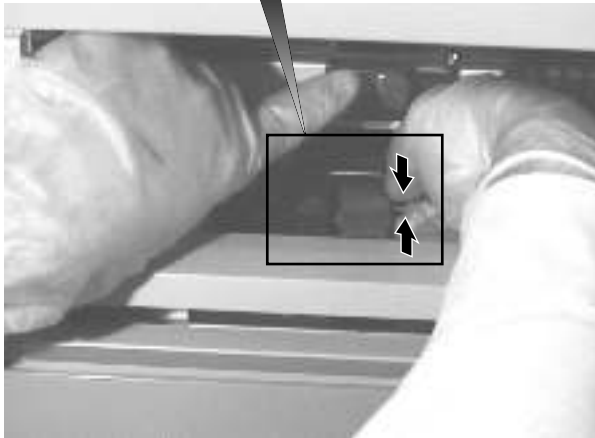
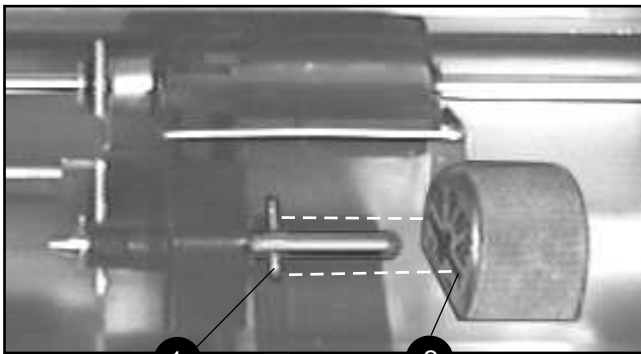

DSG-000249

3. Insert the top and bottom paper cassettes.



MLO-009515C

4. Go to Section 1.2.3 to continue with 200K maintenance.

1.2.3 Replacing the Transfer Charge Roller

Replace transfer charge roller using the following procedure:

CAUTION

Contaminating the roller with oil from your fingers results in print quality problems. Be sure that you are wearing the rubber gloves supplied in the maintenance kit to avoid contaminating the new roller and getting toner on your hands.

Do not remove the protective covering wrapped around the charge roller until instructed to do so.

1. Slide the release button forward **1** and open the cover **2**.

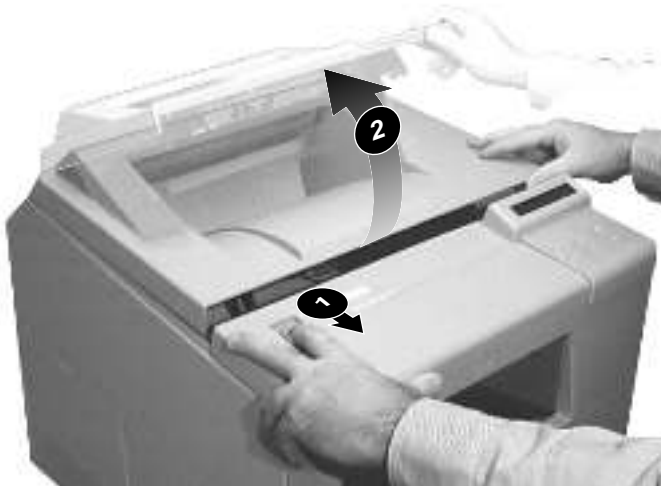

MLO-009501C

2. Remove the toner cartridge from the top cover.
✓ Lift the top cover to its full open position.

CAUTION

To avoid damaging the photosensitive drum in the cartridge, cover the cartridge with a sheet of paper and store it in an area out of direct light (for example, in a desk or file cabinet drawer).



DSG-000250

3. Lift the blue retaining clip **1** from the right side of the transfer charge roller.
✓ Discard the retaining clip.
4. Slide the black support guide **2** to the right to disengage the roller.

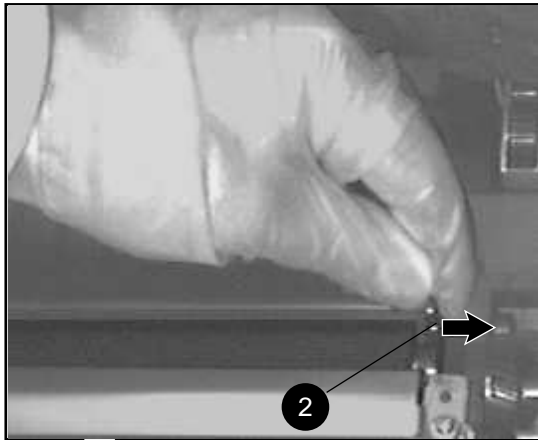

DSG-000252

5. Remove the roller by lifting it up and out of the printer.
✓ Discard the roller.

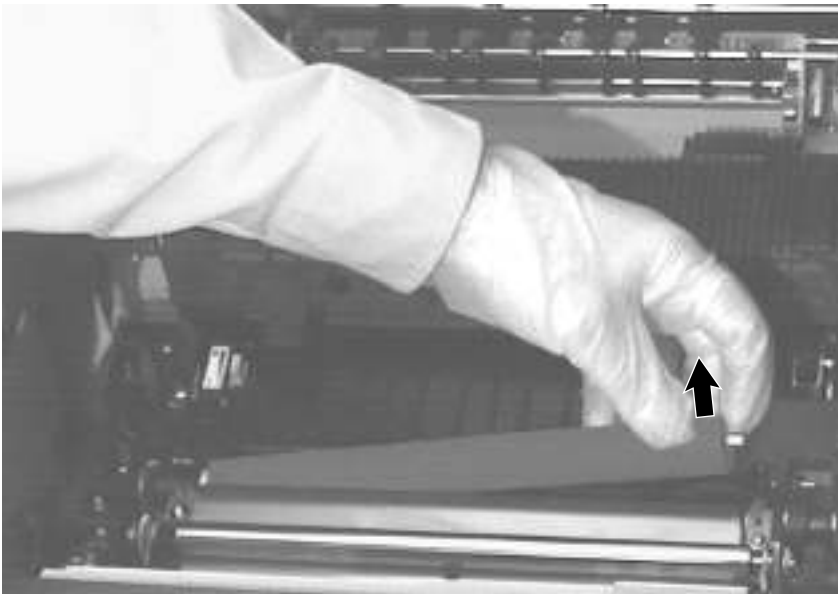

DSG-000253

6. Insert the alignment pin **1** on the left side of the roller the into the slot **2** of the black plastic gear.

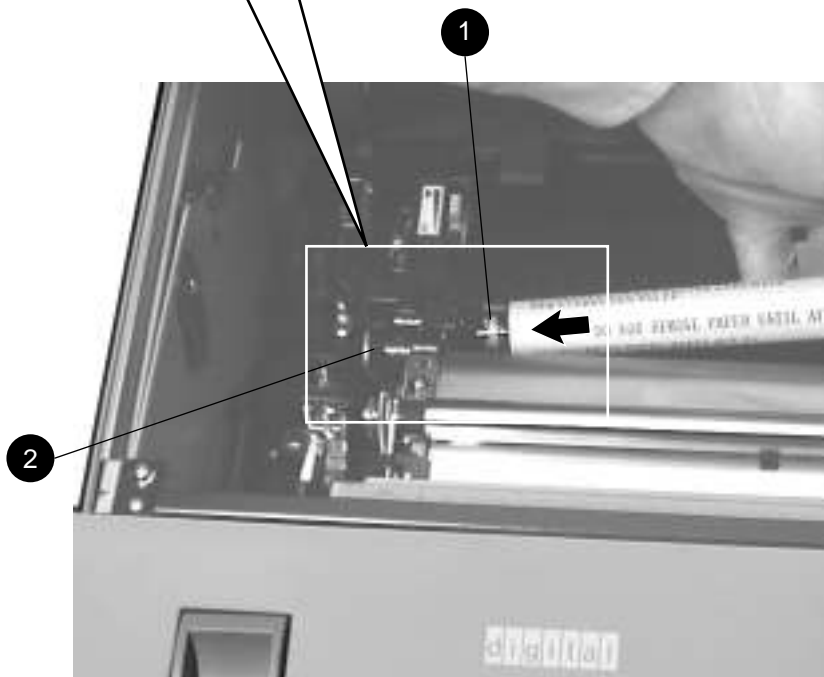
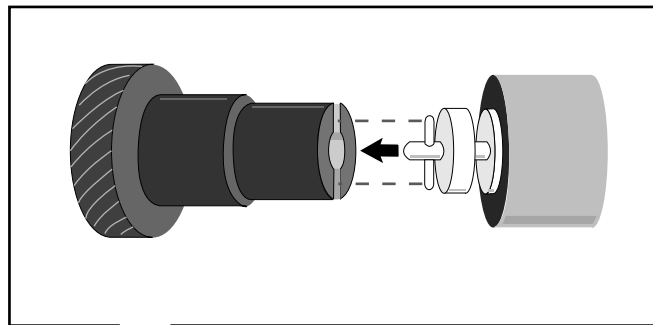

DSG-000254

7. Lower the right side of the roller and slide the support guide **1** over the metal pin at the end of the roller.
8. Insert the new blue retaining clip **2** and push down until it snaps into place.

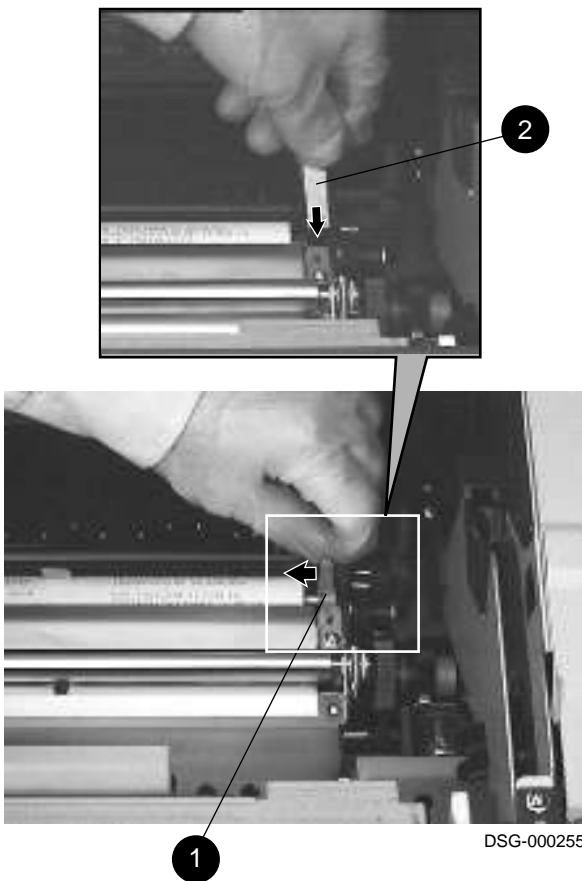

9. Remove the protective covering from the new roller by peeling back the tape and pulling the cover straight up off the roller.

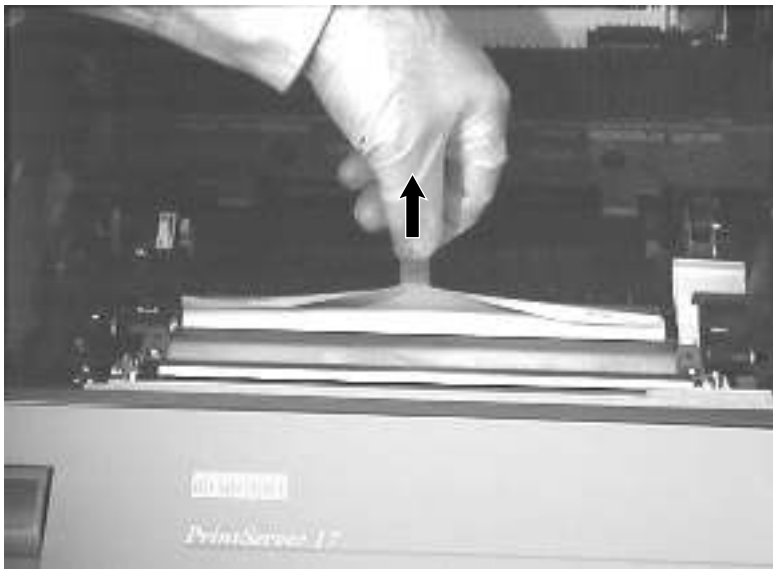

DSG-000256

10. Check to see that the roller is installed properly by moving the black plastic gear ❶ back and forth with your finger; the roller should rotate back and forth when you move the gear.

✓ If the roller does not rotate, reinstall it and check again. The roller rotates very easily when properly installed.

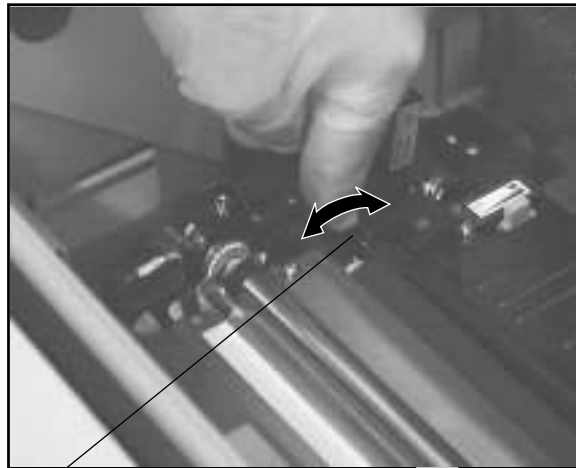

DSG-000257

11. Go to Section 1.2.4 to continue with 200K maintenance.

1.2.4 Replacing the Fusing Unit

Replace the fusing unit using the following procedure:

WARNING

The fusing unit in the printer may be HOT and needs time to cool down before it can be handled. Wait at least 30 minutes after powering off the printer before attempting to replace the fusing unit.

1. Remove the four fusing unit screws **1** with a flat-bladed screwdriver.
✓ These screws will be used again when installing the new fusing unit.
Note that one screw is fitted with a special grounding washer **2**.

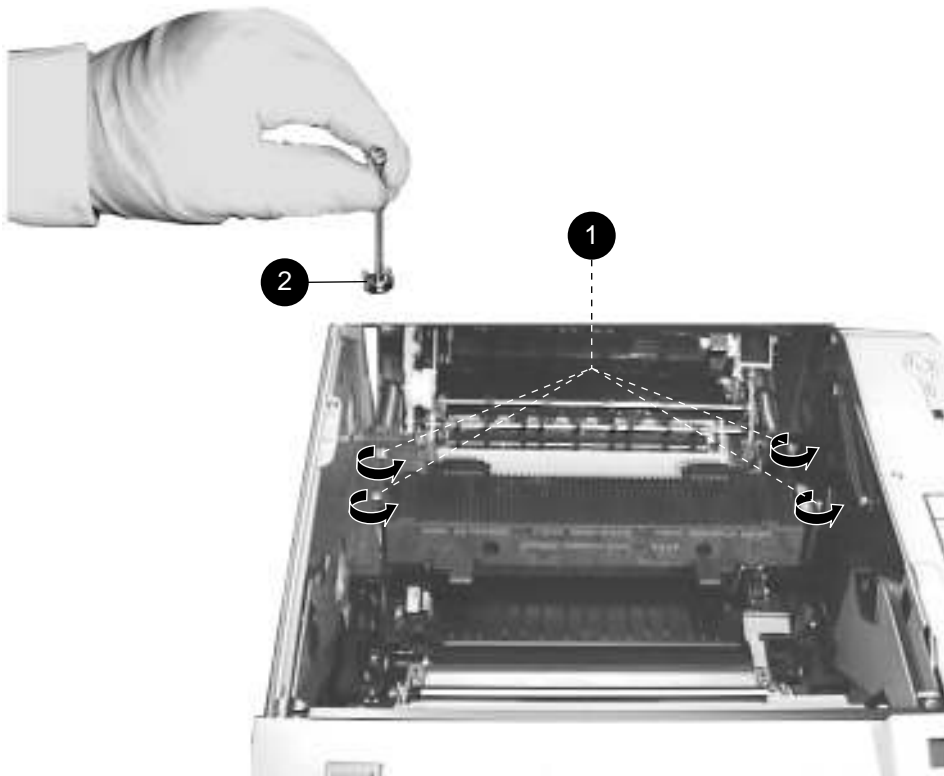

DSG-000258

2. Remove the fusing unit by sliding it to the left **1** and then lifting it up and out of the printer **2**.
- ✓ Discard the old fusing unit.

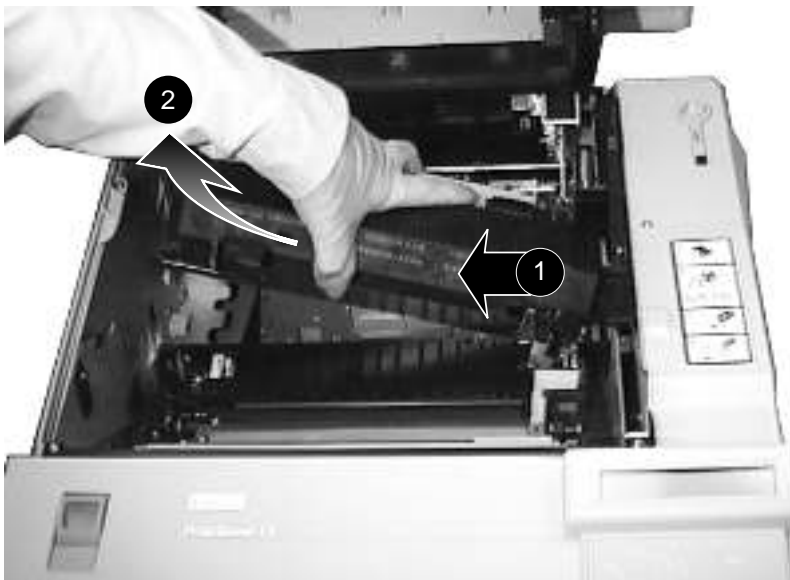

DSG-000259

3. Remove and discard the plastic shipping spacers **1** from the new fusing unit.

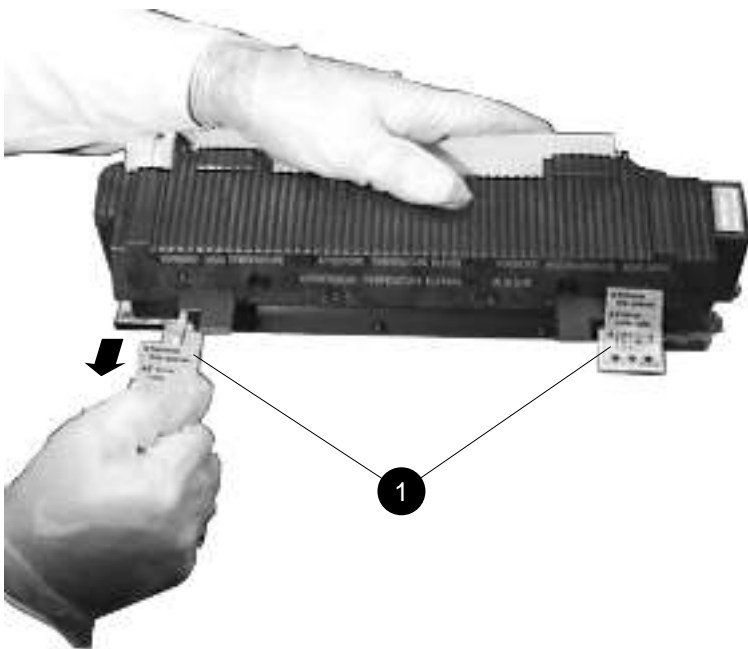

DSG-000260

4. Open the green fusing unit access cover **1** and lift the tape to pull out the sheet of plastic shipping material.
✓ Close the fusing unit access cover.

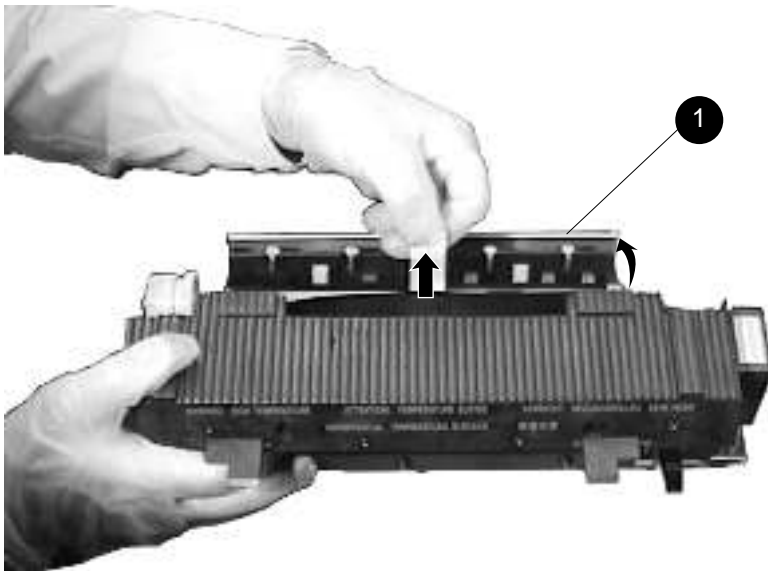

DSG-000285

5. Install the new fusing unit into the printer by inserting the right side first and then lowering it into place.
6. Gently slide the fusing unit to the right to plug it into its electrical connector.

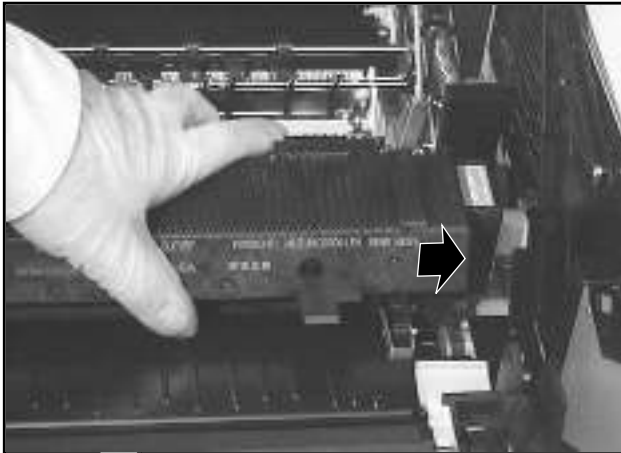

DSG-000261

7. Insert the four screws and finger tighten only.
 - ✓ Note the location of the screw containing the special grounding washer ❶.
8. With a flat-bladed screwdriver, tighten the four screws until snug.

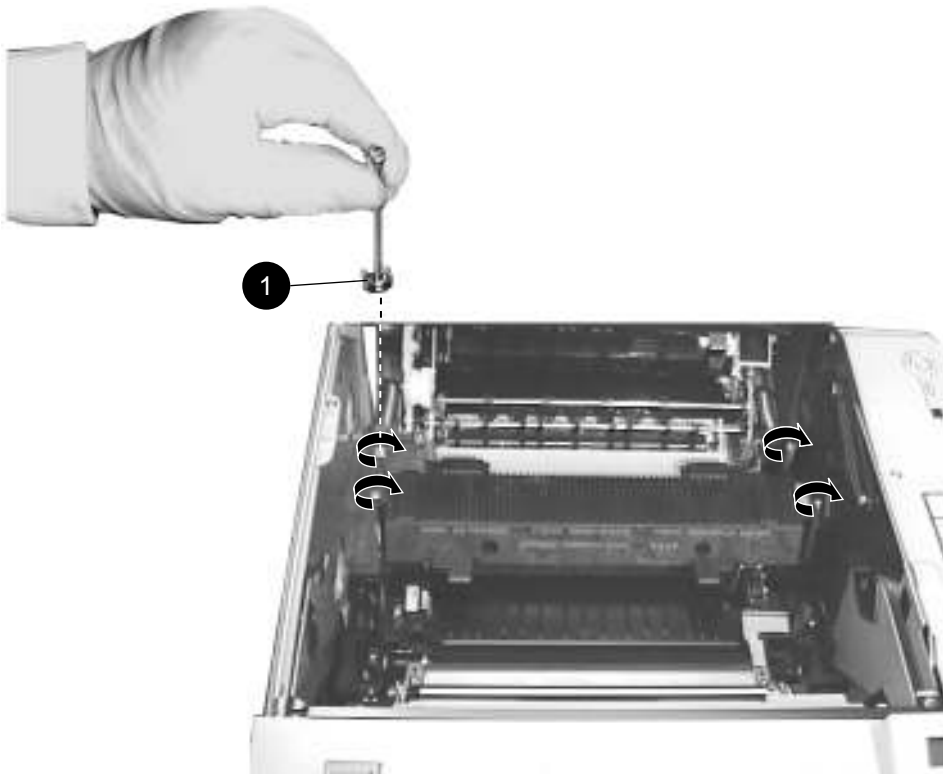

DSG-000262

9. Reinstall the toner cartridge.



DSG-000286

10. Gently lower the top cover and push down on the cover until it locks in place.

- ✓ Be sure to lower the top cover gently. Letting the top cover drop down causes toner to leak out of the toner cartridge.



MLO-009509C

11. Plug the power cord into the wall outlet.

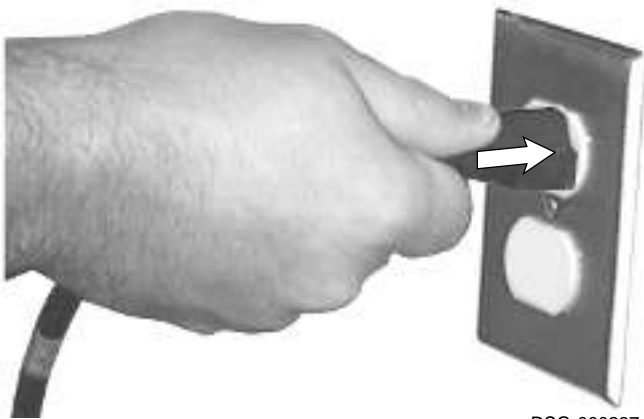

DSG-000237

12. Power on the rear ❶ and front ❷ power switches.

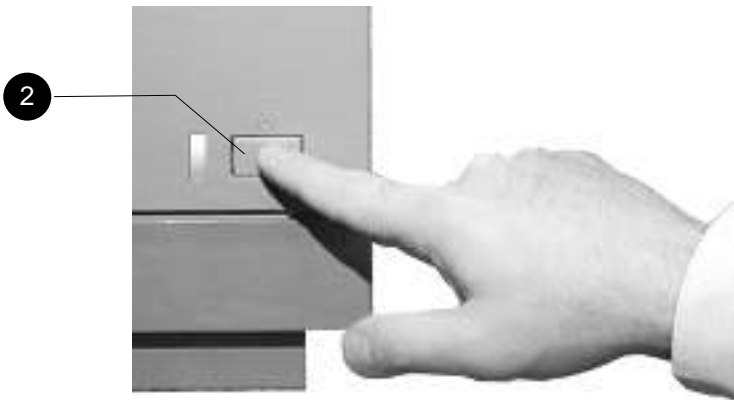

DSG-000242

13. Go to Section 1.2.5 to continue with 200K maintenance.

1.2.5 Resetting the Maintenance Counter

After you have completed 200K maintenance, reset the maintenance counter, using the following procedure:

1. Press **[Pause]** to place the printer off line.
 - After a moment the display reads:
Paused–
Press Resume to continue
2. Press **[Test Set-up]** to enter Test Set-up Mode.
 - The keypad is now in Test Set-up Mode and the keys take on their numeric values.
After a moment the display reads:
Press [4] to reset
maintenance counter
3. Press **[4]**.
 - The display reads:
Reset maintenance
Enter code:
4. Enter the following code:
[2], [5], [3].
 - After a moment the printer exits Test Set-up Mode and the display reads:
Paused–
Press Resume to continue
5. Press **[Resume]** to place the printer back on line.
 - The display reads:
Ready
 - ✓ This completes the 200K maintenance for the PrintServer 17 printer.
 - ✓ To ensure top print quality, perform a general cleaning of the printer at this time (see Section 1.3).

1.3 Cleaning the Printer

To ensure the highest possible print quality, it is important that you clean the PrintServer 17 printer periodically. Cleaning the PrintServer 17 printer is a simple matter of wiping off excess toner and paper dust with a clean lint-free cloth lightly dampened with water.

The following events can be used as appropriate timetables to clean the printer:

- Each time you change the toner cartridge
- When print quality problems persist
- Each time you perform 200K maintenance

WARNING

Always power down and unplug the printer before cleaning the printer to prevent a possible electrical shock.

The fusing unit may be HOT. Allow enough time for the printer to cool down before cleaning the inside of the printer.

CAUTION

Do not use cleaning solvents or detergents to clean the printer. Use a lint-free cloth slightly dampened only with water.

Clean the printer using the following procedure:

1. Power off both the front **1** and rear **2** power switches on the printer.

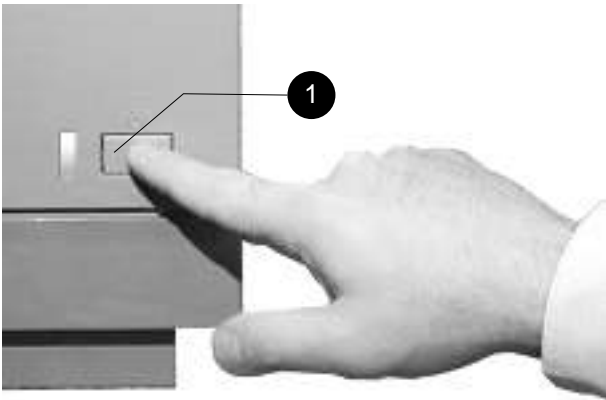

DSG-000241

2. Unplug the power cord from the wall outlet.

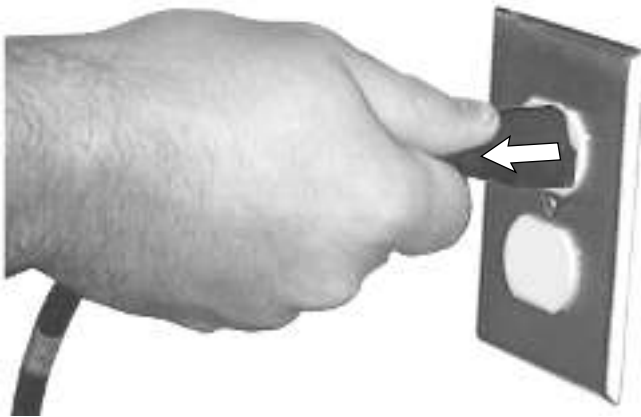

DSG-000238

3. Slide the release button forward **①** and open the cover **②**.

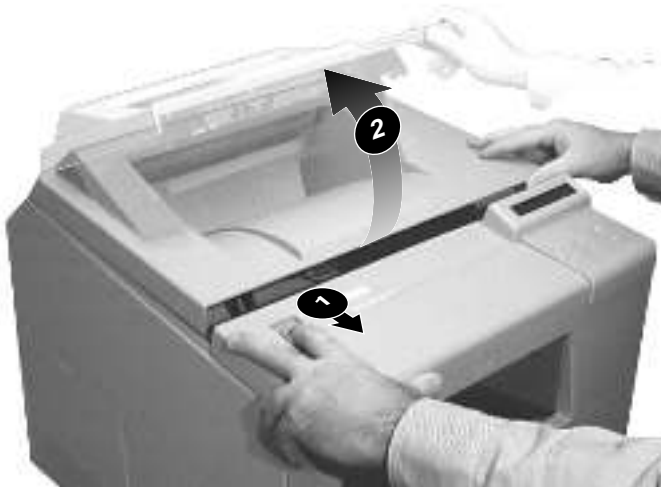

MLO-009501C

4. Clean the anti-static teeth using the cleaning brush (stored in the printer).

CAUTION

Be careful not to touch (or clean) the transfer charge roller when cleaning the anti-static teeth. Oil or contaminants from your fingers or scratches on the transfer charge roller will reduce print quality.

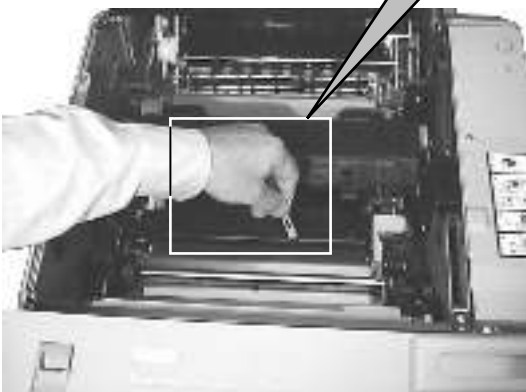

DSG-000263

5. Clean the upper transfer guide with a cloth dampened with water.



DSG-000274

6. Lift the upper transfer guide to its open position and wipe clean the lower transfer guide.



DSG-000264

7. Lower the upper transfer guide to its operating position.



MLO-009506C

8. Clean the paper transfer area.



DSG-000275

9. Gently lower the top cover and push down on both sides of the cover until it locks in place.
 - ✓ Be sure to lower the top cover gently. Letting the top cover drop down causes toner to leak out of the toner cartridge.



MLO-009509C

10. Plug the power cord into the wall outlet.

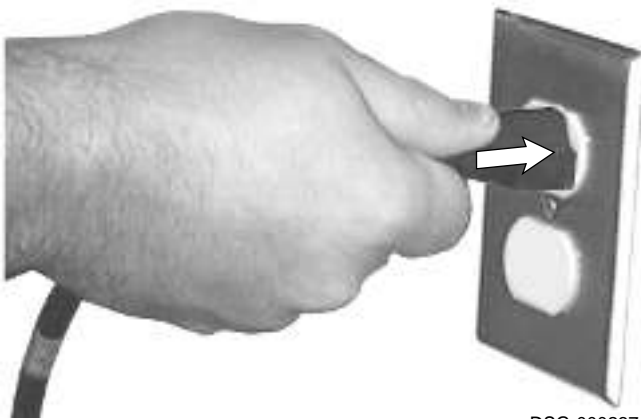

DSG-000237

11. Power on the rear ❶ and front ❷ power switches.

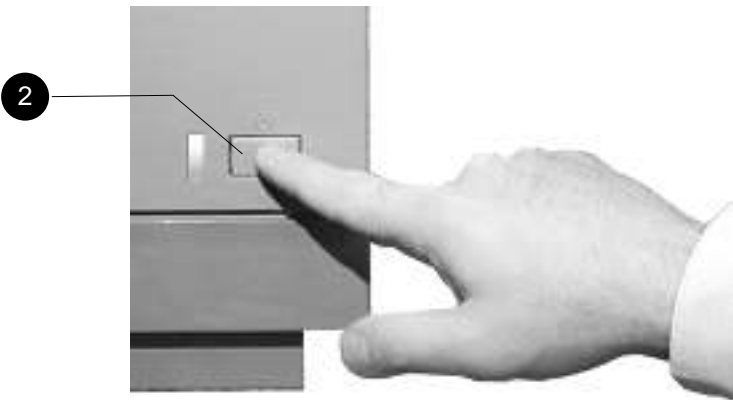

DSG-000242

Index

C

Cleaning
printer, 1–32
Conventions, vi

D

Duplex unit reversing roller
replacing, 1–10

F

Fusing unit
replacing, 1–21

L

Laser safety, ix

M

Maintenance, 1–1
cleaning, 1–32
200K, 1–3
replacing the duplex unit reversing roller,
1–10
replacing the fusing unit, 1–21

replacing the pickup rollers, 1–4
replacing the transfer charge roller, 1–13
Maintenance counter
resetting, 1–31

P

Pickup rollers
replacing, 1–4
Printer maintenance, 1–1
Printer safety, viii

R

Replacing the toner cartridge, 1–2

S

Safety
laser, ix
printer, viii

T

Toner cartridge, vi
replacing, 1–2
Transfer charge roller
replacing, 1–13

